

Assembly Instruction

Item No.: F8867, F8868, F8869

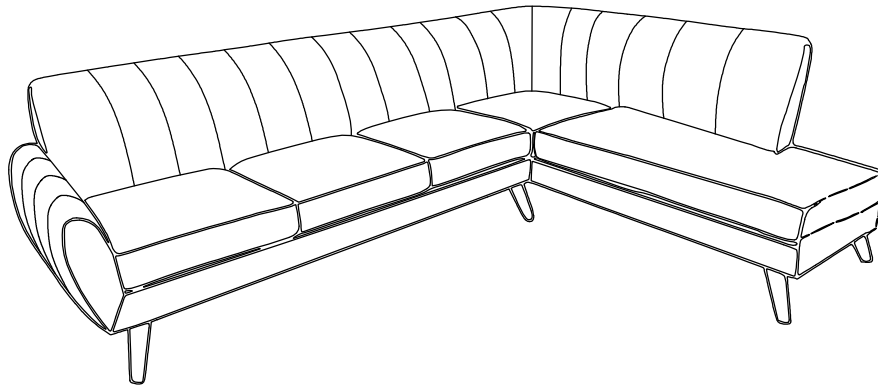

PART LIST

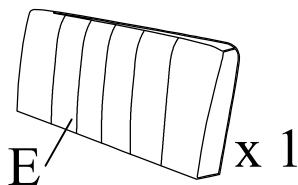
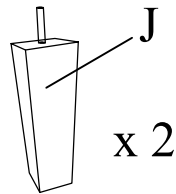
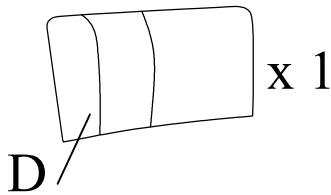
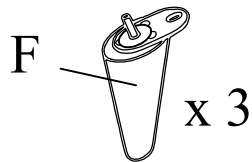
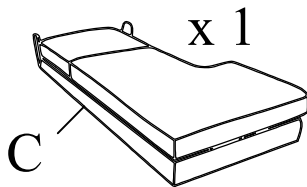

BOX 1:F8867-1, F8868-1, F8869-1

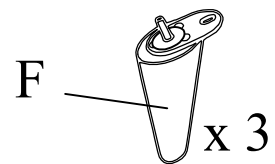
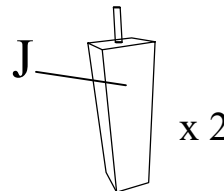
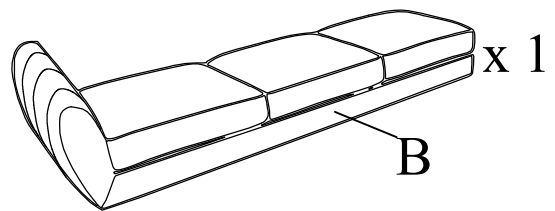
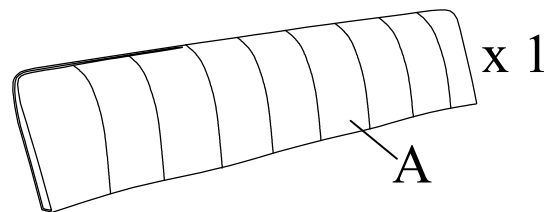

BOX 2:F8867-2, 8868-2, F8869-2

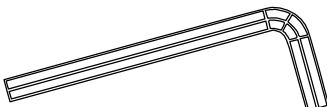

HARDWARE LIST

<p>①  x 6 Bolt 5/16" * 30mm</p>	<p>②  x 6 Lock Washer Ø5/16"</p>	<p>③  x 6 Flat Washer Ø5/16"</p>
<p>④  x1 Allen Wrench M4</p>		



Please follow the drawings below to assemble this item.

Step 1. Take out the legs from the inner box, and then rotate / tighten into the position at bottom of the left - facing sofa and the matching right - facing chaise as shown in below drawings.

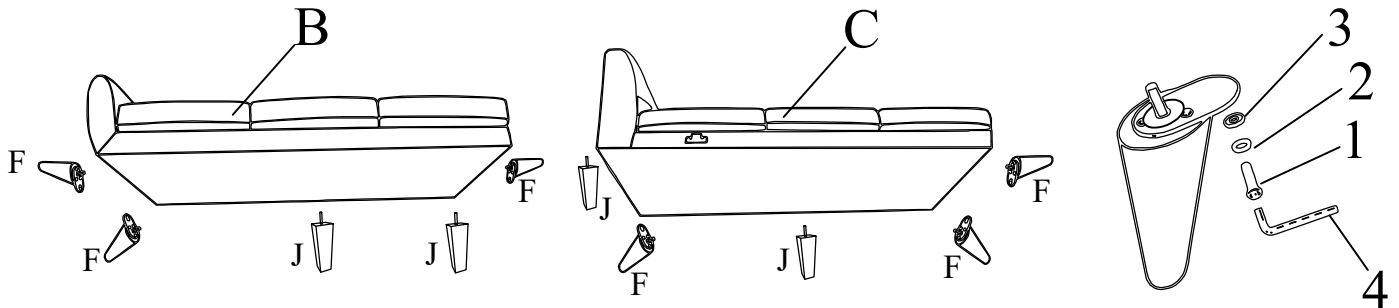

Step 2. Allign female brackets with the male one at the back & seat. And then insert / push the whole backrest to the seat. Make sure the brackets are secured in position before using.

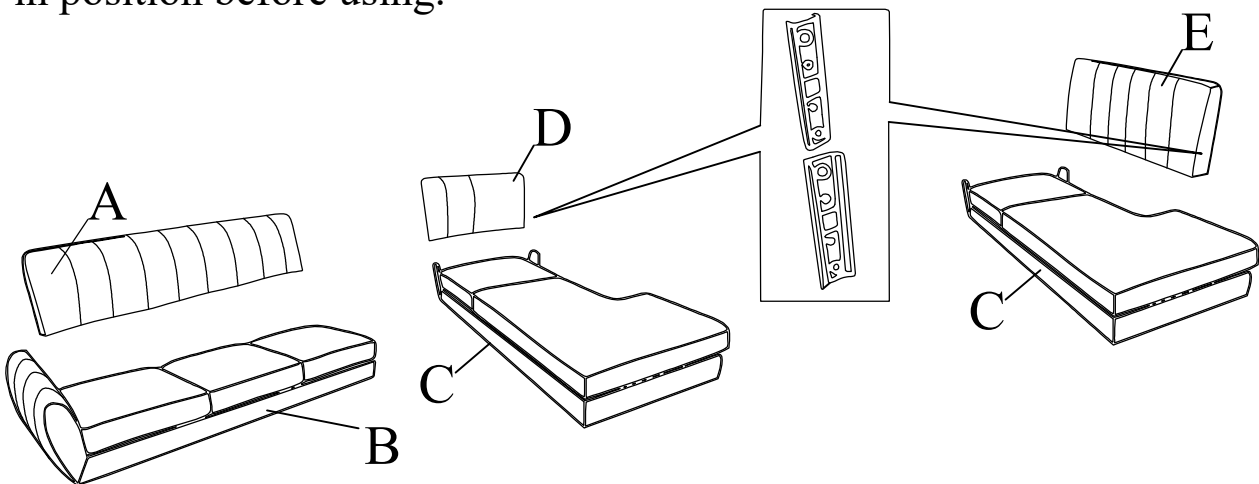

Step 3. Left - facing sofa and right - facing chaise can be attached together by the brackets as shown in below drawings.

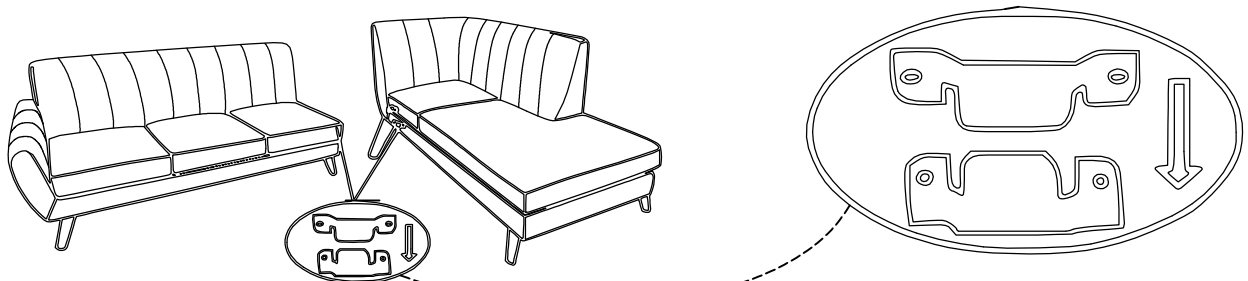

Step 4. Completed

