

Riverside

FURNITURE







email: info@riverside-furniture.com

Inspiration Retro Occasional Table Assembly Instructions

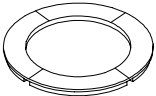
Made in Viet Nam

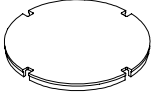
Be sure to check all packing material carefully for small parts, which may have come loose inside the carton during shipment.

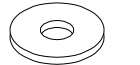
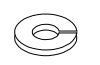
Component And Hardware List

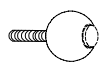
Top Assembly	Glass Top	Legs	Shelf	
				
(A) 1 PC.	(B) 1 PC.	(C) 4 PCS.	(D) 1 PC.	
Bolt Ø5/16" x 2"	Flat Washer Ø5/16"	Spring Washer Ø5/16"	Allen Key	Glass Support
				
(E) 8 PCS.	(F) 8 PCS.	(G) 8 PCS.	(H) 1 PC.	(I) 4 PCS.

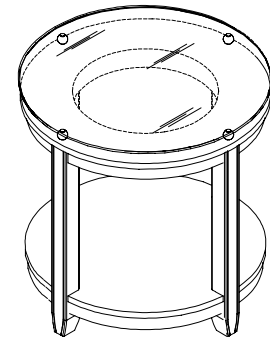

Round End Table
#80609

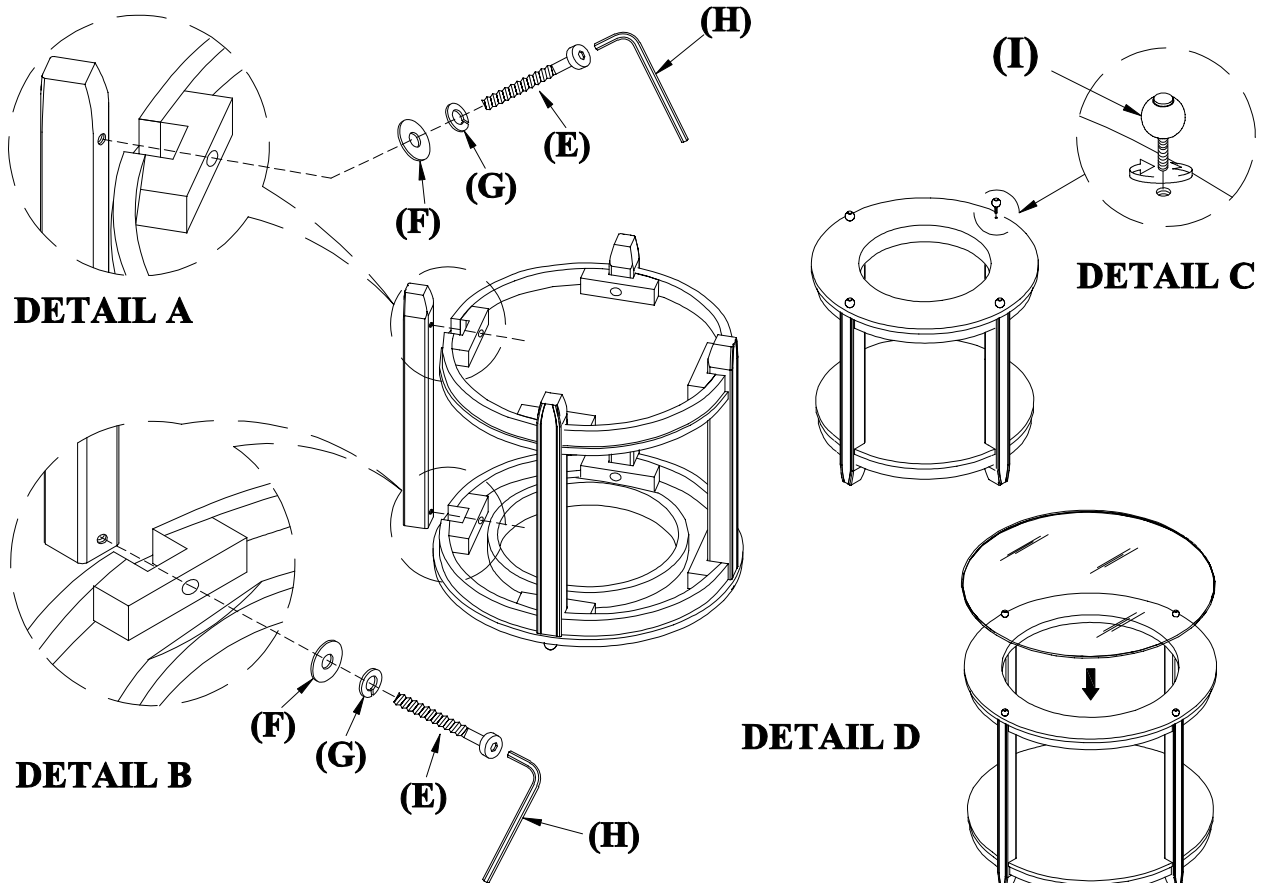

ASSEMBLY PROCEDURE:

- Place the Top Assembly (A) upside down, and assemble the entire table on a soft and smooth surface.
- Assemble four Legs (C) to the Shelf (D) by using Bolt (E) Spring Washer (G) & Flat Washer (F) as shown in **DETAIL A**. Do not fully tighten until after next step.
- Place and attach the assembled Legs & Shelf to the Top Assembly (A) by using Bolt (E) Spring Washer (G) & Flat Washer (F) as shown in **DETAIL B**.
- Tighten all Bolts using the Allen Key (H).
- Turn the assembled Table upright and assemble Glass Support (I) to the Top Assembly (A) as shown in **DETAIL C**.
- Carefully place the Glass Top (B) on the Top Assembly (A) with Glass Supports (I) as shown in **DETAIL D**.

THANK YOU FOR YOUR PURCHASE.