

Play Palace

read first REVIEW BEFORE ASSEMBLY

- **TOOLS:** Allen wrench is included. No other tools are necessary.

1 To attach **SCRATCHING POSTS** to the **DAY BED** and **ROUND PLATFORM**, you will need these pieces:

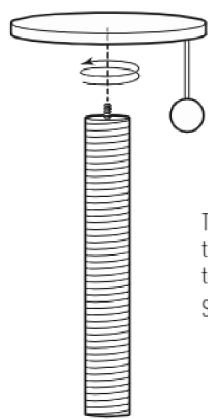
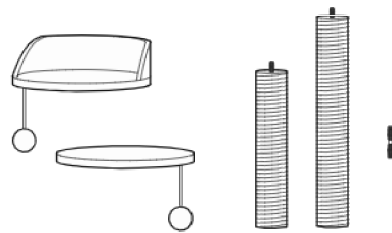

Twist the **tallest post** into the hole under the round platform to create a stable connection. Set this unit aside until Step 3.

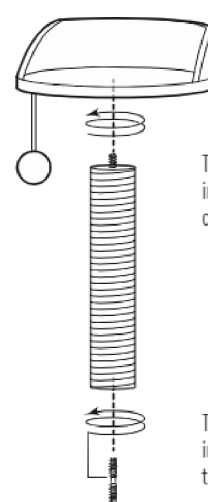

Twist a **short post** with screw-end into the hole under the day bed to create a stable connection.

Twist the two-ended screw post into the bottom—up to where the thread stops.

2 To add the **LOUNGING PLATFORM** and lower **SCRATCHING POSTS**, you will need these pieces:

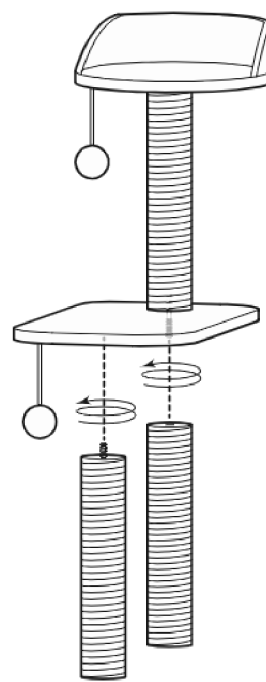
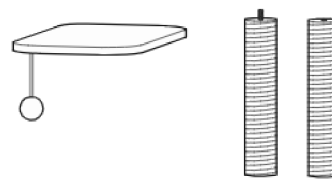

Insert the screw post of the day bed unit through the platform.

Twist a **short post** without screw-end onto the screw post to create a stable connection.

Twist the remaining **short post** with screw-end into the platform.

3 To attach the assembled units to the **BASE**, you will need these pieces:

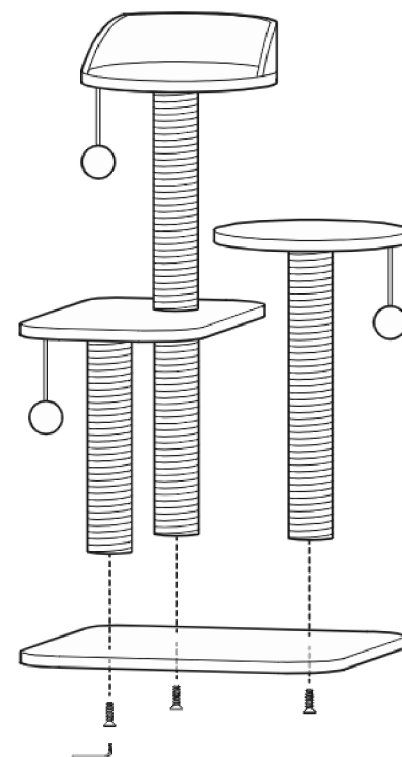
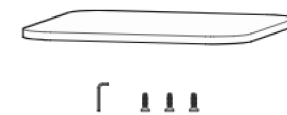

Add the assembled units to the base.

Tighten screws securely to create a stable connection.

