

INSTRUCTION

HARDTOP GAZEBO WITH NETTING 1220

If you have any questions about the hardtop gazebo with netting 1220, please feel free to contact us.
Customer Service Email: Service@alaulm.com

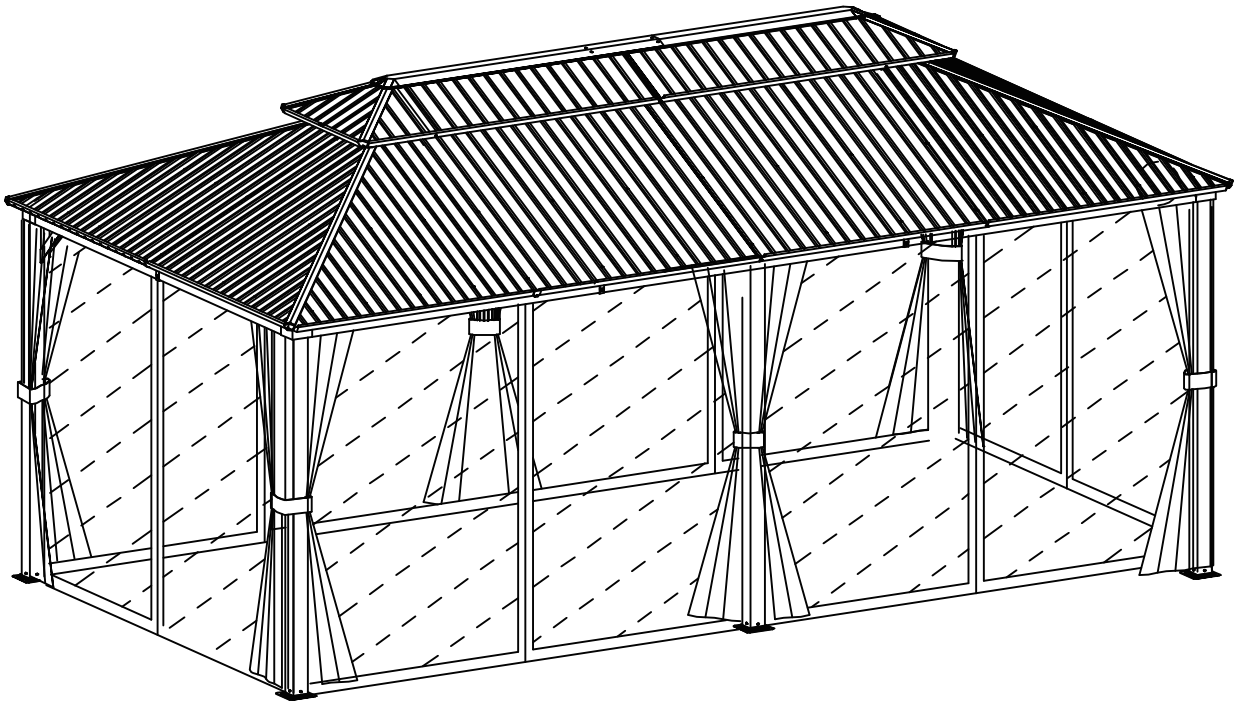

SKU:P25088-D1

IMPORTANT

PLEASE READ BEFORE YOU COMMENCE ASSEMBLY

Follow the guidelines in this user guide to ensure correct
assembly and care for this product.

Catalog

Notice 03

Warning 03

Specifications 05

Exploded Views 06

Part List 08

Extra 10

How to Assemble the hardtop gazebo with netting 122011

NOTICE

Please prepare below tools before installation.

The following tools are not included and needed for assembly:



Pistol Drill



Tape Measure



Ladder

Package included Tools:

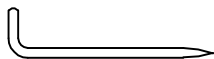

Screw Driver



Gloves

Warning

We recommend two adults to complete the installation. Two adults installed together will make the installation process easier and safer.

The gloves must be carried to prevent hand cuts during installation. Take care when using power tools near water the use of a residual current device(RCD) is advised. Please use the electric driver carefully during screwing to prevent the screw from slipping and hurting your hand.

We recommend that beginners use a manual screwdriver for installation.

Be careful not to fall when installing the roof. Please steady the ladder and make sure the product placed on a flat ground.

PLEASE KEEP THIS INSTRUCTION FOR FUTURE REFERENCE.

PLEASE RETAIN THESE INSTRUCTIONS FOR FUTURE REFERENCE.

Dear Customer,

Thank you for shopping with us!

When you receive the product, please make sure that all the parts are intact. Then please browse the entire installation manual before assembling.

If any problem occurs unsatisfactorily as follows:

- A.The outer box is damaged
- B.The product is damaged / bent / cracked while you open the box
- C.The parts / accessories / assembly tools are missing
- D.The product is hard to assemble
- E. The instructions are not clear and can not be referred
- F.The product has functional problems
- G.Other aspects that you are not satisfied with

Please feel free to contact us for help. Our after-sales team service (**Service@alaulm.com**) will reply within 24 hours and will do our best to resolve the problem for you.

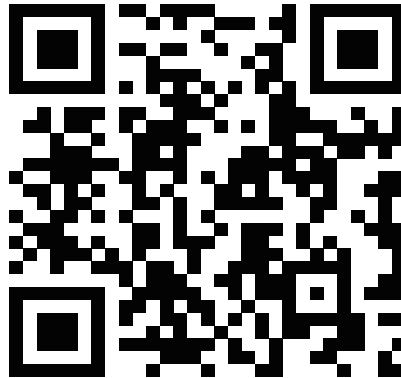

Attention:

- 1.Please fix all the screws first,do not lock them off,after assembling is fully completed, lock all at once finally.
- 2.Please check the manual carefully and make sure you have received all the parts.
- 3.If there is any missing,please let us know the letter of the parts you need.
- 4.If there is any damage,please send clear photos to us,and we will check and offer you best solution soon.

SPECIFICATIONS

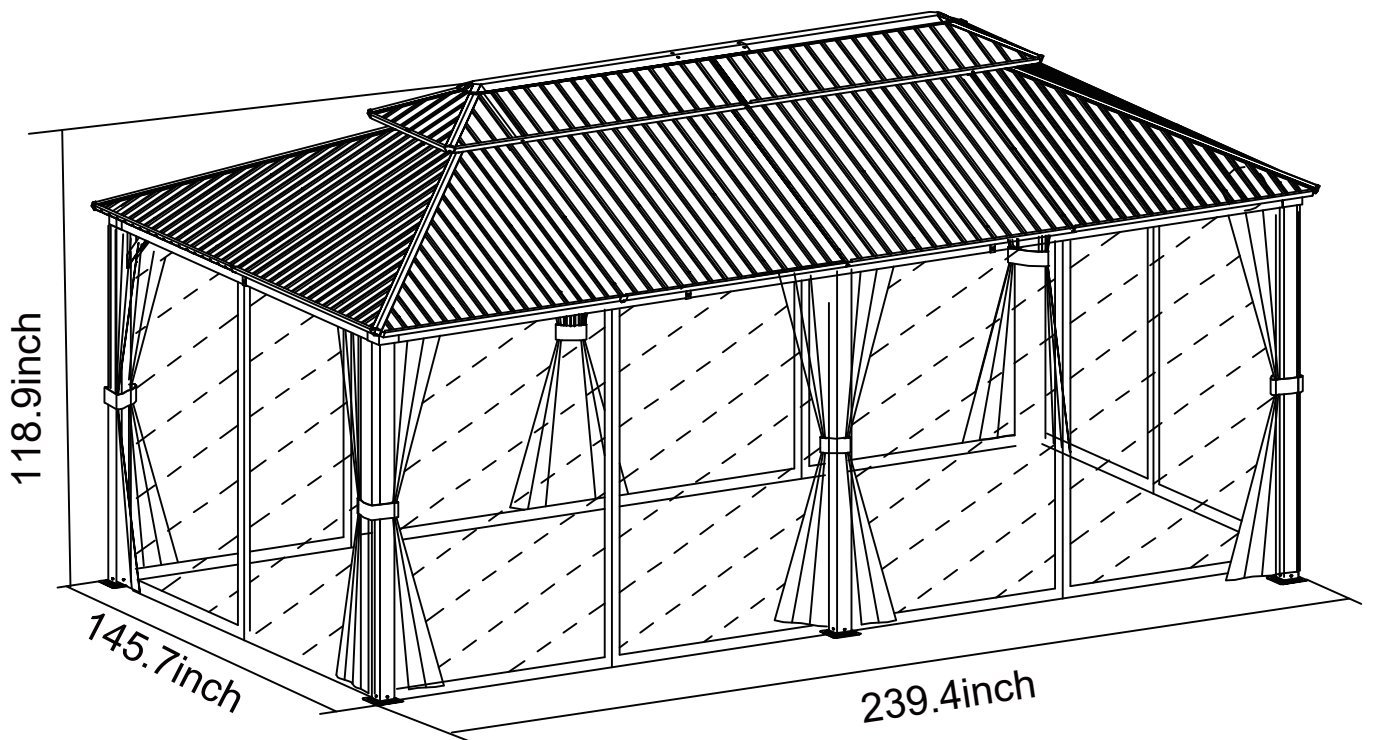

HARDTOP GAZEBO WITH NETTING 1220

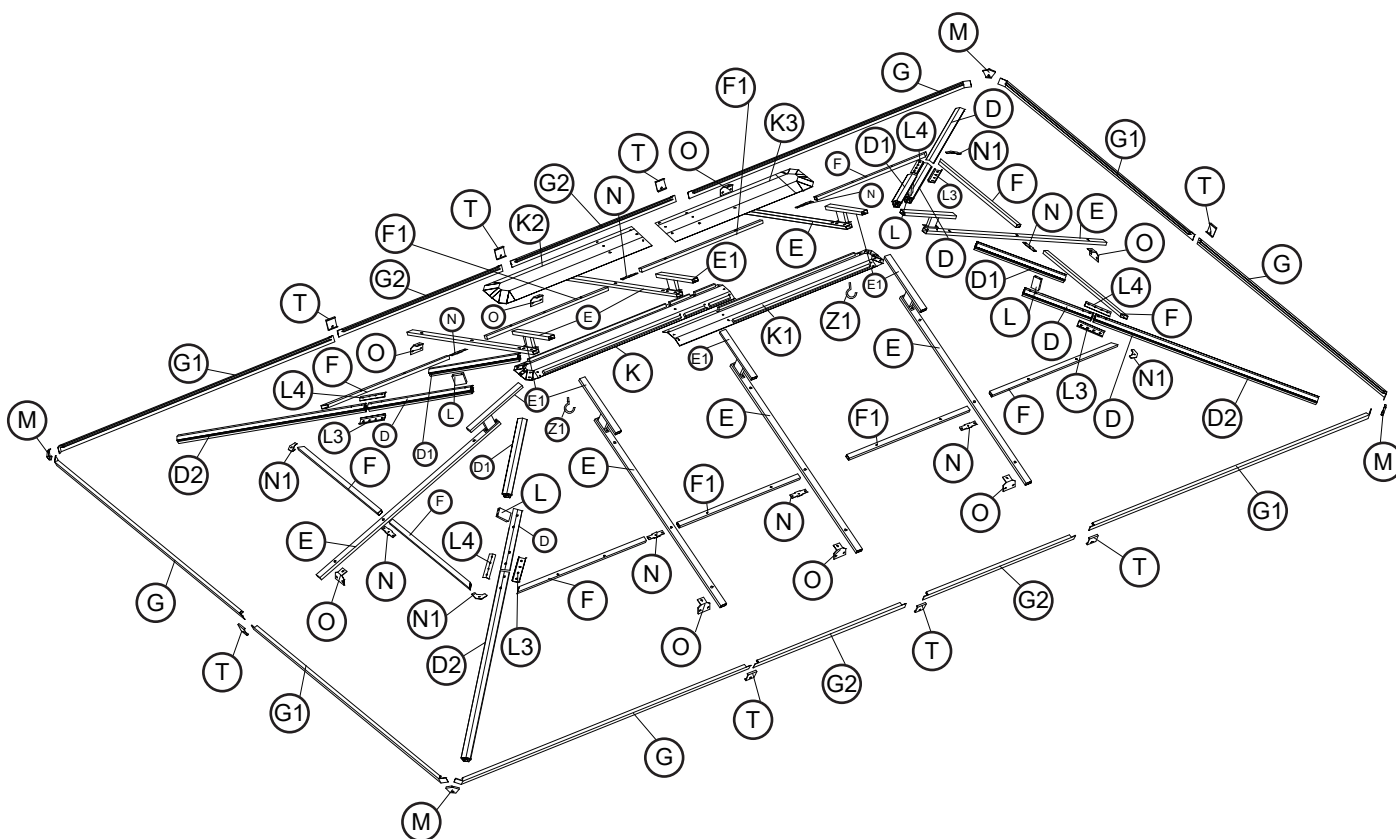
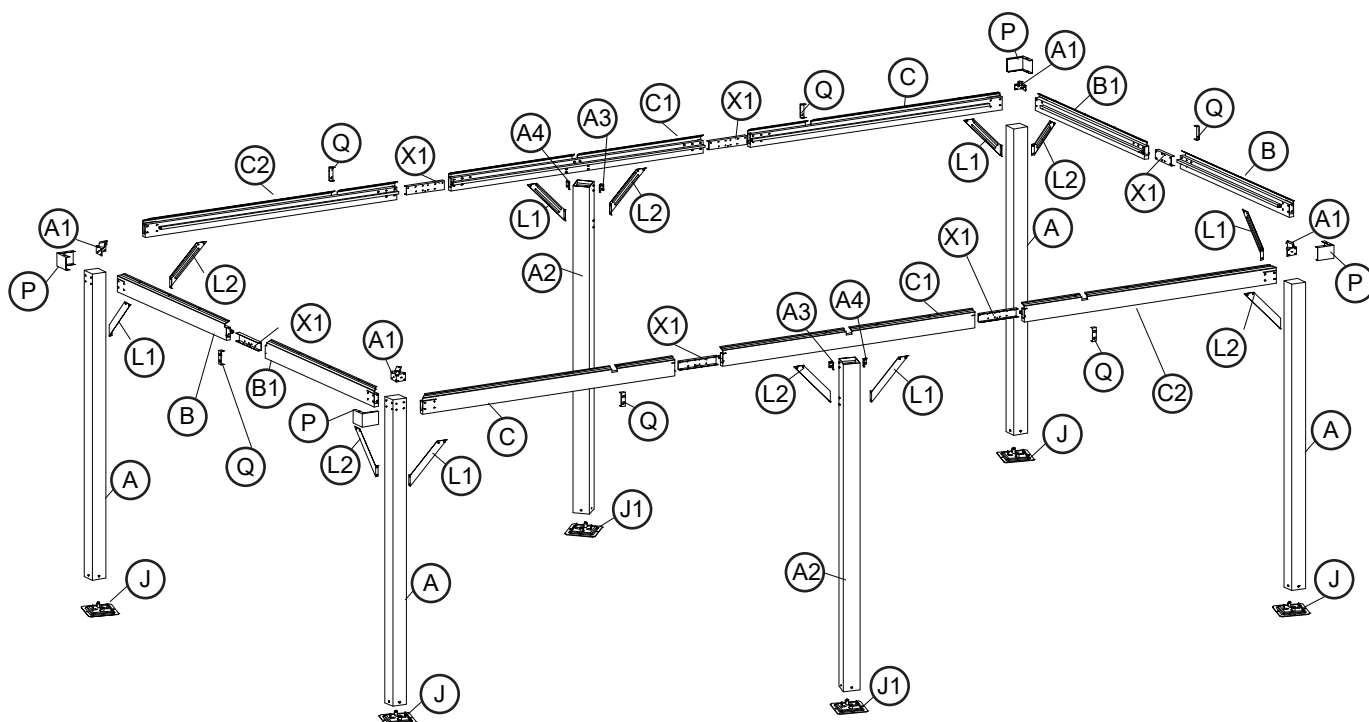



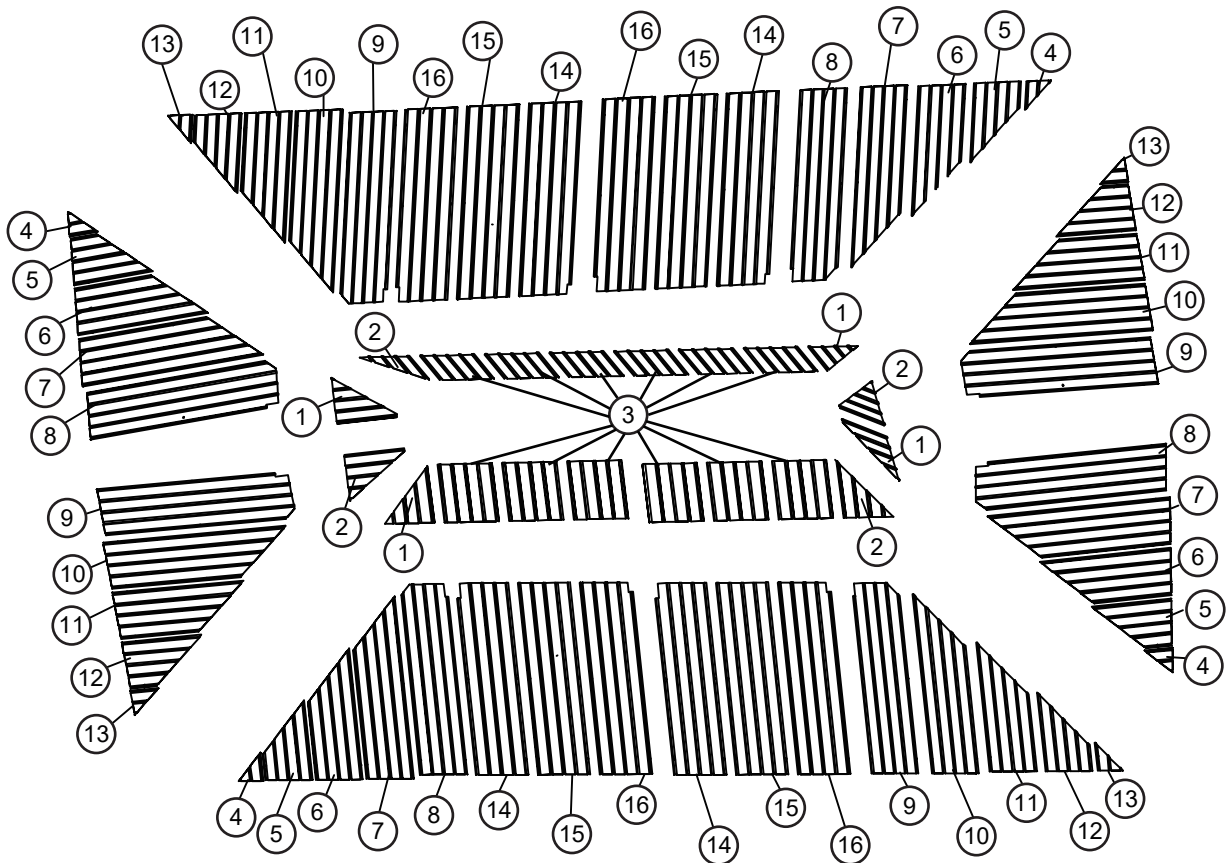
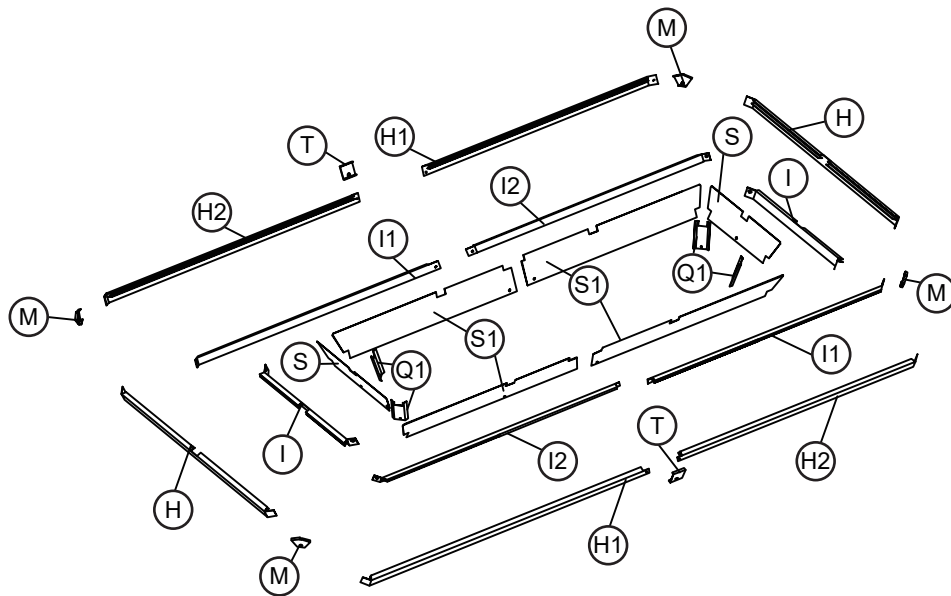



EXPLODED VIEW

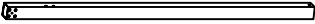















PART LIST







PART LIST(BOX A)

Label No.	PART	Qty	Label No.	PART	Qty
A		4	E		8
D		4	D1		4
D2		4	S1		4





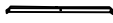





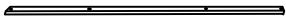

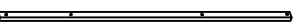
PART LIST(BOX B)

Label No.	PART	Qty	Label No.	PART	Qty
A1		4	K2		1
B		2	K3		1
B1		2	S		2
C		2	18A		4
J		4	18B		2
J1		2	19A		4
K		1	19B		2
K1		1			



PART LIST(BOX C)

Label No.	PART	Qty	Label No.	PART	Qty
A2		2	H1		2
C1		2	H2		2
C2		2	I		2
E1		8	I1		2





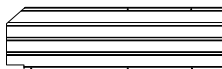
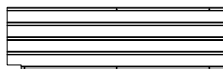

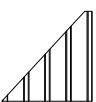
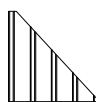
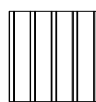

PART LIST

F		8	L2		2
F1		4	L1		6
F2		3	L2		6
G		4	L3		4
G1		4	L4		4
G2		4	X1		6
H		2			





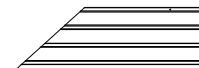
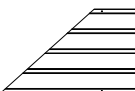









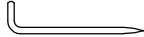





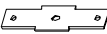
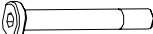



PART LIST(BOX D)

⑧		⑨		⑭	
4PCS		4PCS		4PCS	
⑮		⑯			
4PCS		4PCS			



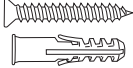









PART LIST(BOX E)

①		②		③	
4PCS		4PCS		12PCS	
④		⑤		⑥	
4PCS		4PCS		4PCS	
⑦		⑩		⑪	
4PCS		4PCS		4PCS	
⑫		⑬			
4PCS		4PCS			

Srew Set (BOX B)

Label No.	PART	Qty	Label No.	PART	Qty	Label No.	PART	Qty
A3		2	R		156	Z1		2
A4		2	T		10	Z2		1
L		4	U		88	Z3		96
M		8	V	 M6*15	314	Z4		24
N		8	V1	 M6*130	8	Z5		1
N1		4	V3	 M6*55	16	Z6	 M6*20	6
O		8	W	 M6*25	56	Z7		8
P		4	X	 M6*48	32	20		24
Q		6	Y		32			
Q1		4	Z		8			

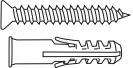
Extra(Srew Set)

Label No.	PART	Qty	Label No.	PART	Qty	Label No.	PART	Qty
R		10	W	 M6*25	3	Z3		7
U		5	X	 M6*48	2	Z4		1
V	 M6*15	15	Y		1	Z6	 M6*20	1
V1	 M6*130	1	Z		1	20		1
V3	 M6*55	1						

Installation steps

STEP 1

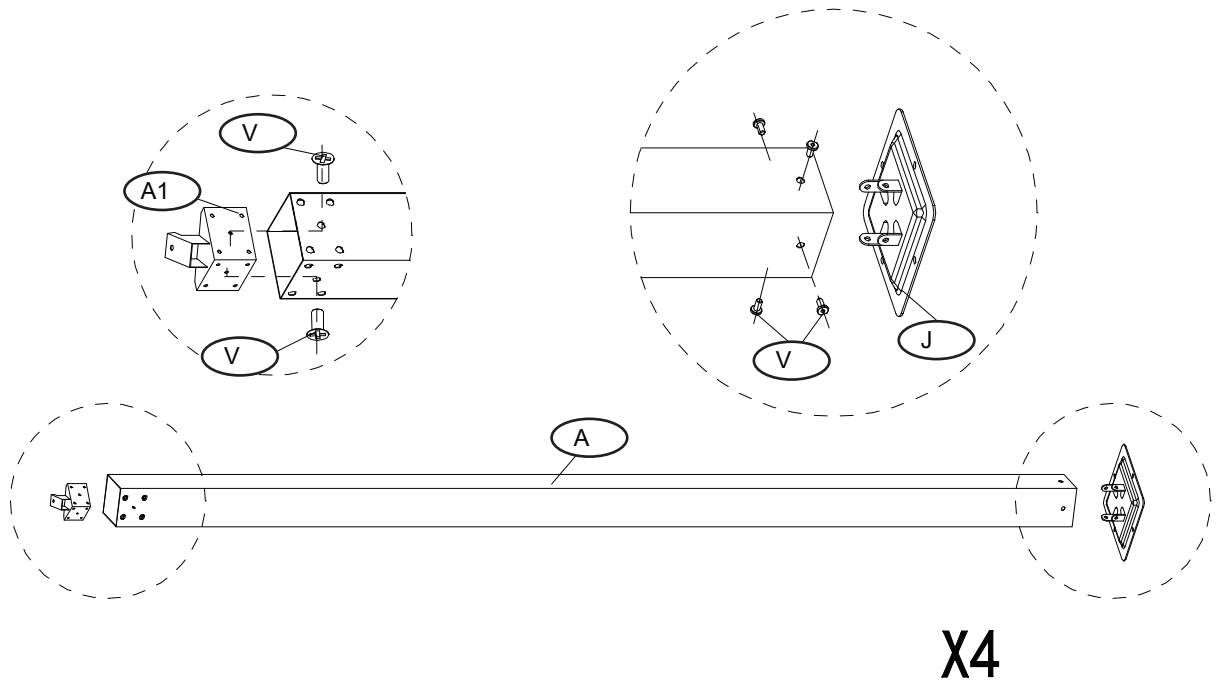

M6x15
Vx24PCS

STEP 2

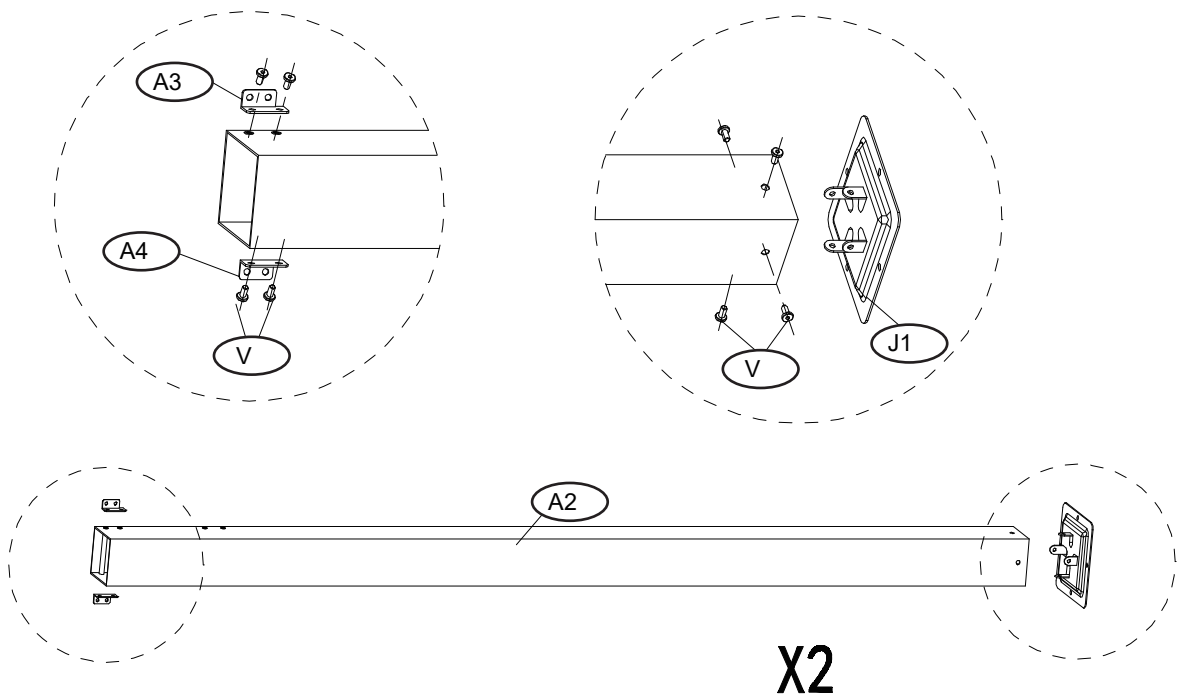



M6x15
Vx16PCS

Installation steps

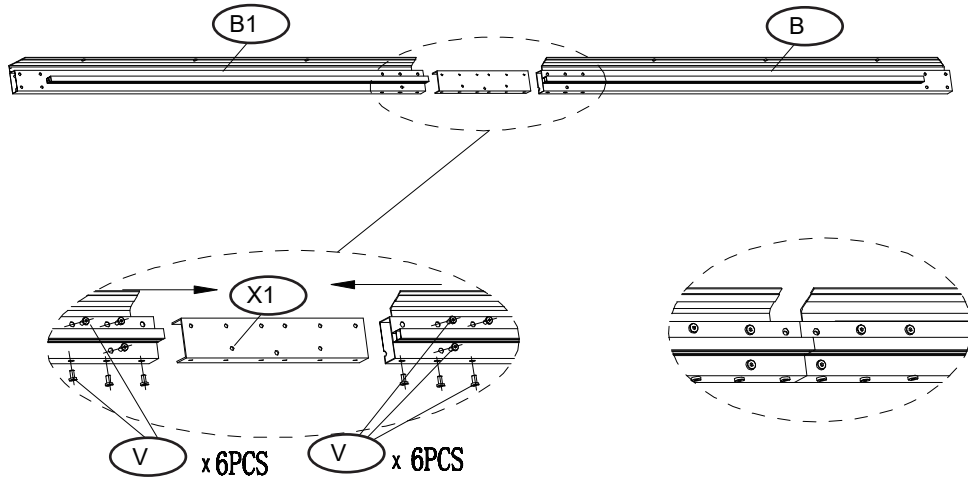
STEP 3



X2

M6x15
Vx24PCS

STEP 4

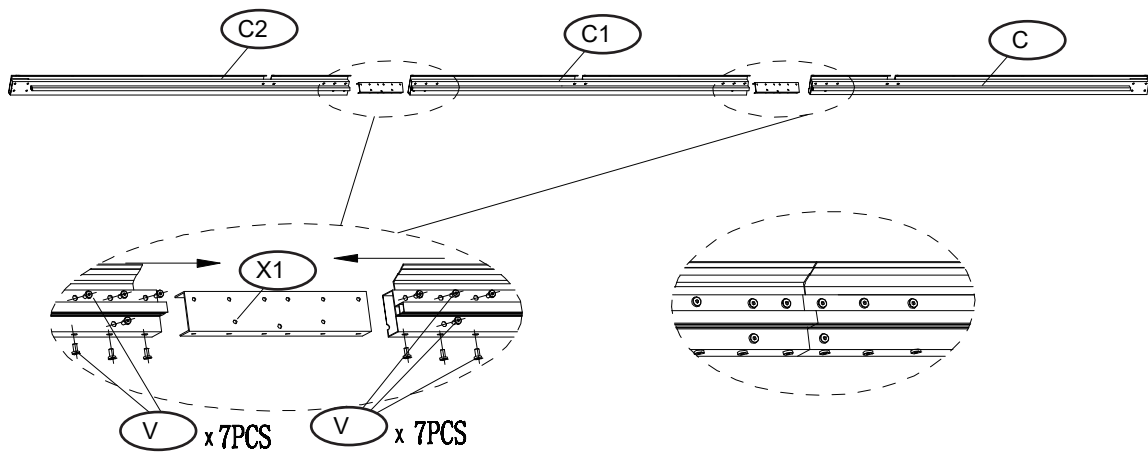



X2

M6x15
Vx56PCS

Installation steps

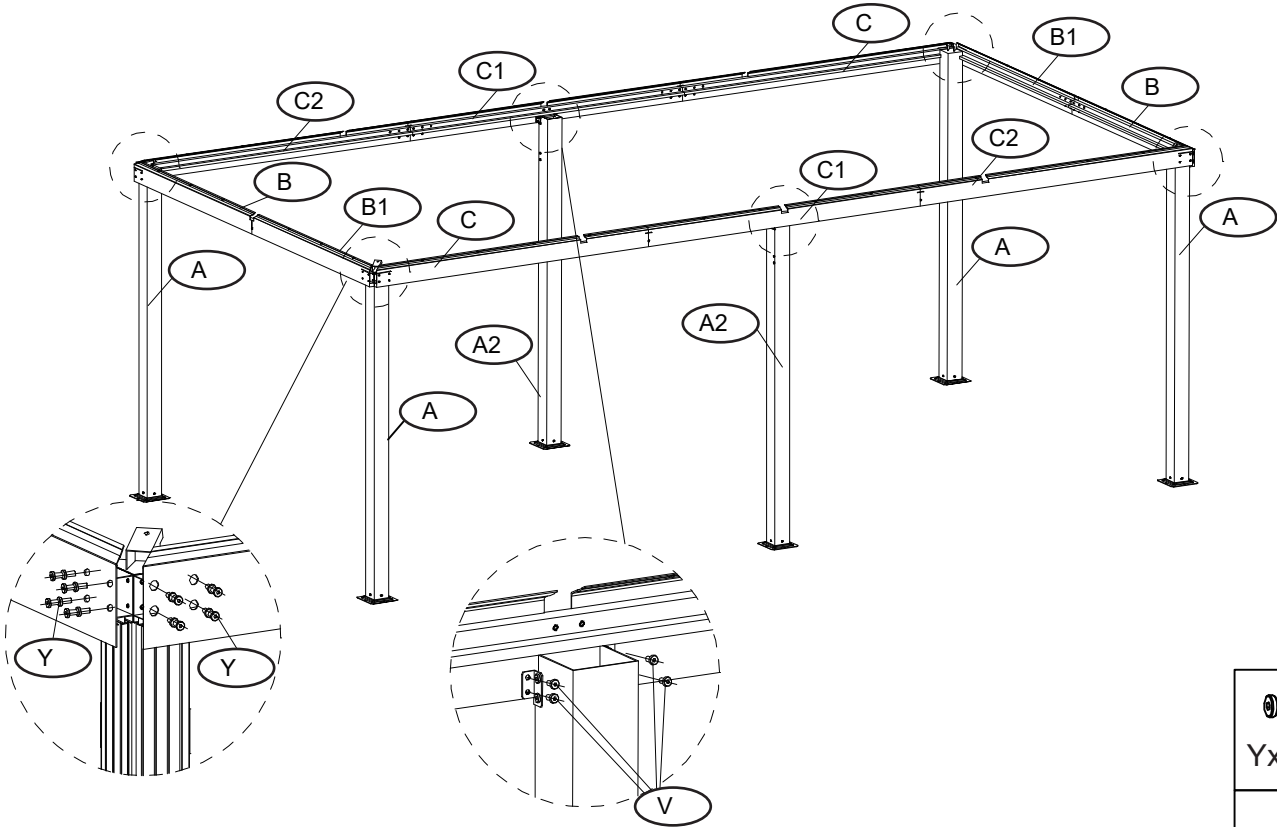

STEP 5

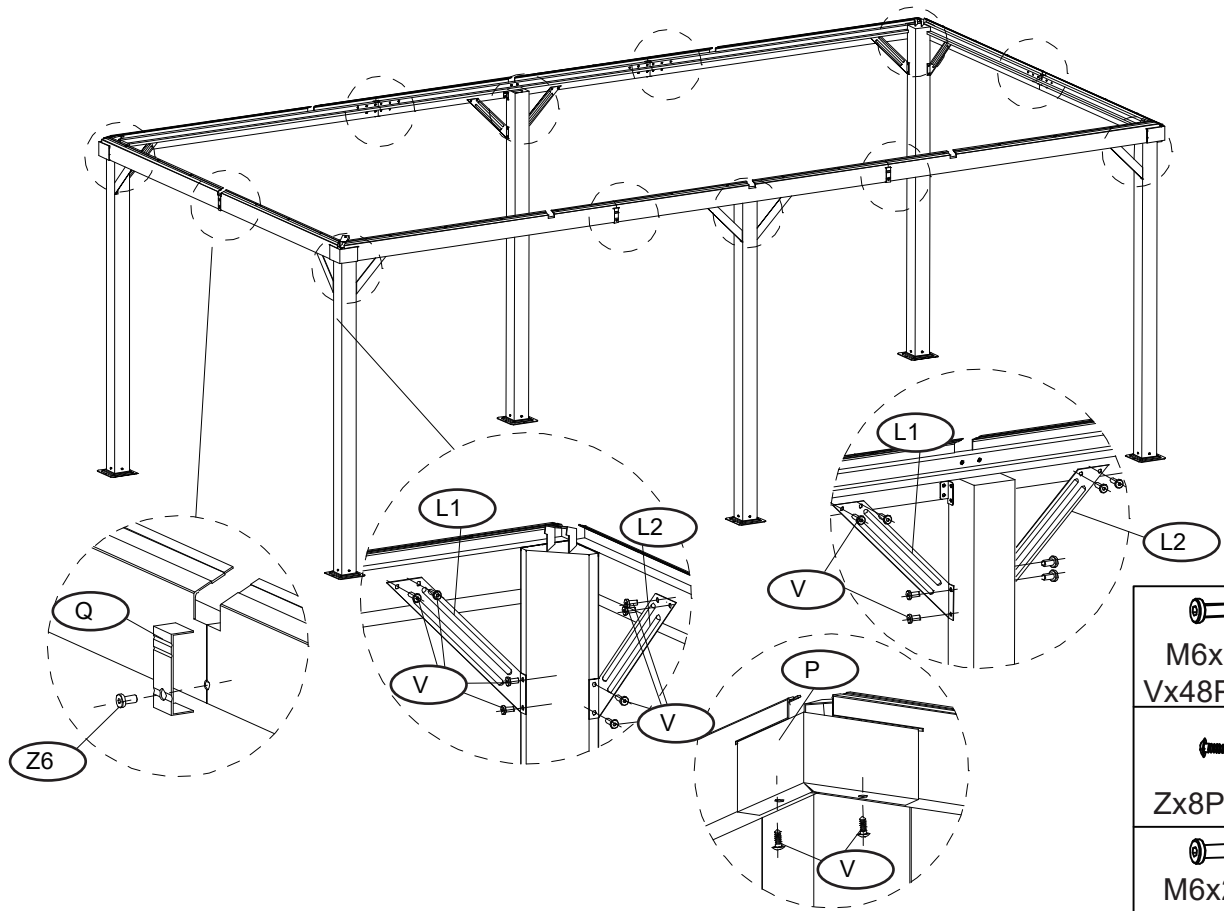

- 
 Yx32PCS
- 
 M6x15
 Vx8PCS

STEP 6





- 
 M6x15
 Vx48PCS
- 
 Zx8PCS
- 
 M6x20
 Z6x6PCS

Installation steps

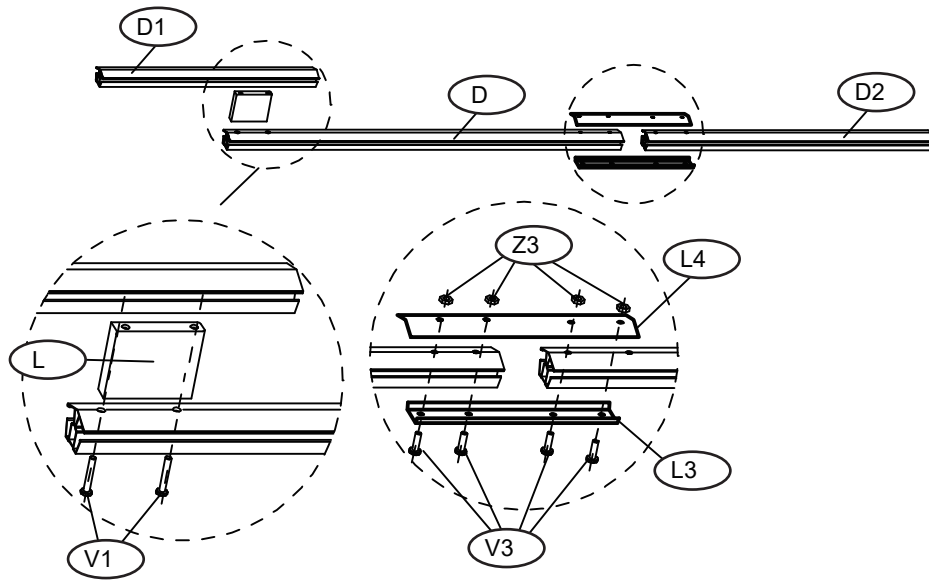
STEP 7



	M6x130 V1x8PCS
	M6x55 V3x16PCS
	Z3x16PCS

STEP 8

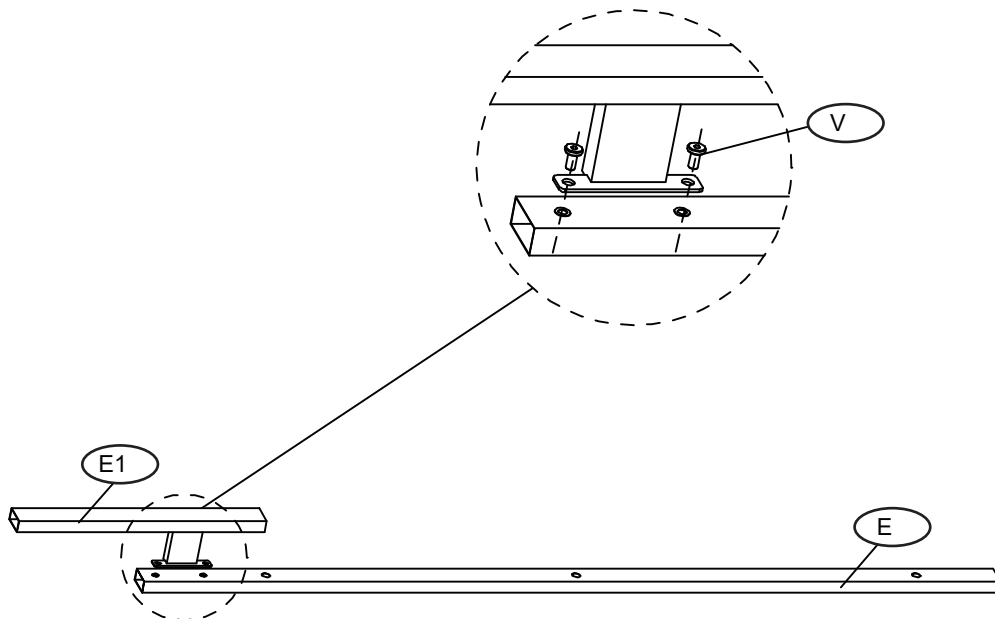



	M6x15 Vx16PCS
---	------------------

Installation steps

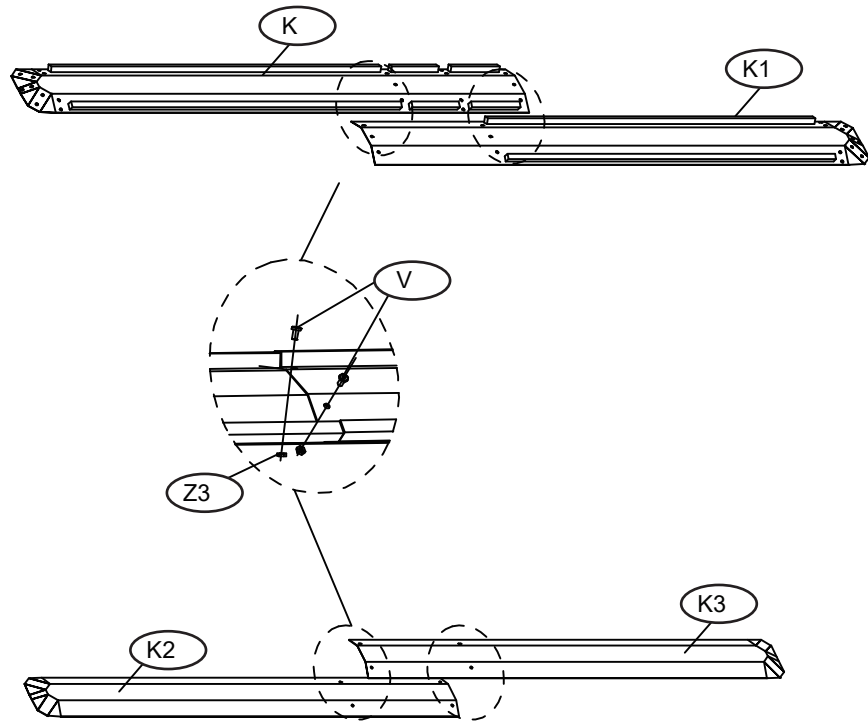
STEP 9



-  M6x15
Vx8PCS
-  Z3x8PCS

STEP 10

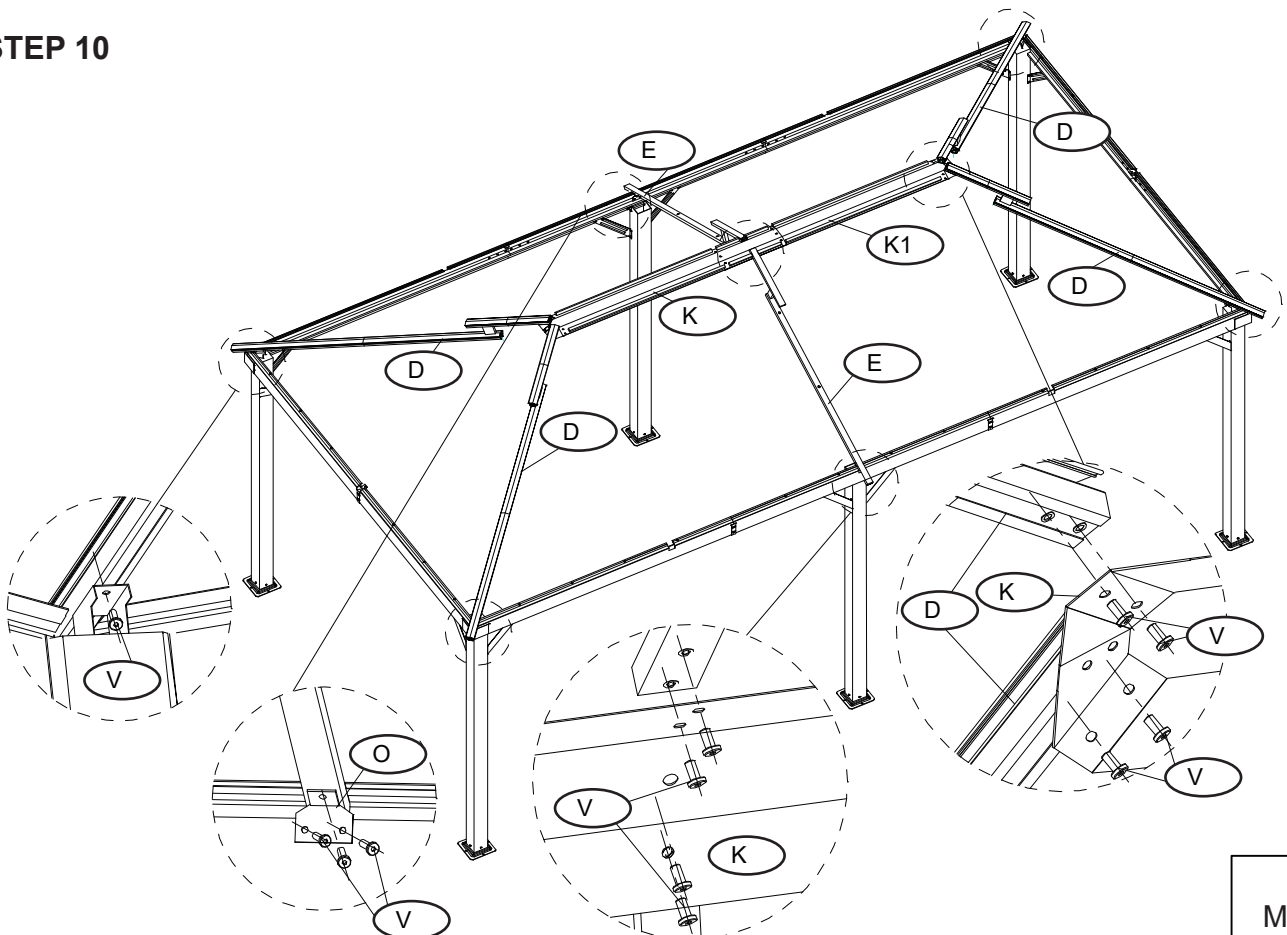

-  M6x15
Vx22PCS

Installation steps

STEP 11

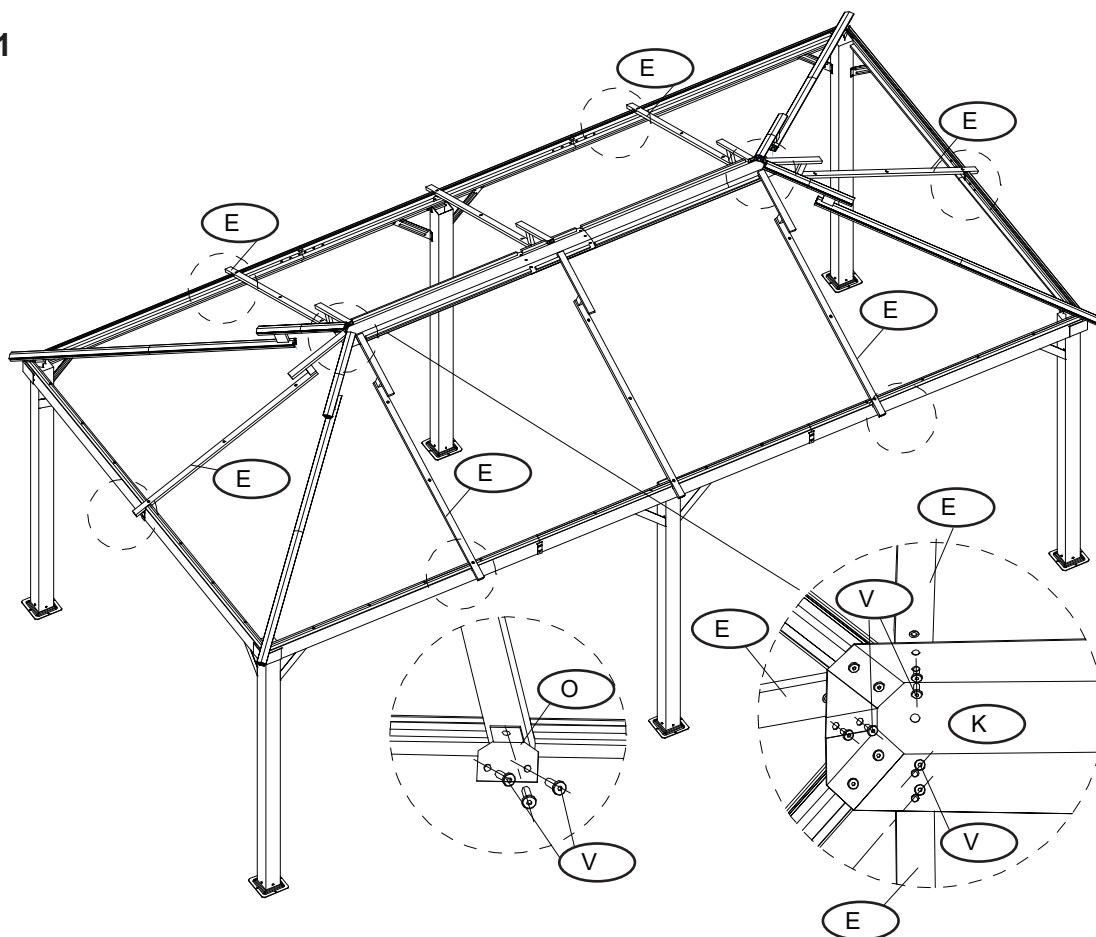

M6x15
Vx30PCS

STEP 12

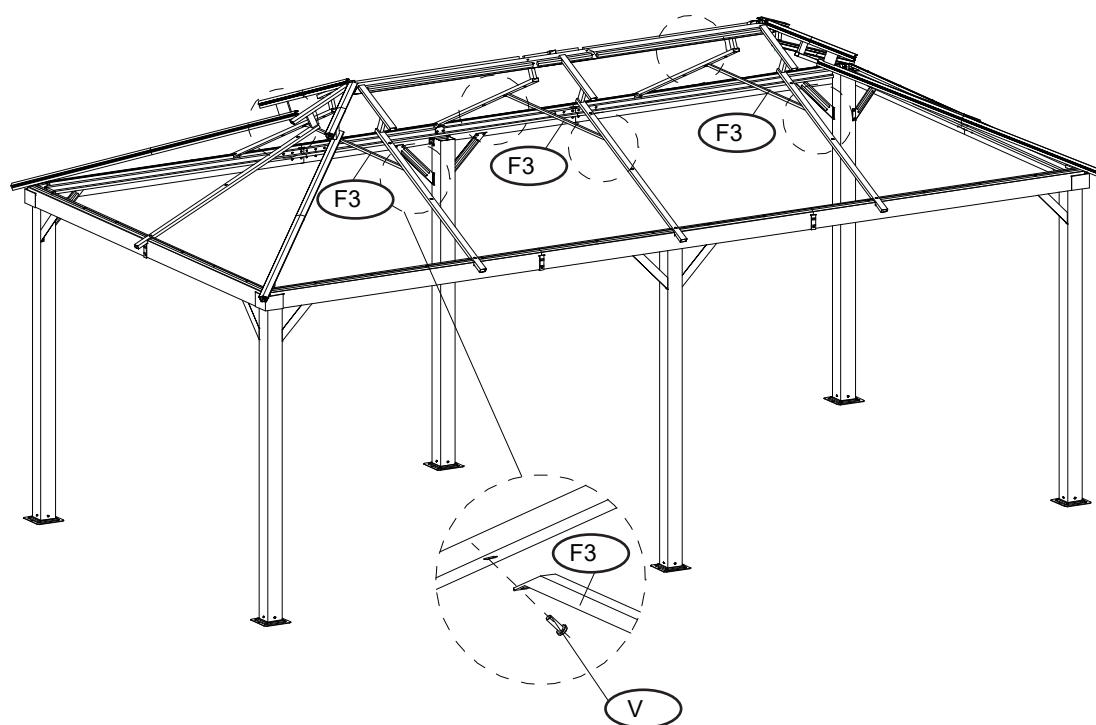

M6x15
Vx6PCS

Installation steps

STEP 13

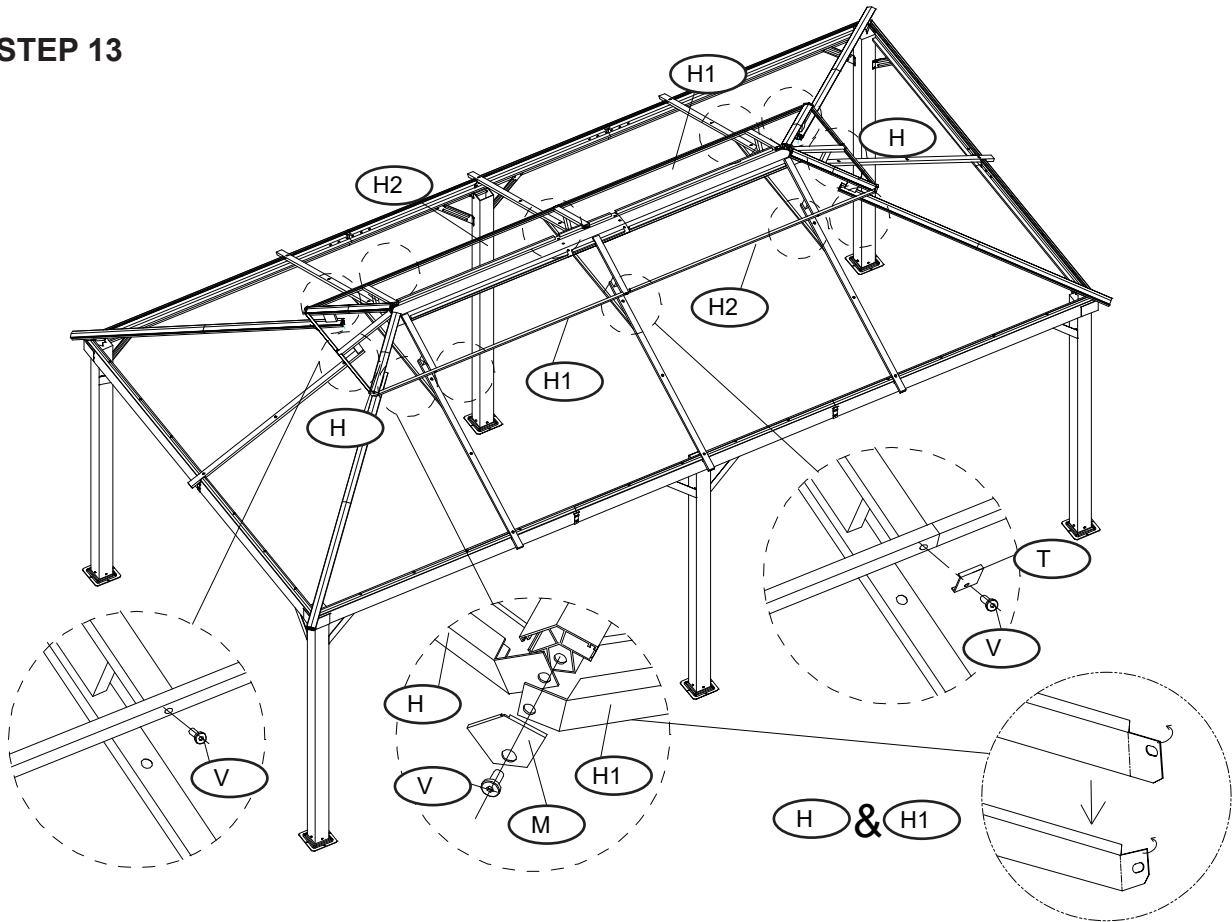

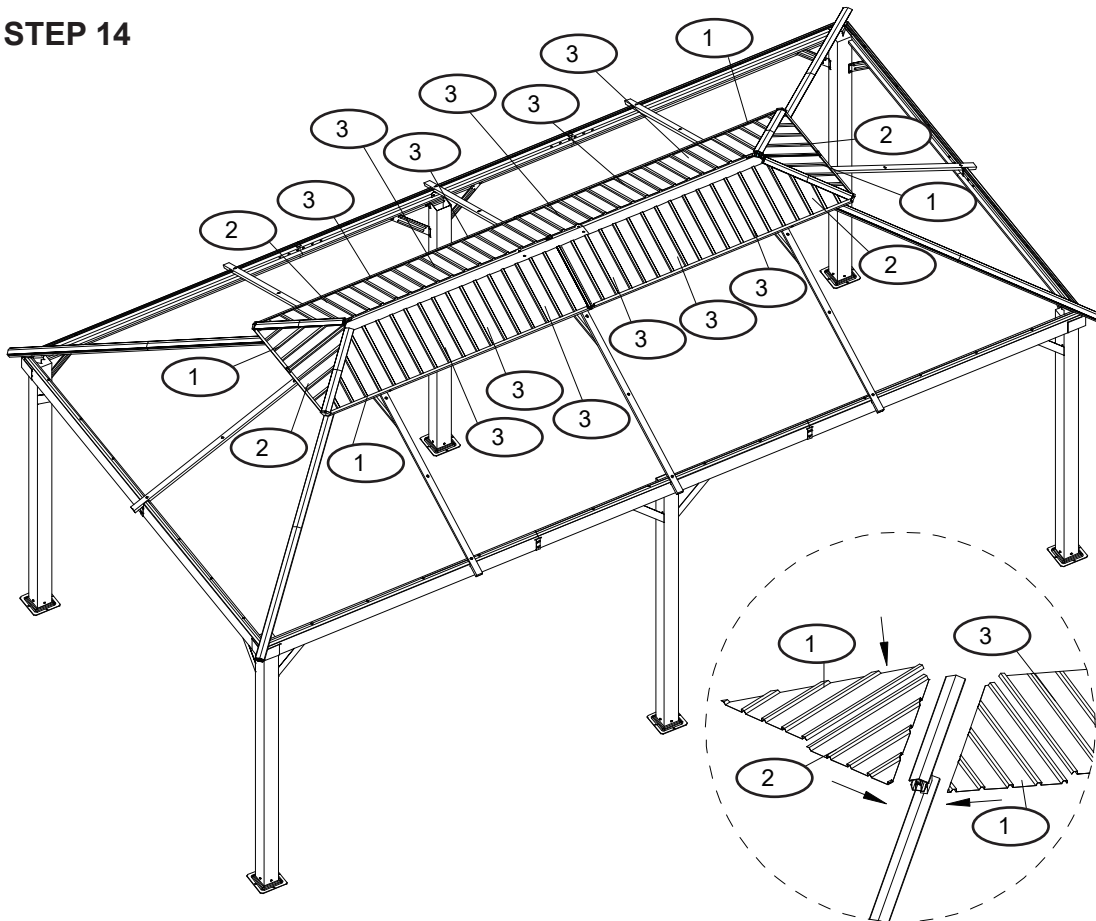

M6x15
Vx12PCS

STEP 14

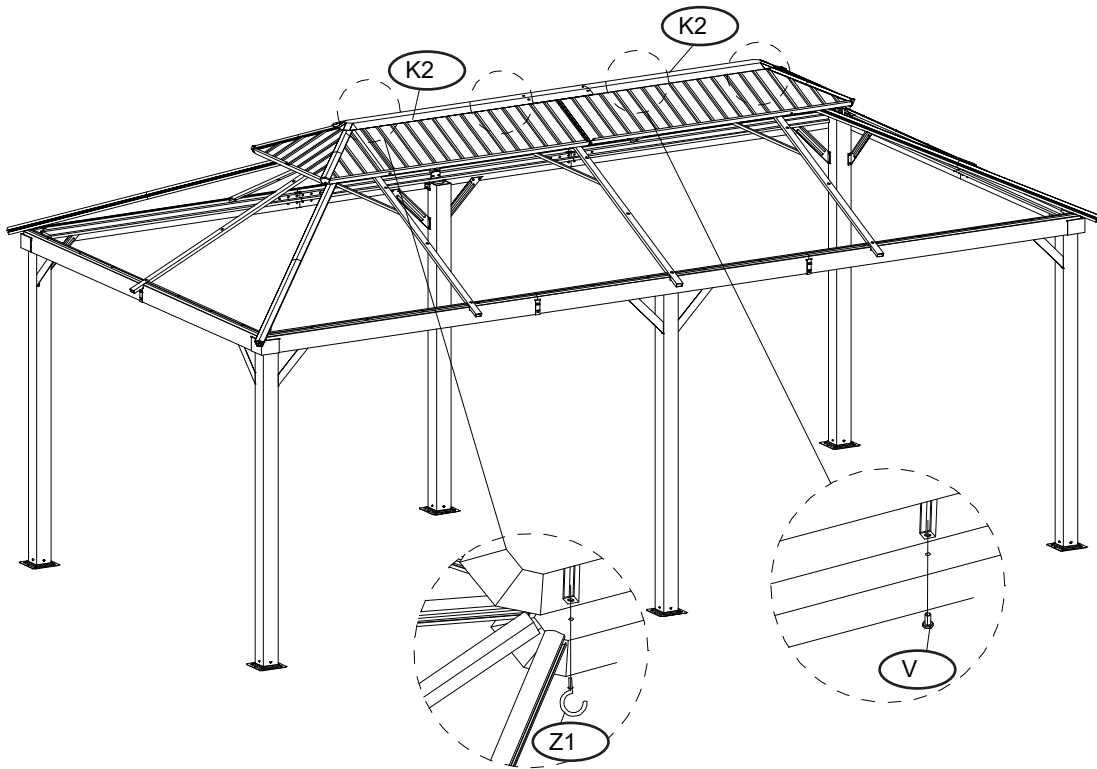

Installation steps

STEP 15



Z1x2PCS



M6x15
Vx2PCS

STEP 16

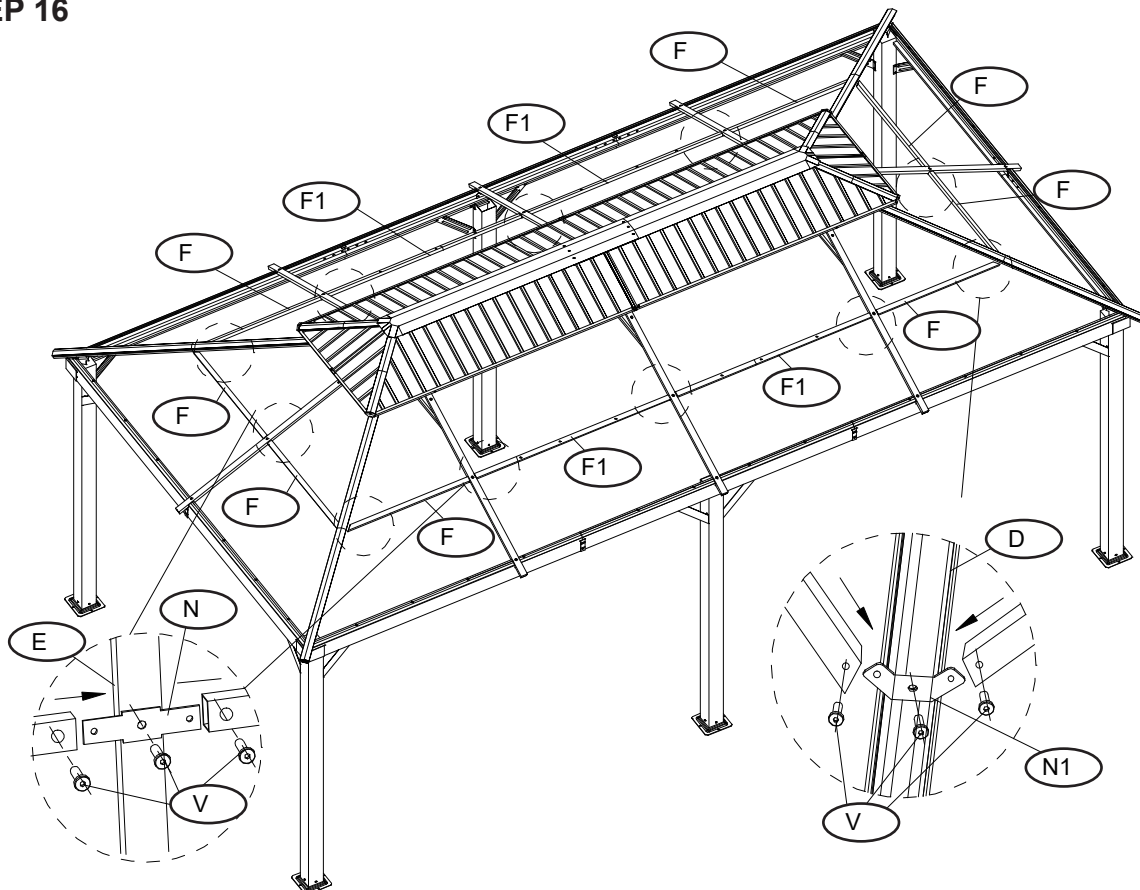

M6x15
Vx36PCS

Installation steps



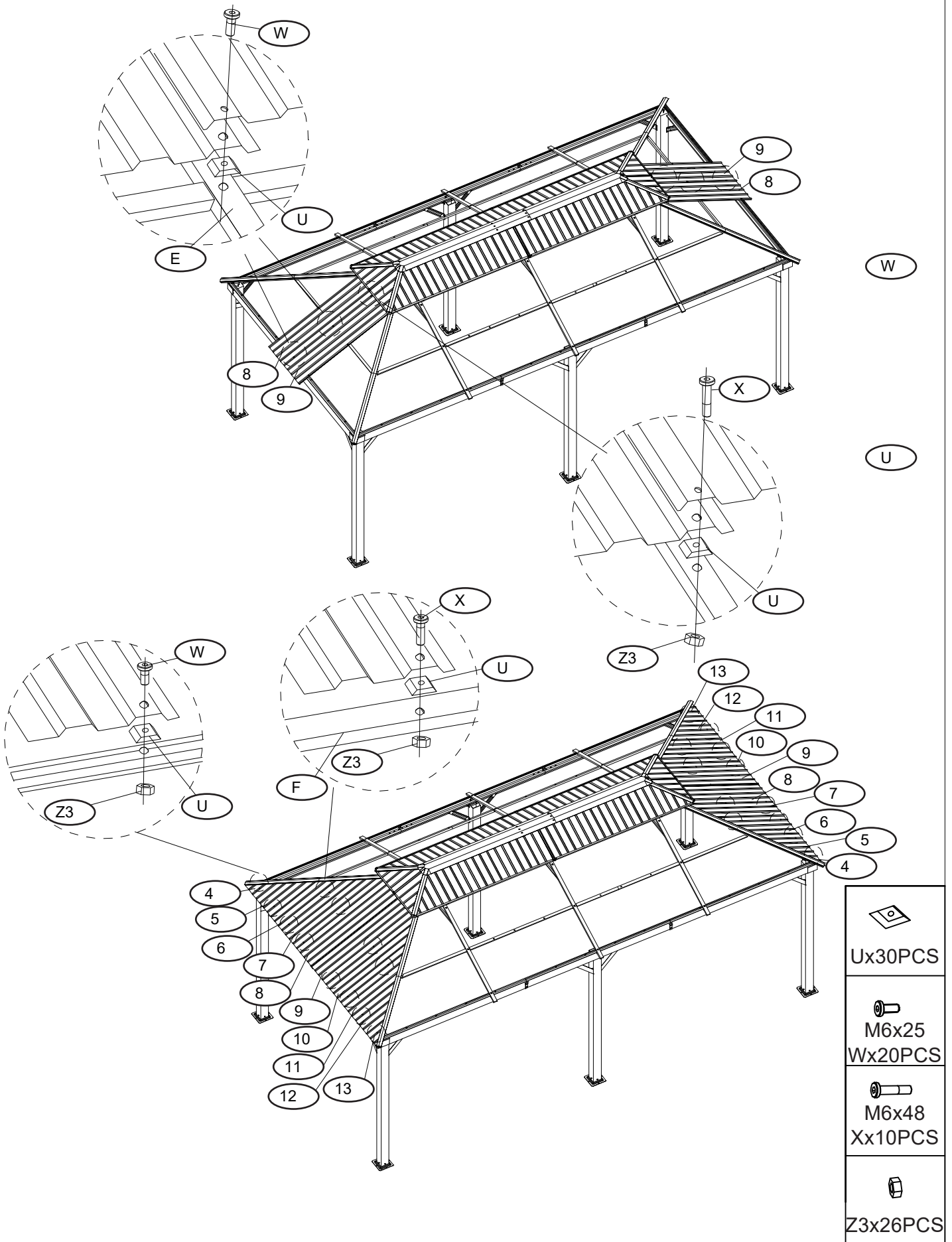

STEP 17

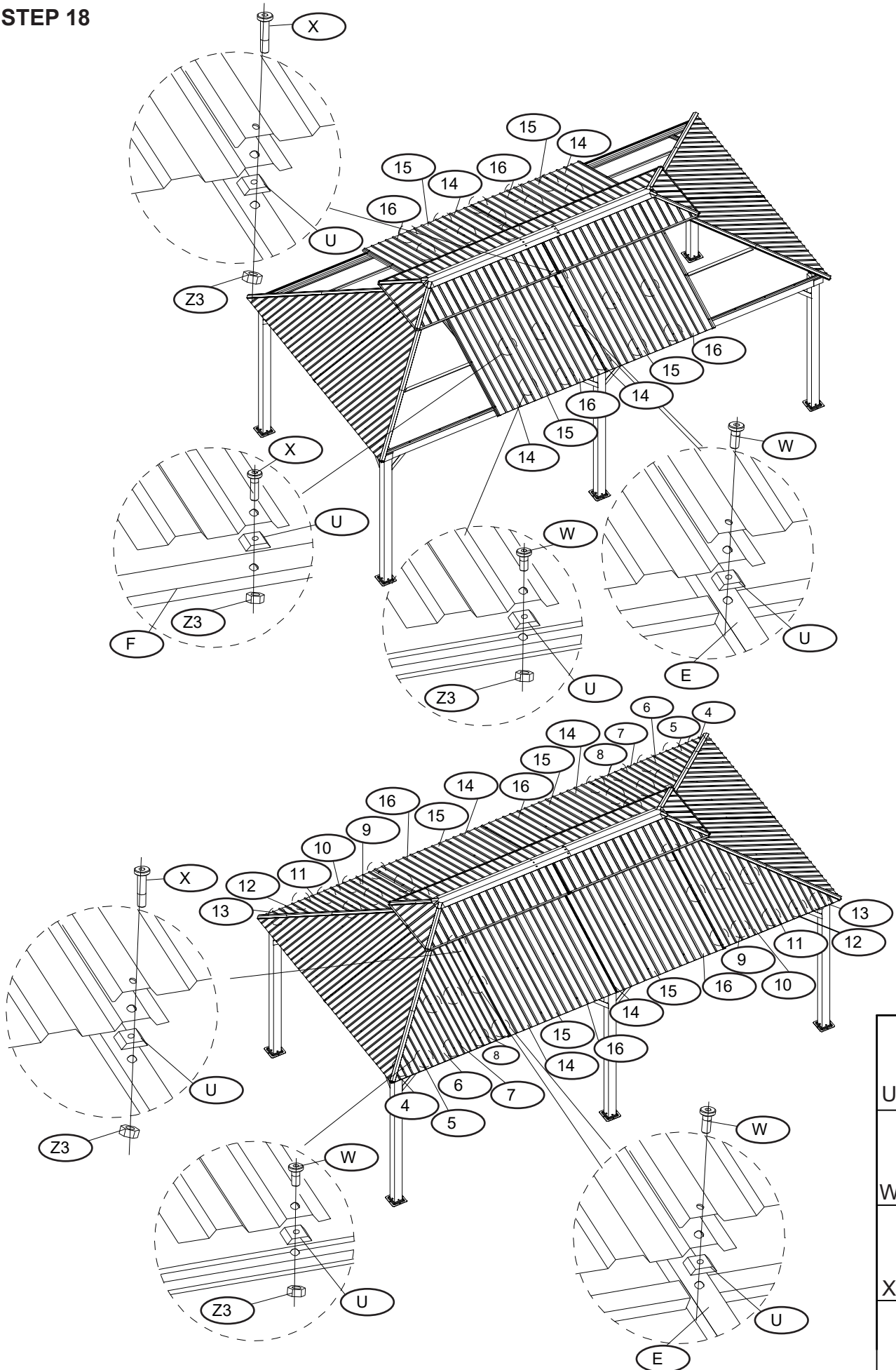

Installation steps

STEP 18



	Ux58PCS
	M6x25 Wx36PCS
	M6x48 Xx22PCS
	Z3x46PCS

Installation steps

STEP 20

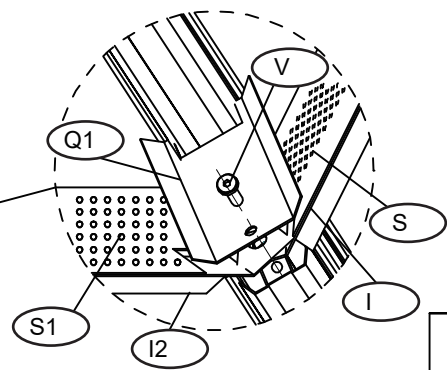
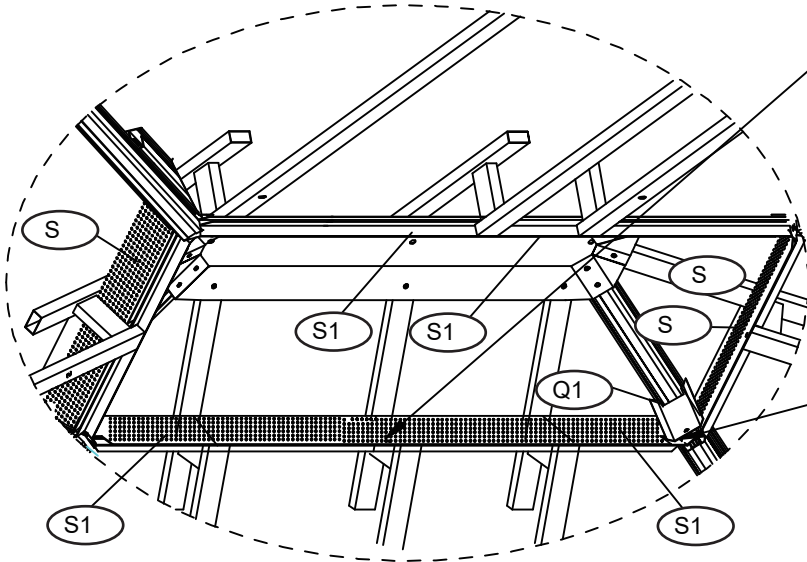
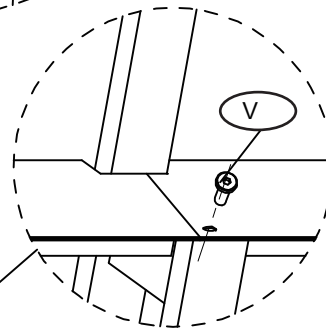
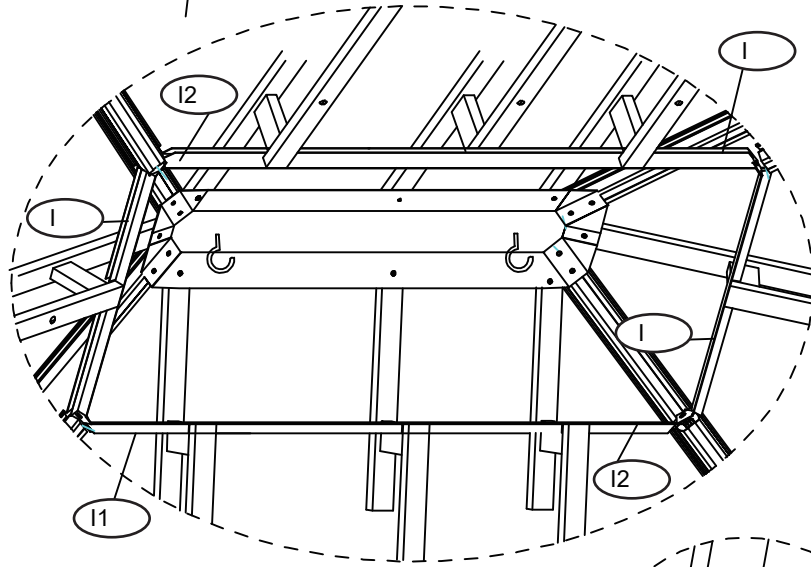
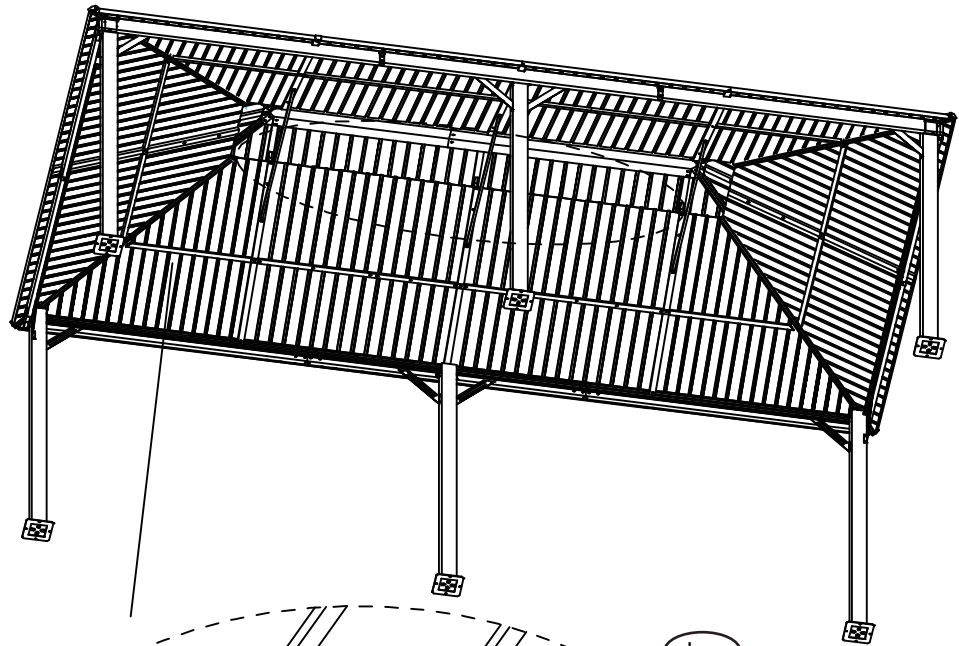



M6x15
Vx12PCS

Installation steps

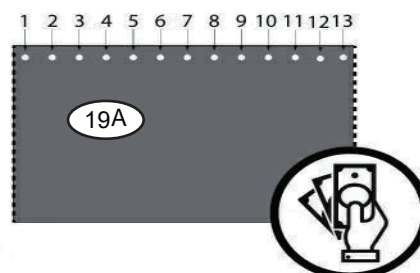
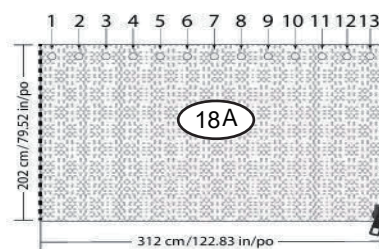
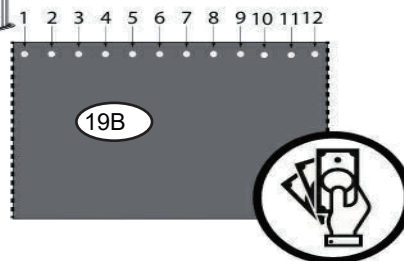
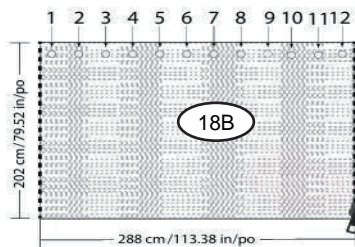
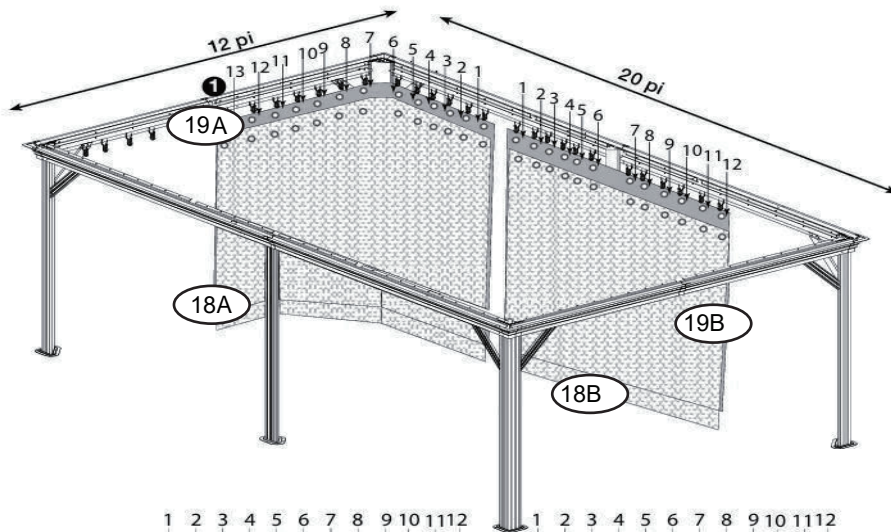
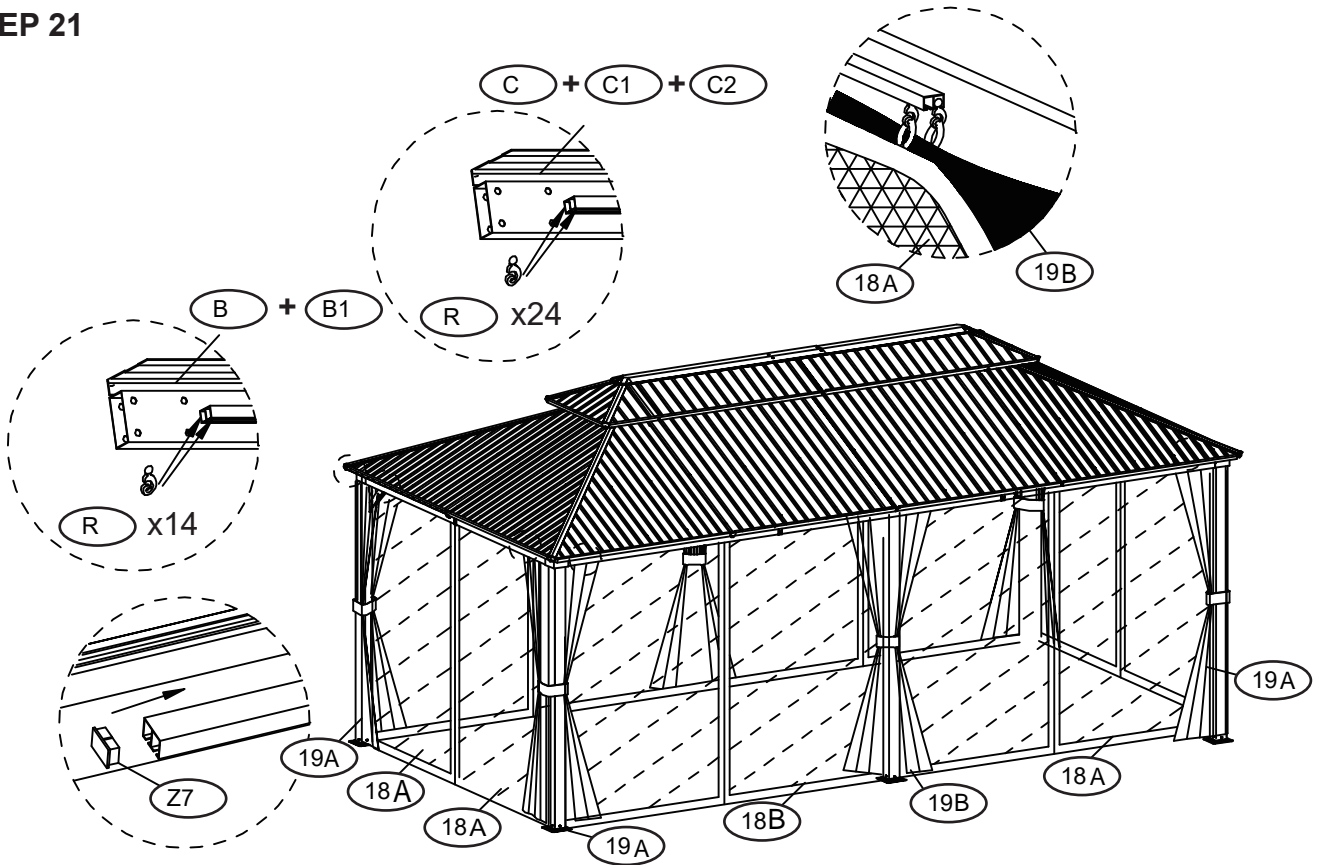
STEP 21



	Rx152PCS
	Z7x8PCS

STEP 22

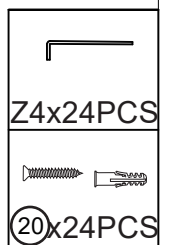
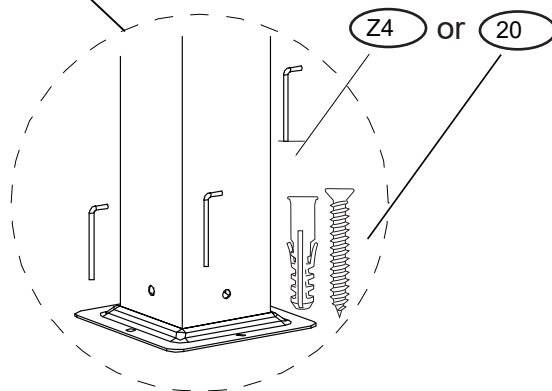
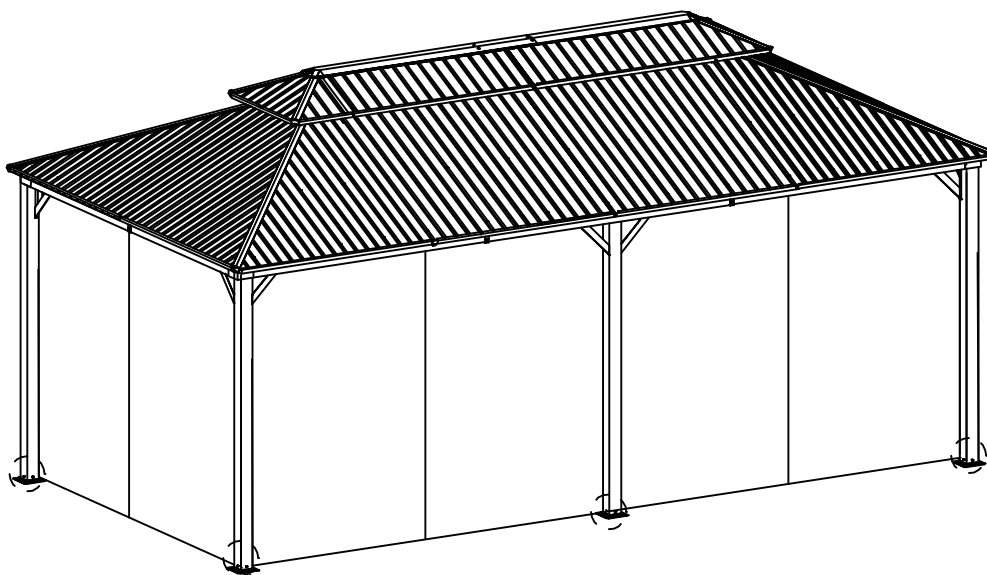

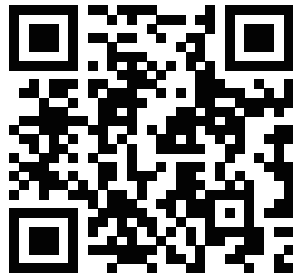

www.alaulm.com

Make Your Life Much Better.