

# Installation & Assembly

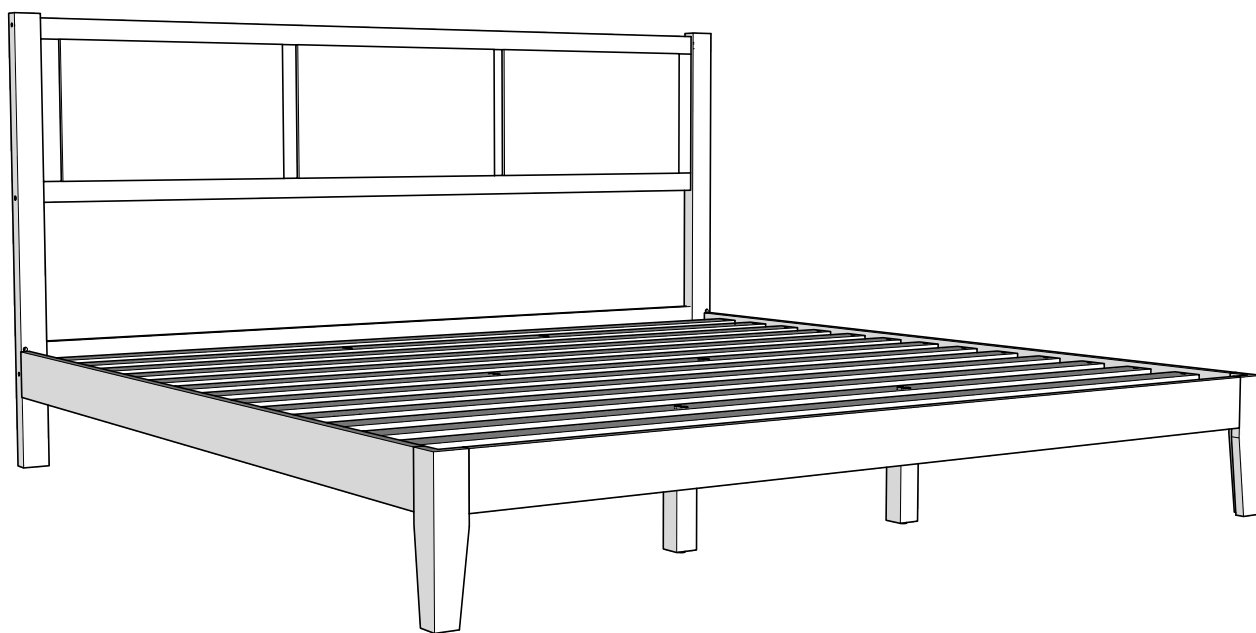



# IMPORTANT INFORMATION

Seller and Manufacturer disclaim all and any liability for property damage, personal injury, or loss, direct, indirect, or incidental, resulting from the incorrect assembly, inadequate maintenance, improper use, or neglect of this product.



## NOTICE

- Keep these assembly instructions for future reference.
- Do not use this product if there are missing, damaged, or broken parts until repairs are made and/or factory replacement parts are installed.
- Check all packing material carefully for small hardware that may have become loose inside the carton during shipment.
- Identify and count all hardware and parts to compare with parts and hardware list.
- Follow assembly instructions closely. Improper assembly can result in personal or property damage.
- Secure all bolts before use.
- Every 90 days check all bolts are secured.
- Some parts may have a sharp corner or edge and maybe heavy.
- Do not use or store this product near open flames or around flammable chemicals.
- When placing contents on non-carpeted flooring, it's recommended to use floor protection such as an area rug or furniture pads. These are not included with the purchase.

## REPLACEMENT PART OR HARDWARE REQUEST:

Request a replacement by logging into the marketplace account in which the purchase was made and sending a message to the seller. To assist in expediting the request attach applicable images relevant to the request and/or part number and quantity.

## ADDITIONAL TOOL REQUIRED:

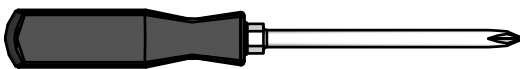



**#2 Philips Screwdriver  
( Not Provided)**

# BED PARTS

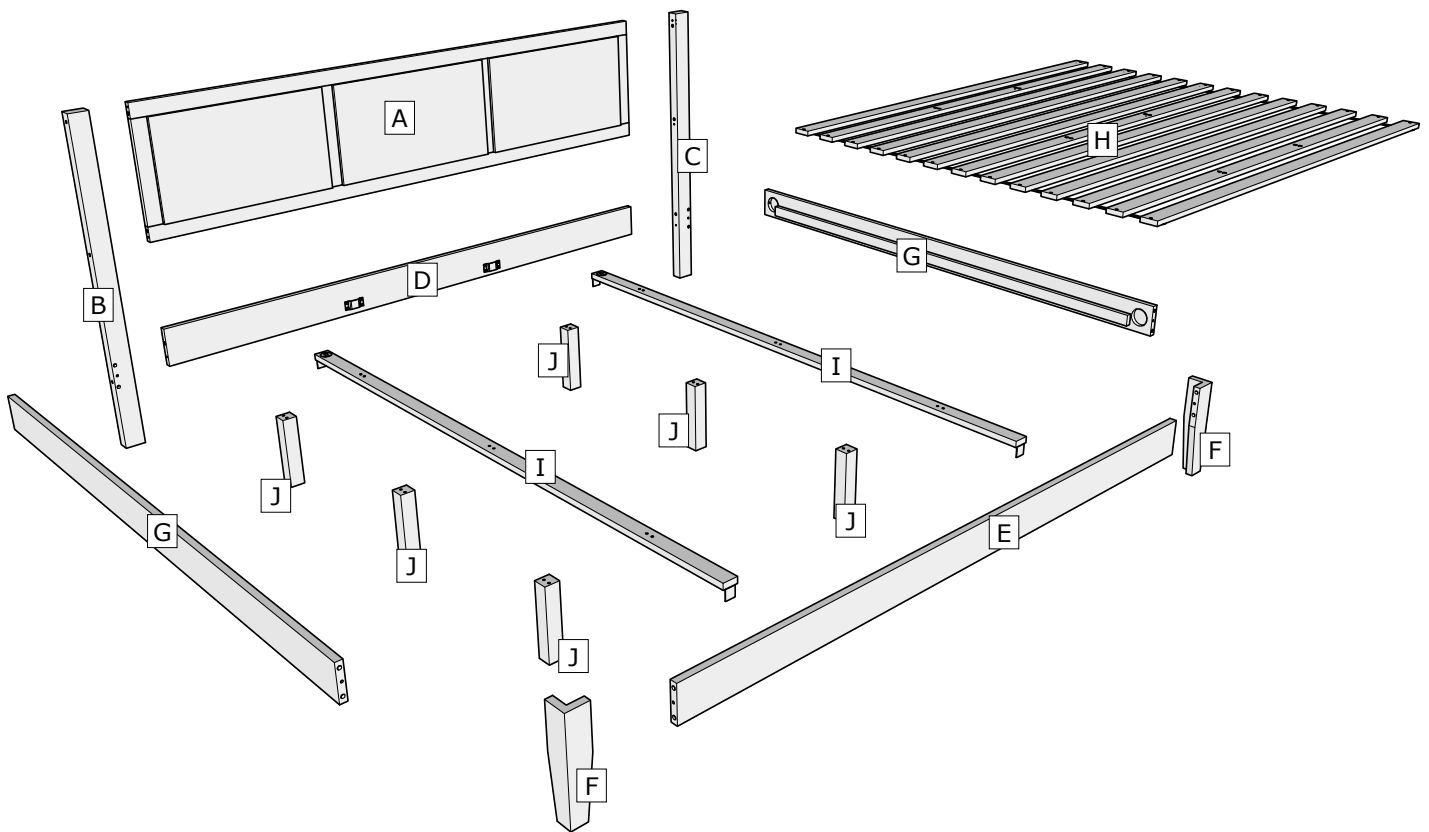

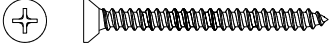
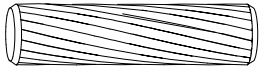
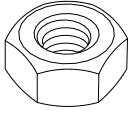
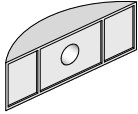
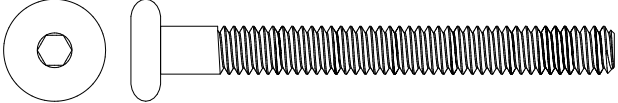
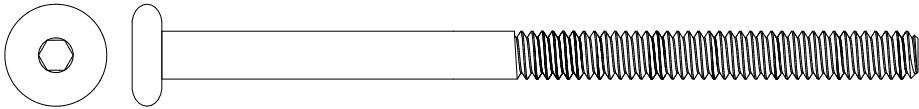
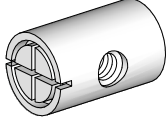
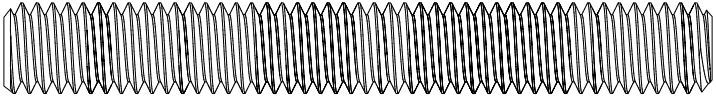
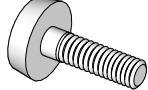

- A..... Headboard ..... x 1
- B..... Headboard Post Left ..... x 1
- C..... Headboard Post Right..... x 1
- D..... Headboard Rail..... x 1
- E..... Footboard ..... x 1
- F..... Footboard Leg ..... x 2
- G..... Side Rail ..... x 2
- H..... Bed Slat ..... x 13
- I..... Slat Support..... x 2
- J..... Support Leg ..... x 6

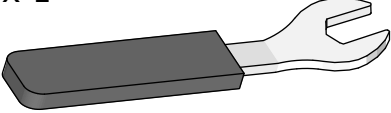

# HARDWARE

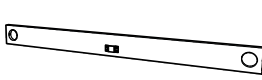
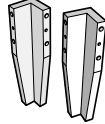
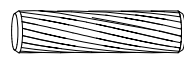
<p><b>K</b> Screw x 26</p>  <p>M4 x 32mm</p>	<p><b>L</b> Dowel x 18</p>  <p>M10 x 40mm</p>	<p><b>M</b> Hex Nut x 6</p>  <p>M8</p>
<p><b>N</b> Half Moon Washer x 6</p>  <p>M8 x 30mm</p>	<p><b>O</b> Bolt x 12</p>  <p>M6 x 60mm</p>	
<p><b>P</b> Bolt x 6</p>  <p>M6 x 100mm</p>		<p><b>Q</b> Barrel Nut x 6</p> 
<p><b>R</b> Threaded Rod x 6</p>  <p>M8 x 65mm</p>		<p><b>S</b> Adjustable Feet x 6</p> 
<p><b>T</b> Hex Key Wrench x 1</p>  <p>M4</p>	<p><b>U</b> Open End Wrench x 1</p>  <p>M8</p>	

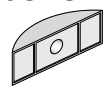

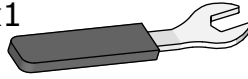

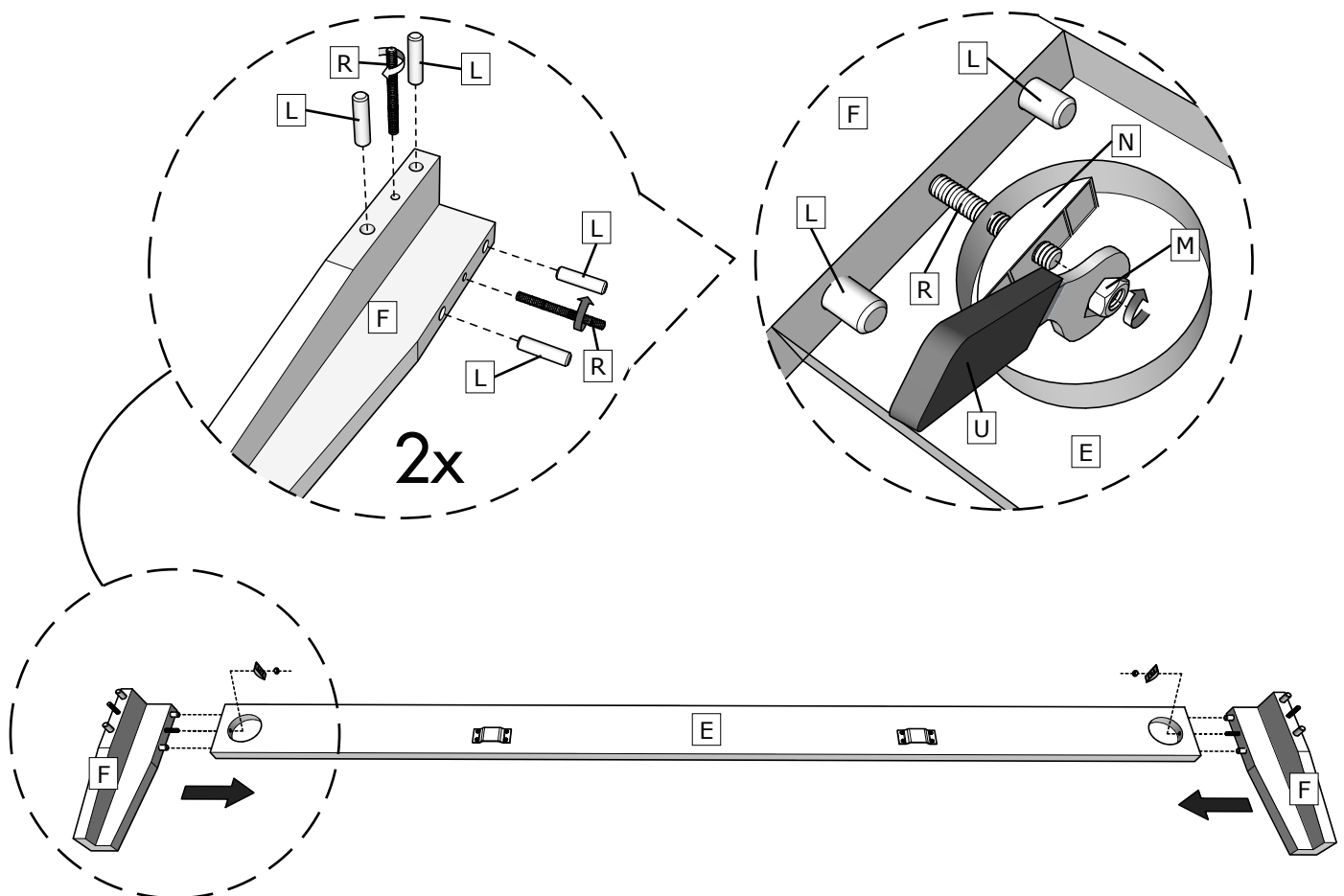
# BED ASSEMBLY STEP 1

<b>E</b> Footboard x1 	<b>F</b> Footboard Leg x2 	<b>L</b> Dowel x8  M10 x 40mm	<b>M</b> Hex Nut x2  M8
<b>N</b> Half Moon Washer x2  M8 x 30mm	<b>R</b> Threaded Rod x4  M8 x 65mm	<b>U</b> Open End Wrench x1  M8	

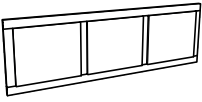
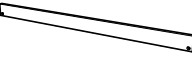

Insert **L** and **R** into **F**.  
 Attach **F** to **E** with **M** and **N** using an Open End Wrench **U**.

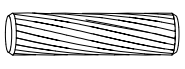
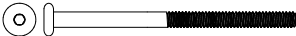
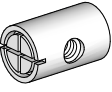
# BED ASSEMBLY STEP 2

<b>A</b> Headboard x1 	<b>D</b> Headboard Rail x1 	<b>B</b> Headboard Post Left x1 	<b>C</b> Headboard Post Right x1 
<b>L</b> Dowel x6  M10 x 40mm	<b>P</b> Bolt x6  M6 x 100mm	<b>Q</b> Barrel Nut x6 	<b>T</b> Hex Key Wrench x1  M4
Philips Screwdriver  Not provided			

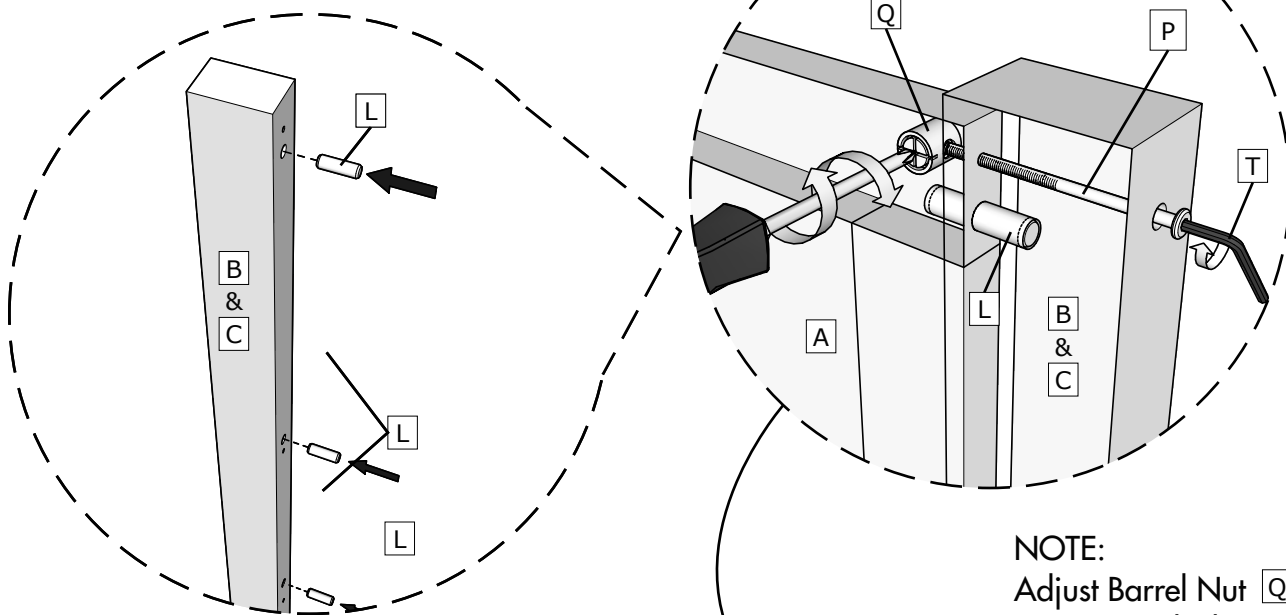

**NOTE:**  
 Adjust Barrel Nut **Q** clockwise or counter clockwise to align the Barrel Nut hole **Q** to Bolt **P**.

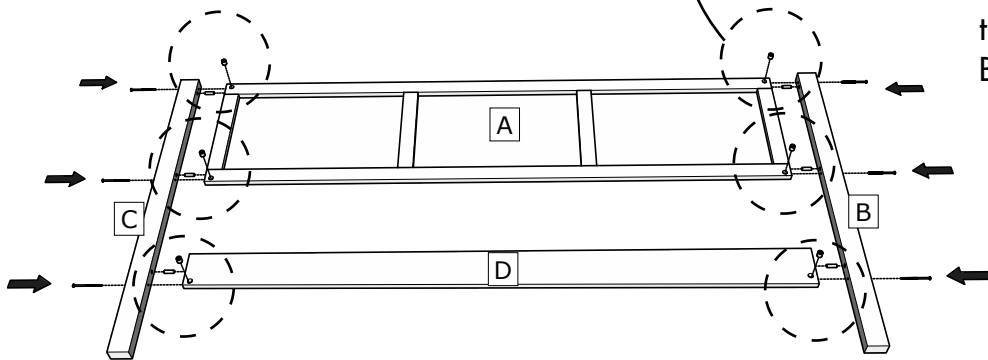

Insert **K** to **B** and **C** as shown.  
 Attach **B** and **C** to **A** and **D** with **P** and **Q** using a Philips Screwdriver and a Hex Key Wrench **T**.

# BED ASSEMBLY STEP 3

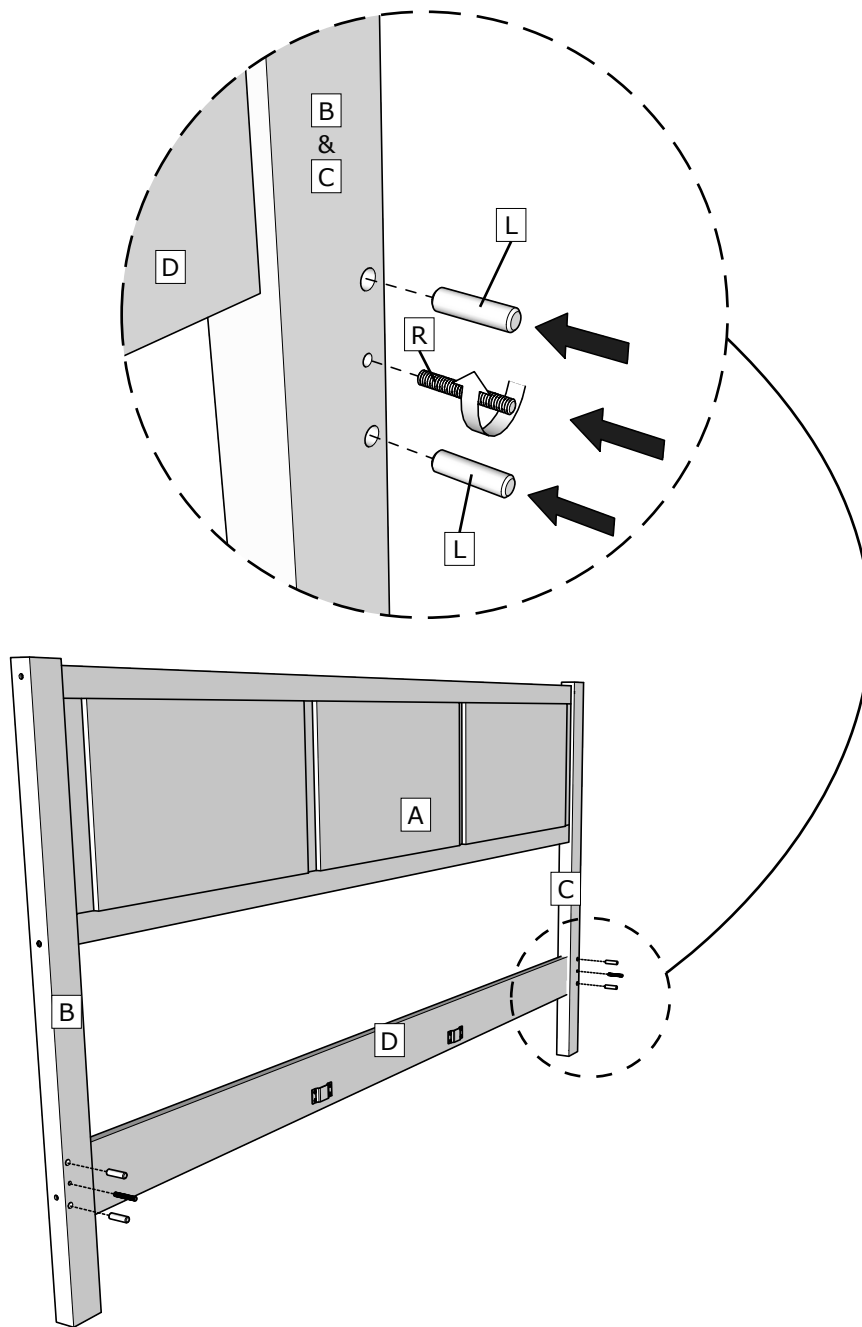
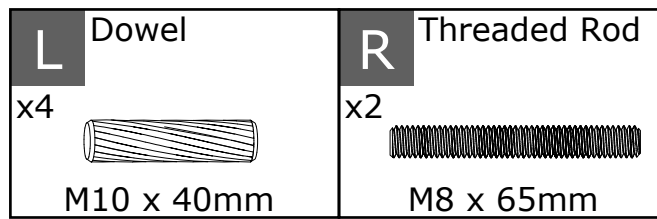

Insert **L** and **R** into **B** and **C**.

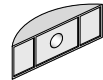
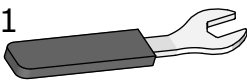

# BED ASSEMBLY STEP 4

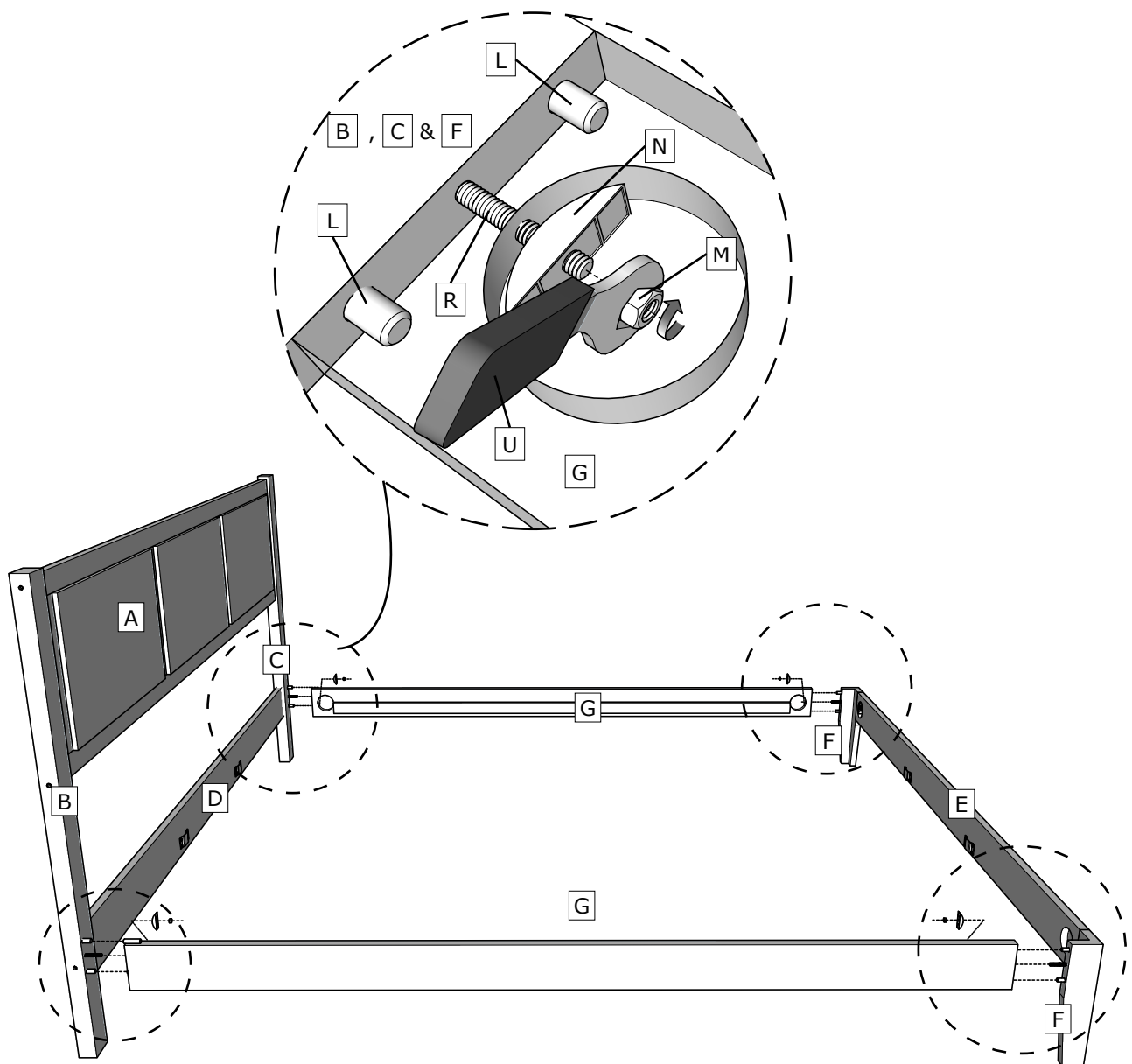
<b>M</b> Hex Nut x4 M8 	<b>N</b> Half Moon Washer x4 M8 x 30mm 	<b>U</b> Open End Wrench x1 M8 
---	---	--

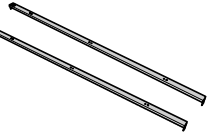
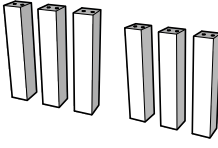
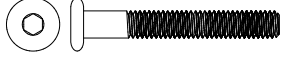
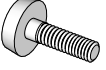

Attached **G** to Assembled Headboard and Assembled Footboard with **M** and **N** using an Open End Wrench **U**.

# BED ASSEMBLY STEP 5

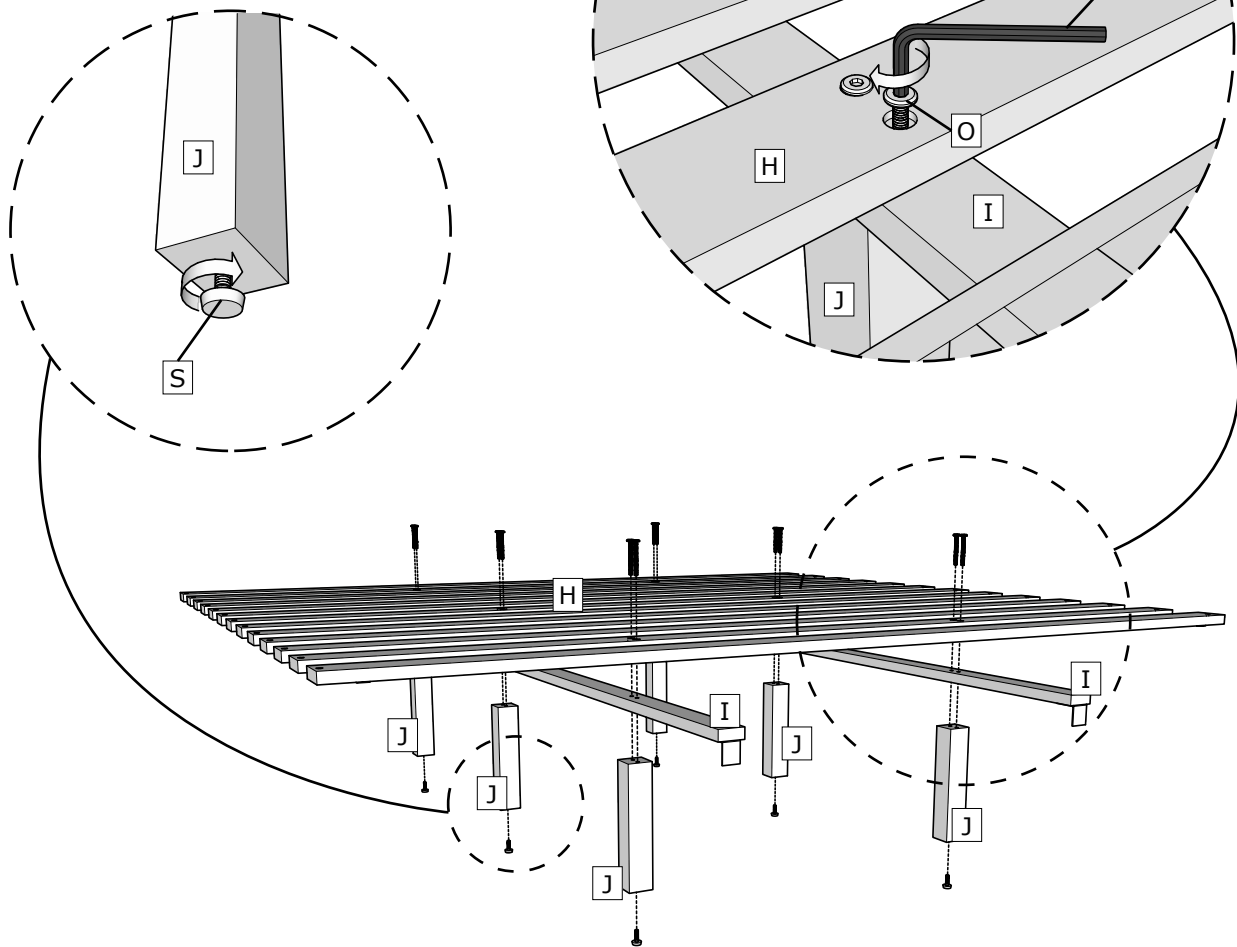

<b>H</b> Bed Slat x13 	<b>I</b> Slat Support x2 	<b>J</b> Support Leg x6 	<b>O</b> Bolt x12 M6 x 60mm 
<b>S</b> Adjustable Feet 6 	<b>T</b> Hex Key Wrench x1 M4 		

Note:  
See Bed Assembly Step 7 to  
properly adjust part **S**



Insert **S** into **J**. Attach **H** and **J** to **I** with **O** using a Hex Key Wrench **T** as shown.

# BED ASSEMBLY STEP 6

<b>K</b> Screw x26  M4 x 32mm	Philips Screwdriver  Not provided
---	---

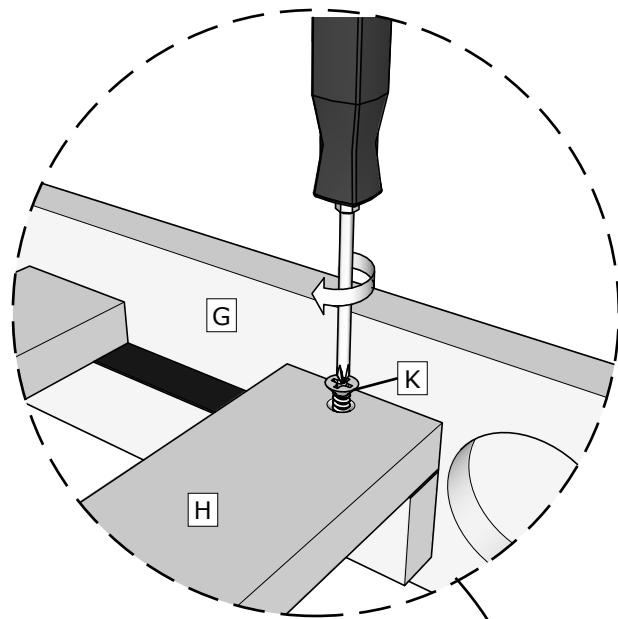
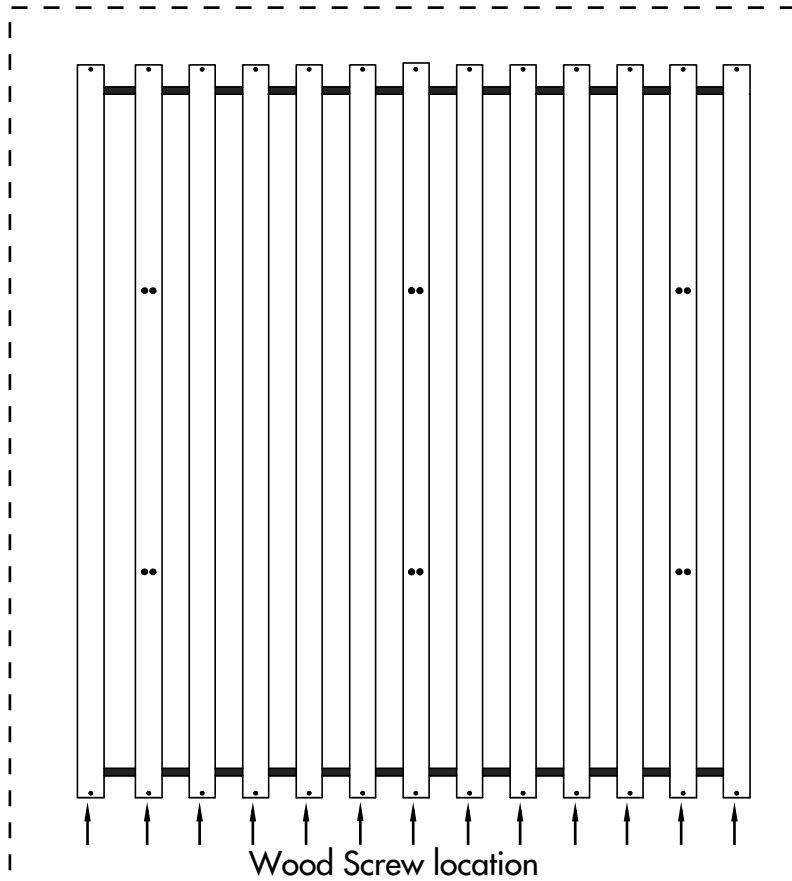

Note: The arrow mark found here indicates that this side should connect to the headboard side.

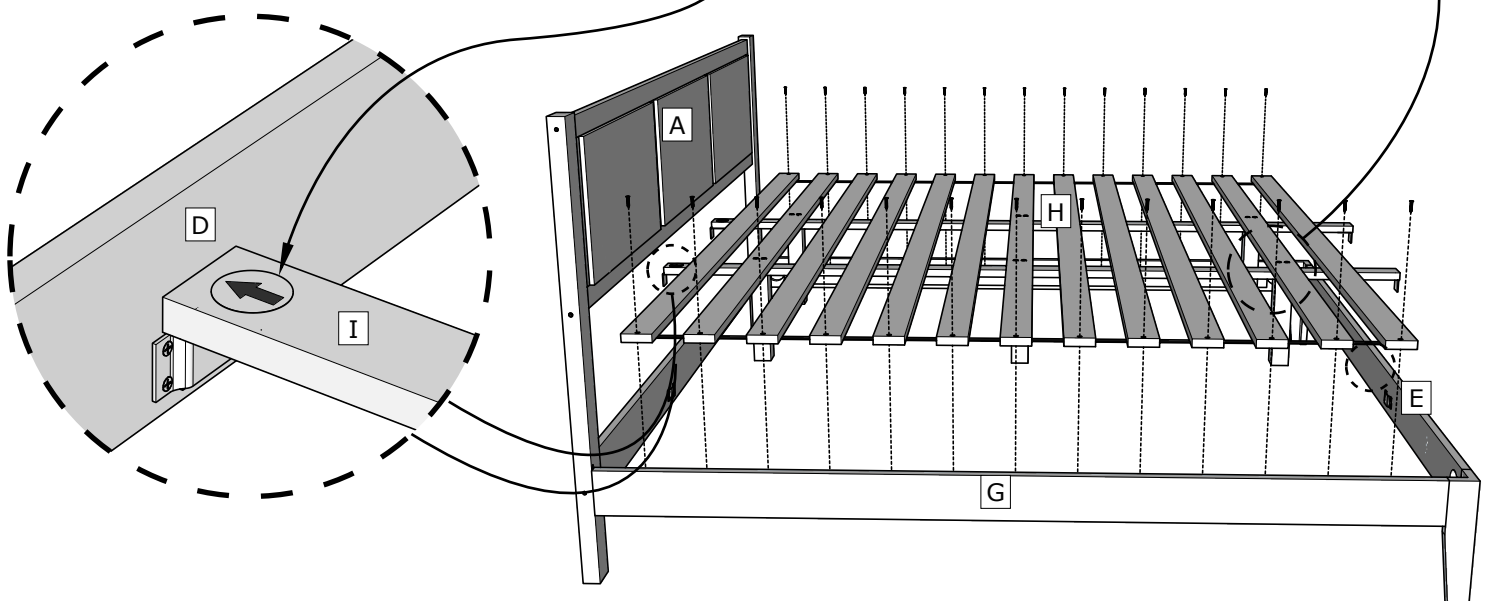

Attach Assembled Bed Slat to Assemble Bed Frame with **K** using a Philips Screwdriver as shown.

# BED ASSEMBLY STEP 7

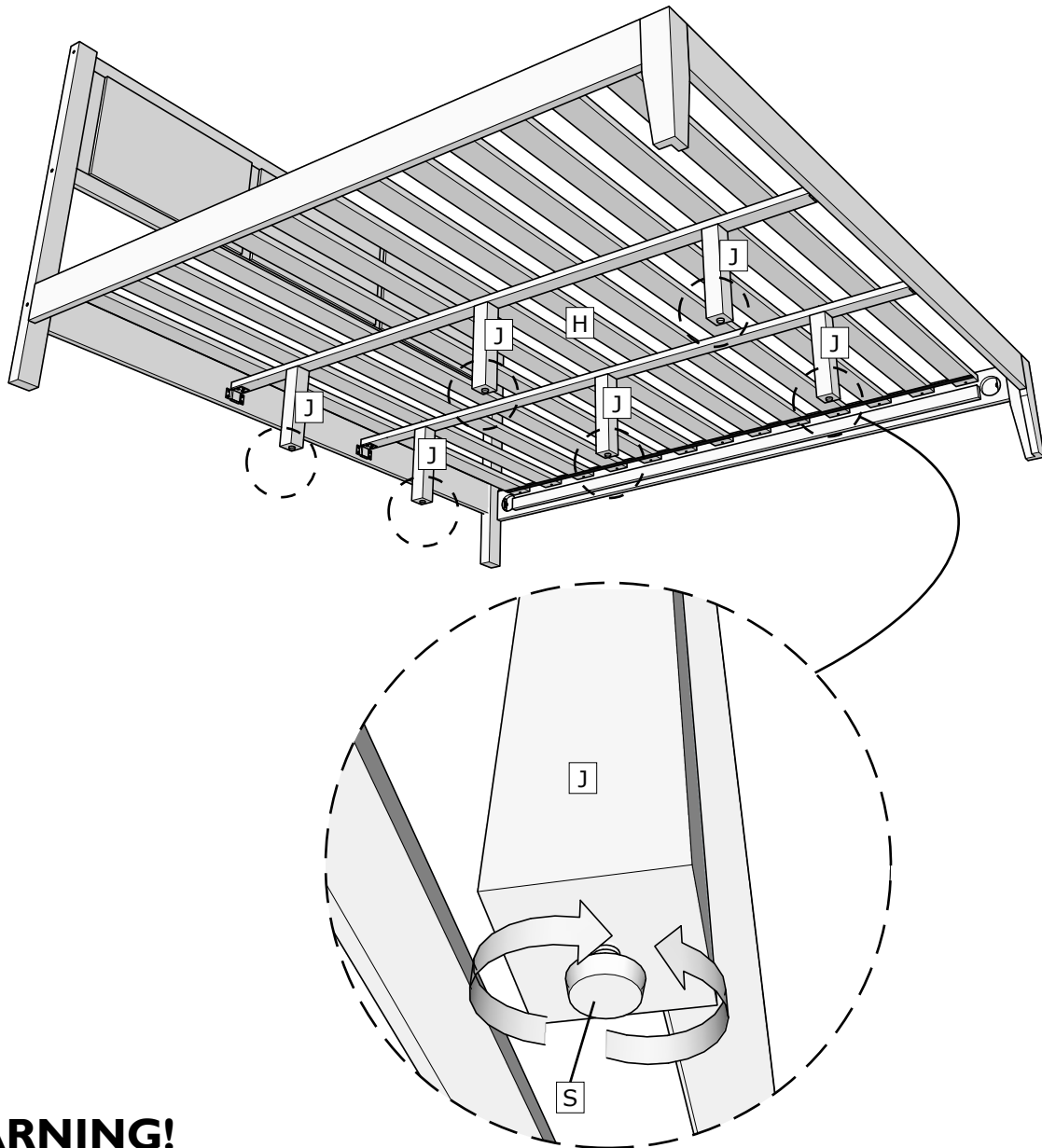

## **WARNING!**

- Ensure the adjustable feet are perpendicular to the floor before using the bed. Rotate them clockwise or counterclockwise until firmly against the floor.

**Note:** *The adjustable feet rotate to fit the floor; one may need clockwise rotation while the other counterclockwise, depending on leveling and assembly.*

- Do not drag or push the bed frame. To ensure safe moving, always use two people to lift and re-position the bed frame. Avoid dragging or pushing it across the floor to prevent damage to the legs, slats, and center support legs.

# FAQS FREQUENTLY ASKED QUESTIONS

---

**WE ARE OPEN MONDAY TO FRIDAY TO ASSIST YOU AND WILL REPLY TO ANY OF YOUR MESSAGES WITHIN 24-48 HOURS. THE AVERAGE RESPONSE TIME IS WITHIN 24 HOURS. IF YOU ENCOUNTER AN ISSUE THAT IS NOT MENTIONED BELOW, PLEASE MESSAGE US IN OUR CONTACT PAGE**

---

**WHERE IS THE REST OF MY ORDER? THE PACKAGE I RECEIVED SAYS CARTON NO. 1 OF 3, CARTON NO. 3 OF 5, OR CARTON NO. 5 OF 6 ETC.**

THE MARKETPLACE ONLY ALLOWS 1 TRACKING NUMBER TO BE UPLOADED IN THE SYSTEM. HOWEVER, THE PRODUCT IS SHIPPED IN MULTIPLE PACKAGES. YOU CAN CONFIRM THE NUMBER OF PACKAGES TO RECEIVE BY REFERRING TO THE CARTON NO. PRINTED ON THE PACKAGE THAT WAS DELIVERED TO YOU. FOR EXAMPLE, YOU RECEIVED 1 PACKAGE AND THE PACKAGE SHOWS CARTON NO. 1 OF 3, THEN CARTON NO. 2 OF 3 AND CARTON NO. 3 OF 3 IS IN TRANSIT TO YOU. THE REST OF THE PACKAGES CAN BE DELIVERED WITHIN THE SAME DAY AS THE FIRST PACKAGE OR WITHIN A FEW DAYS. ONCE THE ORDER IS SHIPPED CONFIRMED, OUR TEAM WILL SEND YOU A MESSAGE TO PROVIDE YOU WITH ALL THE TRACKING NUMBER THAT COMPLETES YOUR ORDER. IF YOU DID NOT RECEIVE THIS MESSAGE, PLEASE CHECK YOUR EMAIL'S SPAM FOLDER, OR LOG INTO THE MARKETPLACE ACCOUNT AND SEND US A MESSAGE.

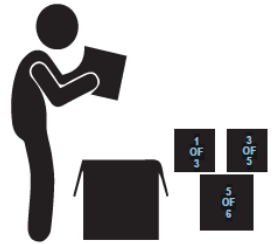

**MY ORDER IS DAMAGED, WHAT DO I DO?**

CONTACT US, INCLUDE THE ORDER NUMBER AND ATTACH APPLICABLE IMAGES TO EXPEDITE THE CLAIM AND ENSURE OUR TEAM WILL PROVIDE THE APPROPRIATE RESOLUTION

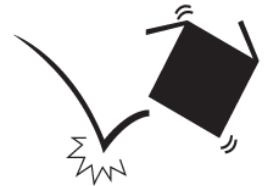

**I TRACKED THE PACKAGE AND IT SHOWS MY PACKAGE WAS DELIVERED, BUT I NEVER RECEIVED THE PACKAGE. I DOUBLE CHECKED WITH MY FAMILY MEMBER AND NEIGHBOR; THEY DO NOT HAVE THE PACKAGE. WHAT DO I DO?**

CONTACT US, INCLUDE THE ORDER NUMBER AND LET US KNOW WHICH CARTON NUMBER OR TRACKING NUMBER YOU DID NOT RECEIVE, AND A TEAM MEMBER WILL REPLY TO YOUR MESSAGE ACCORDINGLY.



**LOVE THE PRODUCT?**

LOG INTO THE MARKETPLACE YOU MADE THE ORDER AND SHARE YOUR EXPERIENCE WITH THE PRODUCT AND WHAT YOU LIKE MOST ABOUT IT. ELEVATE THE PRODUCT REVIEW BY INCLUDING IMAGES OF THE PRODUCT TO SHARE WITH EVERYONE.

