

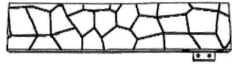

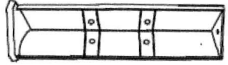

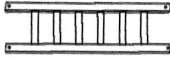

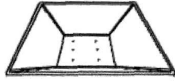

# INSTRUCTION MANUAL

Please check all packing material carefully before discarding, as some parts may be encased in the packing material.

## Part List :

| Part list | Description        | Qty. | Drawings   |
|-----------|--------------------|------|--|
| A         | Top Frame          | 4    |     |
| B         | Leg                | 4    |     |
| C         | Frame Support Part | 4    |     |
| D         | Log Grate          | 1    |     |
| E         | Fire Bowl          | 1    |     |
| F         | Mesh Lid           | 1    |     |
| G         | Lid Ring           | 1    |    |
| H         | Bolt               | 36   |   |
| I         | Poker              | 1    |  |
| J         | Allen Wrench       | 1    |   |
| K         | Cooking Grill      | 1    |   |

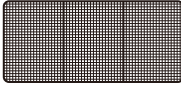
**Tool required: Allen Wrench(provided)**

## **Special Warnings**

- Check local bylaws before using the fire pit.
- This fire pit is intended for Outdoor Use Only! DO NOT use on wooden decks.
- This fire pit is intended to burn Wood logs Only! DO NOT burn coal, leaves or other combustible materials in the fire pit.
- NOT for use by children. Keep children and pets away from the fire pit.
- Fire pit is hot, use with caution. NEVER touch hot fire pit with bare hands.
- NEVER leave burning fire pit unattended and always extinguish fire completely before leaving the fire pit.
- Keep the fire pit at least 20 feet away from any flammable surface or dwelling.
- DO NOT use near flammable or combustible objects or materials.
- Only CHROMED PLATED COOKING GRID is intended for cooking.LOG GRATE is NOT intended for cooking and SHOULD NOT be used for this purpose.
- Always use gloves and protective glasses when loading the fire pit or extinguishing the fire.
- Have a fire extinguisher available near the fire pit in case of emergency.

## **Operation Instructions**

- Place wood logs on grate and light with match. DO NOT overload logs.
- Please use Poker (provided) when handling.
- We do not recommend pouring water over the fire unless necessary. The fire should be allowed to expire on its own.

## **Care and Maintenance**

This fire pit is a quality-built product and is made to last for many years. The frame structure of this unit is made of powder-coated steel extrusion and should resist rusting under normal use. Should rusting occur, we suggest using a steel brush on the affected area followed by a spray coating of high temperature anti-rust paint. For additional rust proofing of the bowl, grate and mesh lid we recommend that a coat of high temperature primer is applied before use. You may cover the fire pit with a protective Cover when the fire pit is not in use. Ensure the fire pit has completely cooled down before using the Protective Cover.

## Assembly Instruction:

Estimated Assembly Time:20 Minutes

DO NOT over tighten the hardware.

**Step1)** Place parts on a smooth even surface, Fix 4 Pieces TOP Frame (A) by using Bolt (H) into Square frame (View Fig.1).

[16 X (H)].

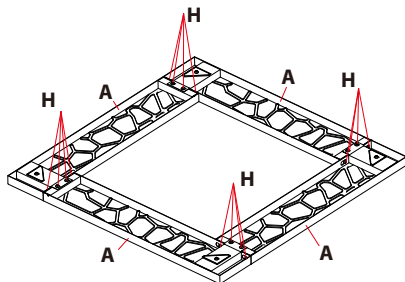

**Step 2)** Attach Frame Support Parts (C) to Legs (B) by using Bolts (H). Tighten all hardware accordingly with an Allen Wrench (J) (provided) and adjustable wrench until all pieces fit together securely. Turn the assembled fire pit frame over so that it sits securely (legs down) on a flat surface (View Fig.2).

[16 X (H)].

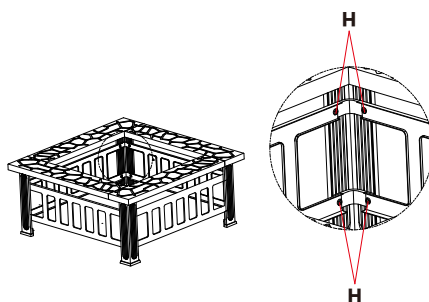

**Step 3)** Attach Legs (B) to Top Frame (A) with Bolts (H) Hand tighten (View Fig.3 !

[4 x (H)].

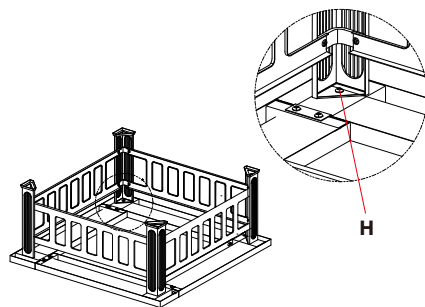

**Step 4)** Place Fire Bowl (E) in the center of TOP Frame (A) and put Log Grate (D) in the Fire Bowl (E). Mount Lid Ring (G) on the Mesh Lid (F), Then place the assembled Mesh Lid over the Fire Bowl (E)(View Fig.4).

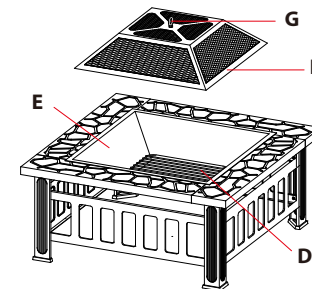

### WARNING!

- The use of alcohol, prescription or non-prescription drugs may impair the ability to properly assemble or safely operate this fire pit.
- When using this fire pit, exercise the same precautions you would with any open fire.
- Do not use this fire pit for indoor heating. Toxic carbon monoxide fumes can accumulate and cause asphyxiation or death.