

INSTRUCTION MANUEL ENCLOSED

ATTENTION

IF YOU HAVE ANY PROBLEMS OR QUESTIONS, PLEASE EMAIL OR CALL THE CUSTOMER SERVICE BEFORE YOU RETURN THIS PRODUCT TO THE STORE WHERE YOU PURCHASED FROM.

INSTRUCTION MANUEL ENCLOSED







OUTDOOR DINNING TABLE



OUTDOOR DINNING TABLE ASSEMBLY INSTRUCTION



Part	PARTS LIST Description	Quantity
	<i>PARTS</i>	
A	Table Feet	2
B	Table Top	1
C	Reinforce Pole	1
	<i>HARDWARE</i>	
D	Bolts 15mm	4
E	Bolts 20 mm	8
F	Washers M6	12
H	Allen Key	1

A	B	C	D	E	F	H
						
2PRS	1PC	1PC	4PCS 15mm	8PCS 20mm	12PCS M6	1PC

PLEASE READ AND FOLLOW ALL SAFETY TIPS

GETTING STARTED

1. Before assembly, CAREFULLY use scissors or utility knife to cut and unwrap all parts. Make sure you do not discard the hardware.
2. Make sure that you have all the parts listed. If you are missing any parts, please contact Customer Service. Please write down the parts you need, model number, and your name and address as well.

***Do not fasten the bolts before finishing all steps.

1. Locate the Reinforce Pole(C) to both side Table Feet(A) by aligning the pre-drilled holes. Each Washer(F) goes with one Bolt(D). Half-fasten the Bolts(D) by hand. Each foot should have 1 fastened bolt. (Photo 1)

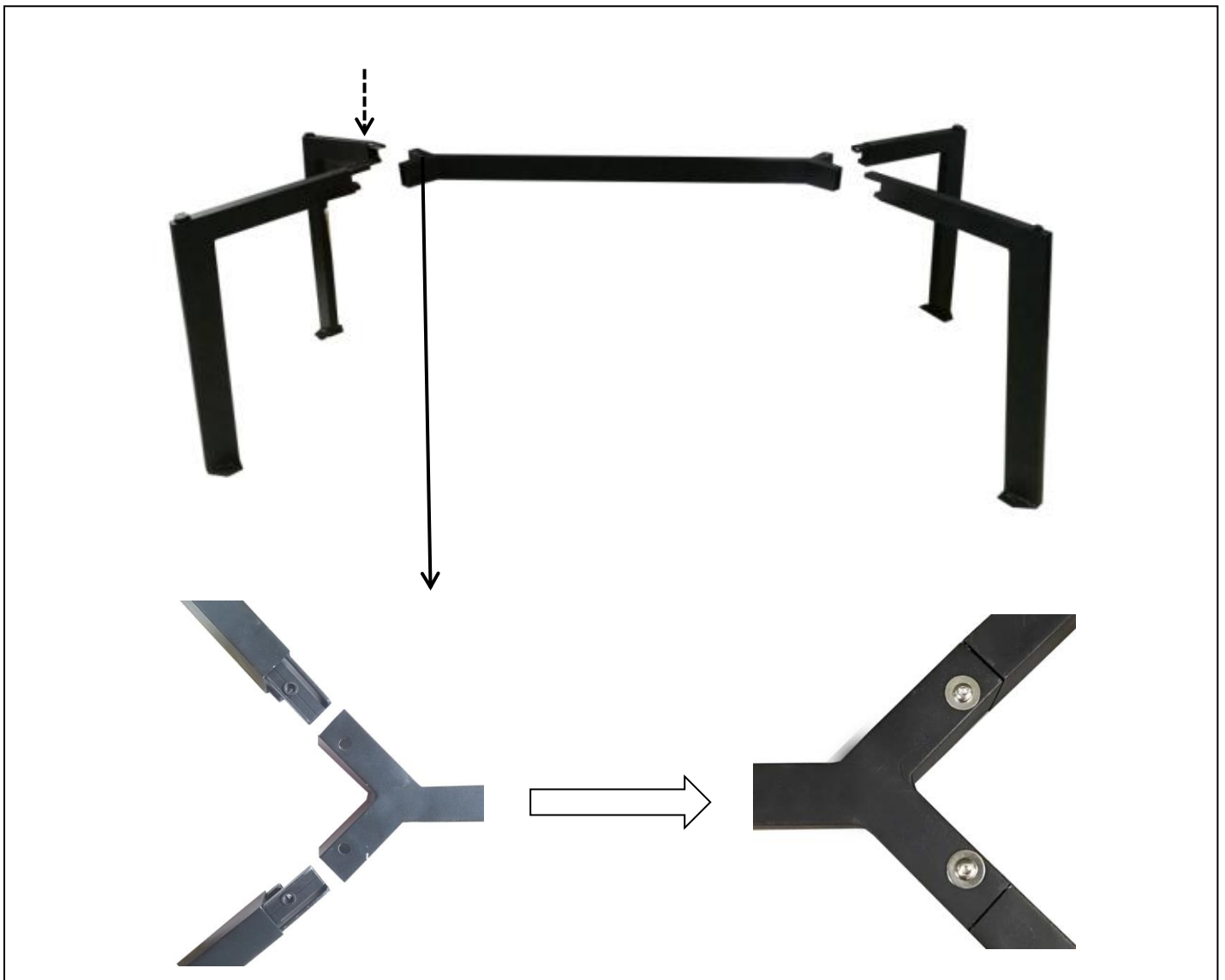

2. Locate the Table Top(B) to the Table Feet(A) by aligning the pre-drilled holes. Each Washer(F) goes with one Bolt(E). Half-fasten the Bolts(E) by hand. Each foot should have 2 fastened bolts. (photo 3)



3. Fasten all the Bolts with the Allen Key.









Till now you have finished the whole assembly and enjoy your furniture.

OUTDOOR BENCH

OUTDOOR BENCH ASSEMBLY INSTRUCTION



Part	DESCRIPTION	Quantity
PARTS LIST		
<i>PARTS</i>		
A	Bench Feet	2
B	Bench Top	1
C	Reinforce Pole	1
<i>HARDWARE</i>		
D	Bolts 20mm	12
E	Washers M6	12
F	Allen Key	1

A	B	C	D	E	F
			 20mm	 M6	
2PRS	1PC	1PC	12PCS	12PCS	1PC

PLEASE READ AND FOLLOW ALL SAFETY TIPS

GETTING STARTED

1. Before assembly, CAREFULLY use scissors or utility knife to cut and unwrap all parts. Make sure you do not discard the hardware.
2. Make sure that you have all the parts listed. If you are missing any parts, please contact Customer Service. Please write down the parts you need, model number, and your name and address as well.

***Do not fasten the bolts before finishing all steps.

1. Locate the Reinforce Pole(C) to both side Bench Feet(A) by aligning the pre-drilled holes. (Photo 1)

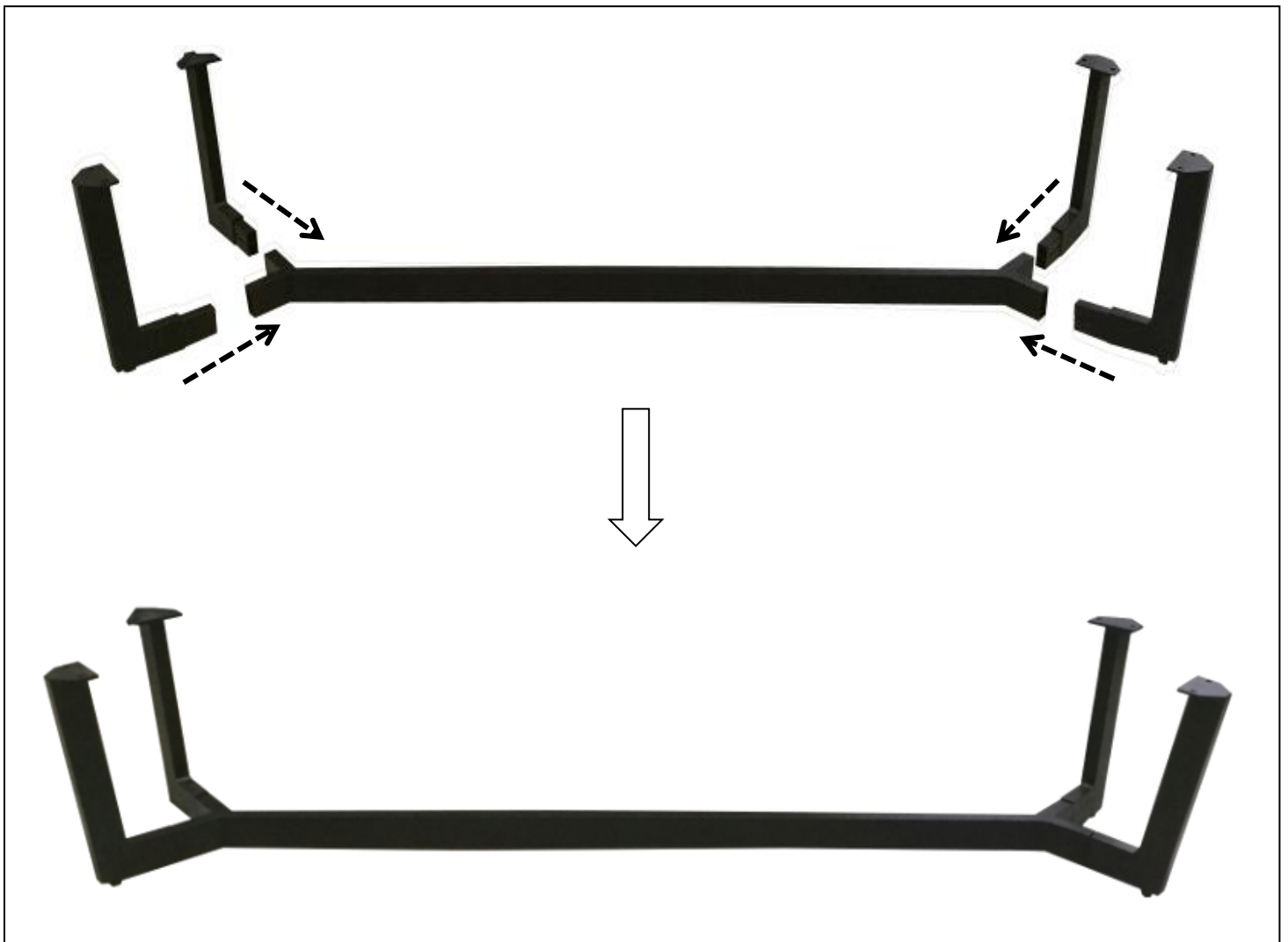

2. Each Washer(E) goes with one Bolt(D). Half-fasten the Bolts(D) by hand. Fasten the Bolts(D) with the Allen Key(F). Each foot should have 1 fastened bolt. (photo 2)

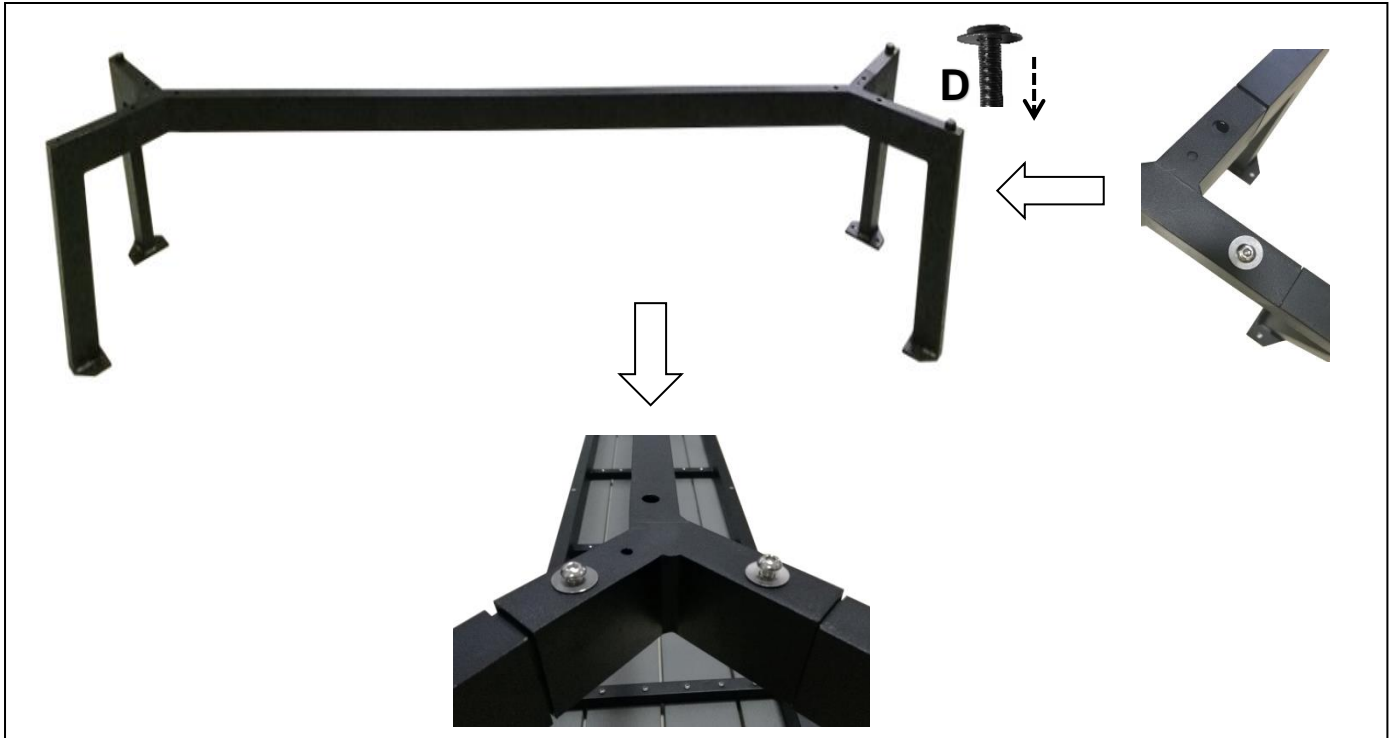

3. Locate the Bench Top(B) to the other end of the Bench Feet(A) by aligning the pre-drilled holes. Half-fasten the Bolts(D) by hand. Fasten the Bolts(D) with the Allen Key(F). Each foot should have 2 fastened bolts. (photo 3)



4. Fasten all the Bolts with the Allen Key.



Till now you have finished the whole assembly and enjoy your furniture .