

TOV



Follow us!

Show your new purchase some love by tagging it on our Instagram!

 @tovfurniture

 516-888-3355

 hello@tovfurniture.com

 www.tovfurniture.com

If the future is female—your furniture should be, too. No mahogany in sight. Sexy settees shaped like lips. Price points for any budget. At TOV, we do things differently.



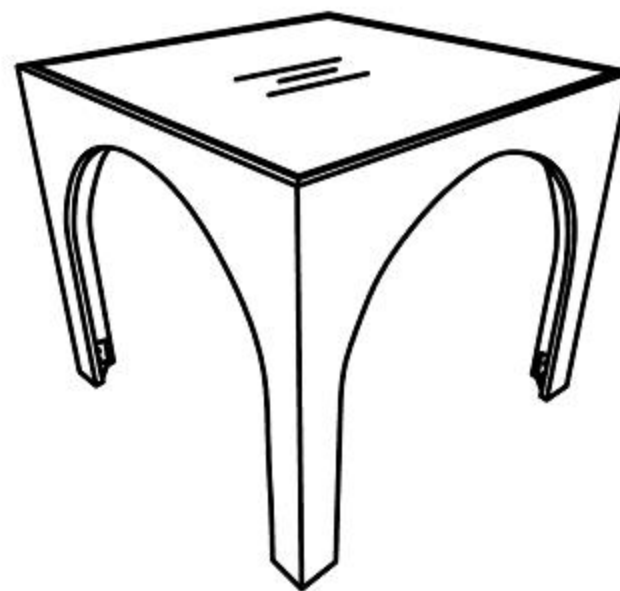



TOV

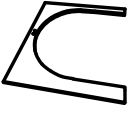
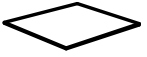

Tomlin Gaming Table

DON'T BE BORING.

Hardware and Components

	-----	(A) X 4 PCS LEG
	-----	(B) X 1 PC TOP
	-----	(C) X 1 PC GLASS
	-----	(D) X 8 PCS
	-----	(E) X 36 PCS (Ø1/4"x10mm)
	-----	(F) X 1 PC
	-----	(G) X 4 PCS
	-----	(H) X1 PC

Step 1

Open box of hardware and legs.

The hardware is packed in small plastic bags inside the hardware box.
Look for the red streamer.

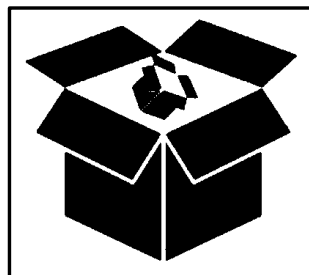

Step 2

- Place 2 Side Legs (A) face upside down on a clean, non-marring surface (i.e. packing foam) as shown below.
- Connect the 2 Side Legs (A) by using Corner Bracket (D) with Bolt (E) and Allen Wrench (F).
- Repeat 3 times, connect all Side Legs to set up the table frame.

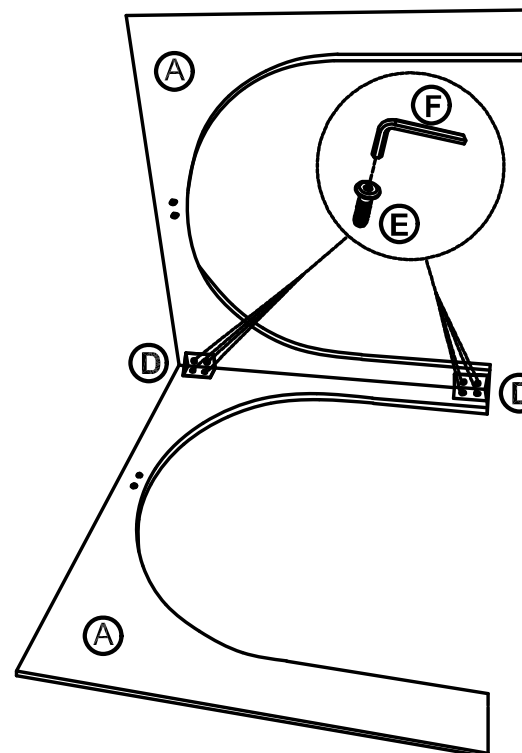

Step 3

- A. Rotate the Leveller (G) clockwise into the Corner Bracket (D) at the bottom of the Side Leg (A).
- B. Repeat 3 times to assemble the other 3 levellers.
- C. Turn the table frame up to standing position.

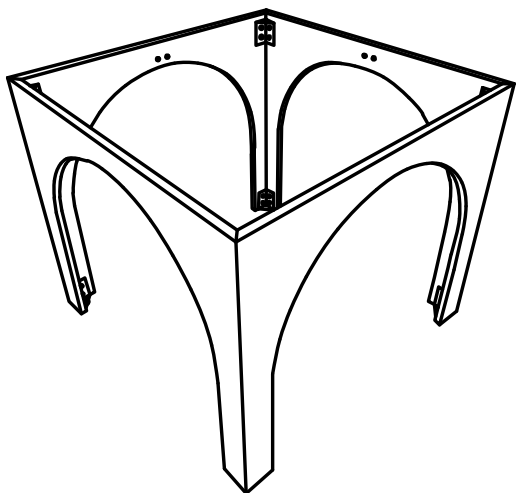
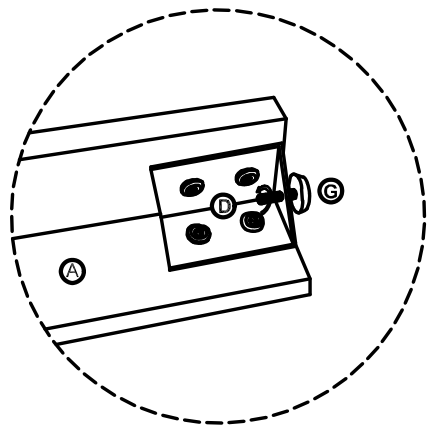

Step 4

- A. Locate and install the Connector Bar (H) by using Bolt (E) and Wrench (F).

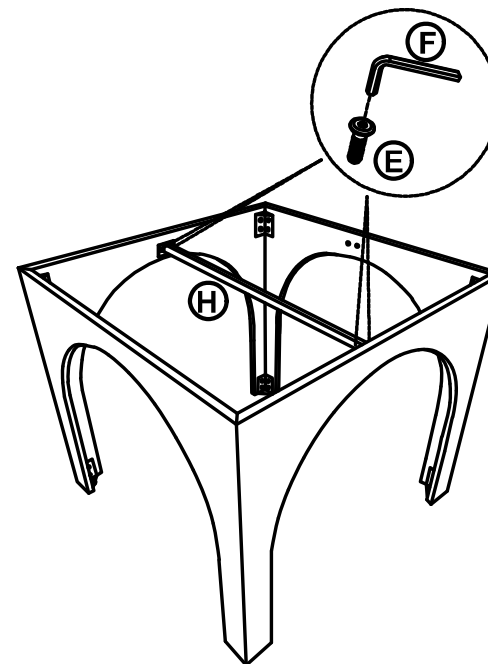

Step 5

- A. Put down the Top (B) into the Table Frame.
- B. Put down the Glass (C) on top of the Top (B).
- C. Complete.

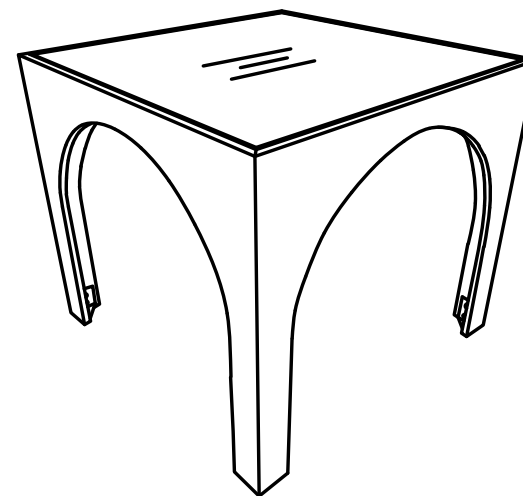
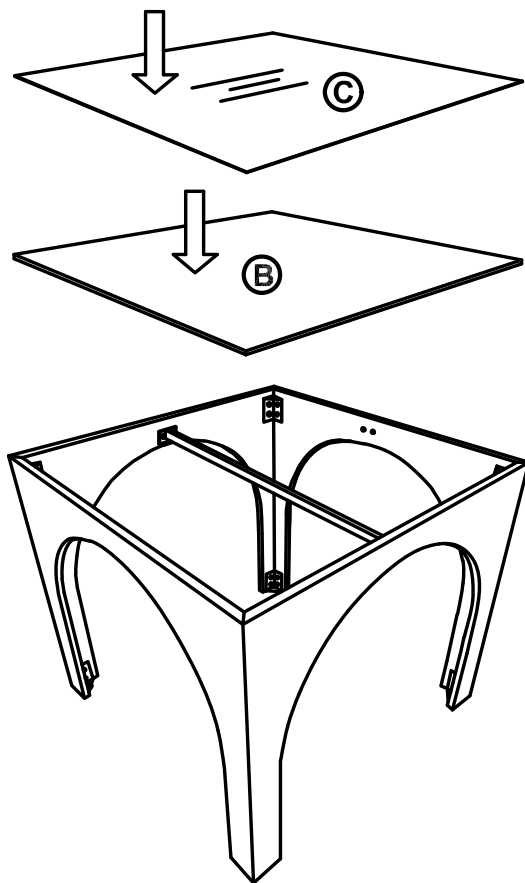

Stuck?
Contact our team @ 516-888-3355

Scan for product care!

