

Assembly instructions for the chair, including warnings, time, and person requirements.

Warning 1: Do not use a power drill. Use an L-shaped Allen key instead. **Warning 2:** Do not use a power saw. Use a hand saw instead.

Time: 15'

Personnel: 1

A

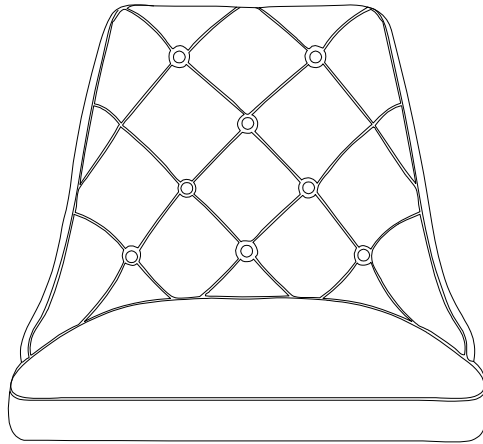

B x 2

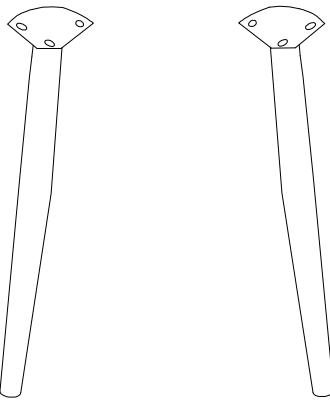

C x 2

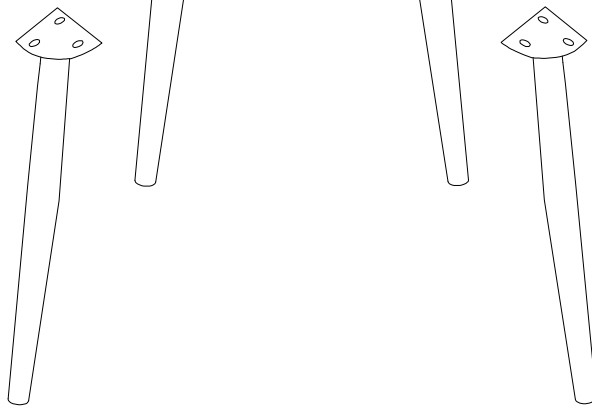

A

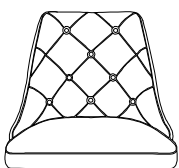

x 1

B



x 2

C



x 2

D

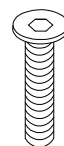

M6
x
20

x 12

E

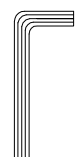

x 1

1

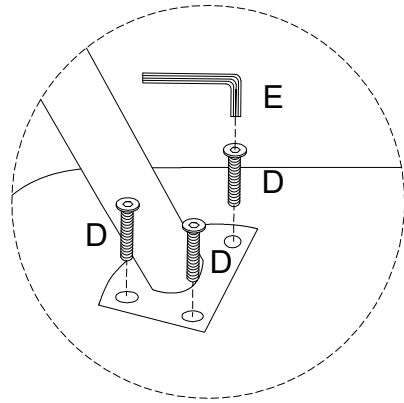
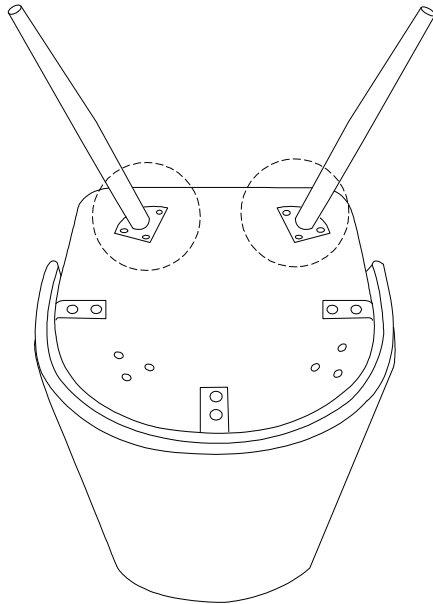
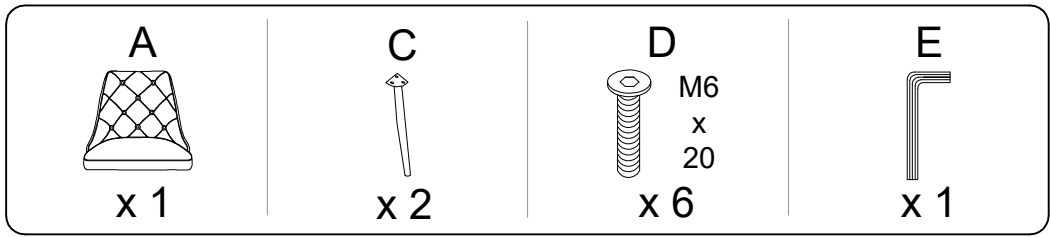

2

