

MIRROR

ASSEMBLY INSTRUCTIONS

PARTS AND FITTING PACKAGING DETAIL

BOX MIRROR

A. MIRROR 1 PC

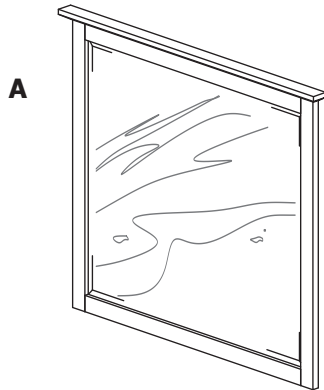

BOX DRESSER 8 DRAWER *

B. DRESSER 8 DRAWER 1 PC
C. MIRROR SUPPORT 2 PCS
HARDWARE** IN PLASTIC PUNCH

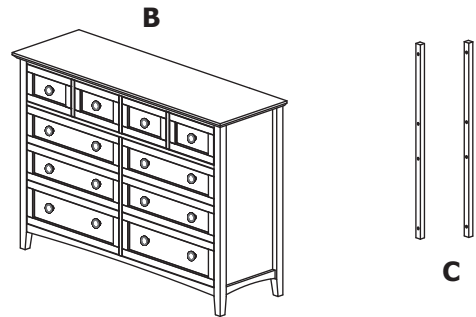

*SOLD SEPARATELY

OPTION 1 FIXING MIRROR ON THE WALL

HANGING ON THE WALL
USING EYE LIDS WHICH
ALREADY INSTALLED

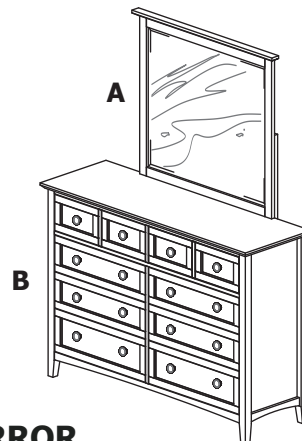
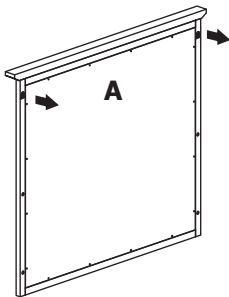

OPTION 2 FIXING MIRROR ON THE DRESSER 8 DRAWER

HARDWARE** PACKED IN BOX DRESSER 8 DRAWER

1	ALLEN BOLTS 40MM	8 PCS
---	---------------------	----------

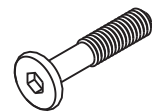

TOOL REQUIRED :

2	ALLEN KEY	1 PC
---	-----------	---------

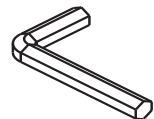

WARNING

FOR YOUR SAFETY AND CONVENIENCE
ASSEMBLY BY TWO PEOPLE IS RECOMMENDED

STEP 1 :

FOLLOW THE ILLUSTRATION TO FIX
MIRROR SUPPORT (C) TO 8 DRAWER DRESSER (B)
USING ALLEN BOLTS (1) FROM BACK SIDE. USE PILOT
HOLES AS REFERENCE FOR EASY ASSEMBLY. INSERT
ALLEN BOLTS (1) TO THE **HOLES** ON THE BACK
SIDE OF DRESSER FOR LANDSCAPE POSITION.
TIGHTEN THE BOLTS USING ALLEN KEY (2).

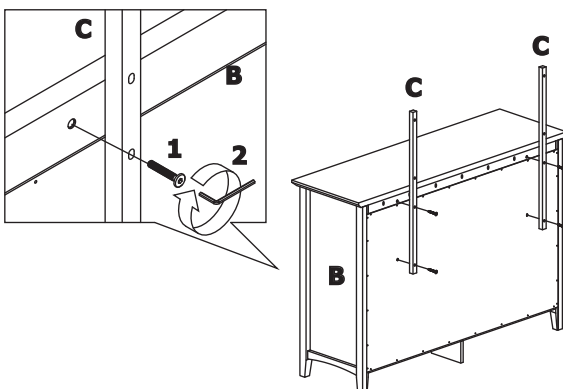

STEP 2 :

USE PILOT HOLES AS REFERENCE TO CONNECT
MIRROR (A) & MIRROR SUPPORT (C) USING ALLEN
BOLTS (1). TIGHTEN THE BOLTS USING ALLEN KEY (2).

