

U-Shaped Sofa

Instruction Manual

SF-UZ6-DKGY

SF-UZ6-BG

SF-UZ6-BN

SF-UZ6-GN

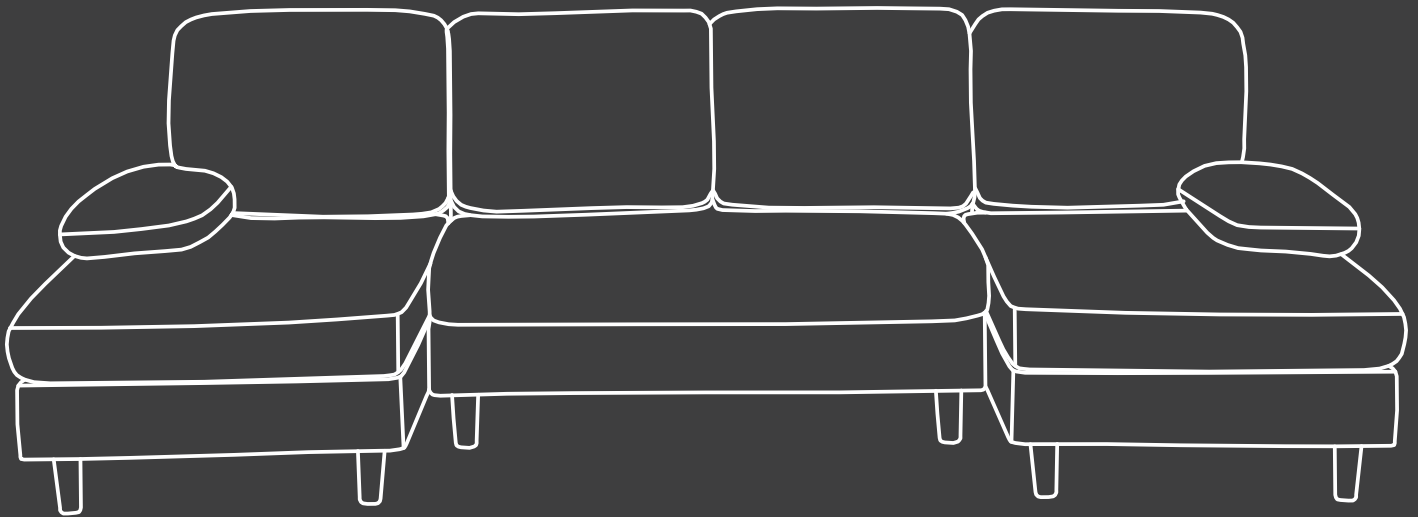

 EST 9:00AM--17:00PM

 HJ-Customer-Service@outlook.com

 (909)637-7665 | (909)637-7593

1 Component List

A1 x1

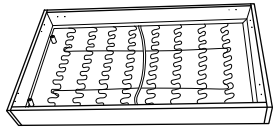

A2 x1

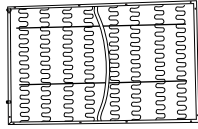

B x1

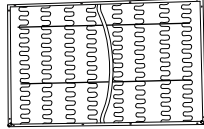

C x2

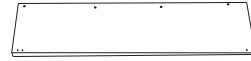

D x2



E x2



F x2



G x2

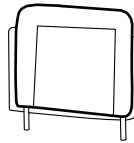

H x1

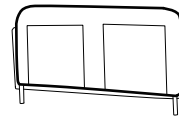

I1 x1



I2 x1



J x1



K x2

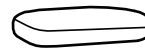

L1 x1



L2 x1



M x2



N x12



O x1



M6

P x24



8*45mm

Q x54



8*20mm

R x12



S x4



T x12



Felt Pads

U x6



Split Lock Washer

Exploded View

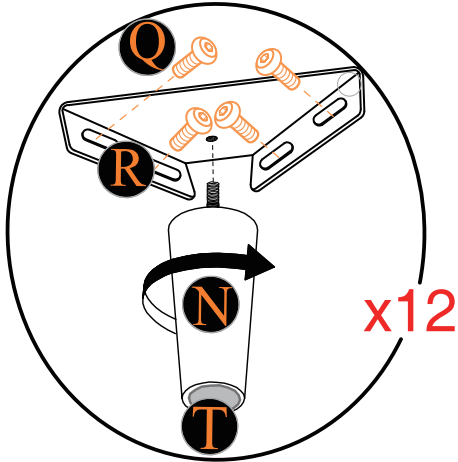
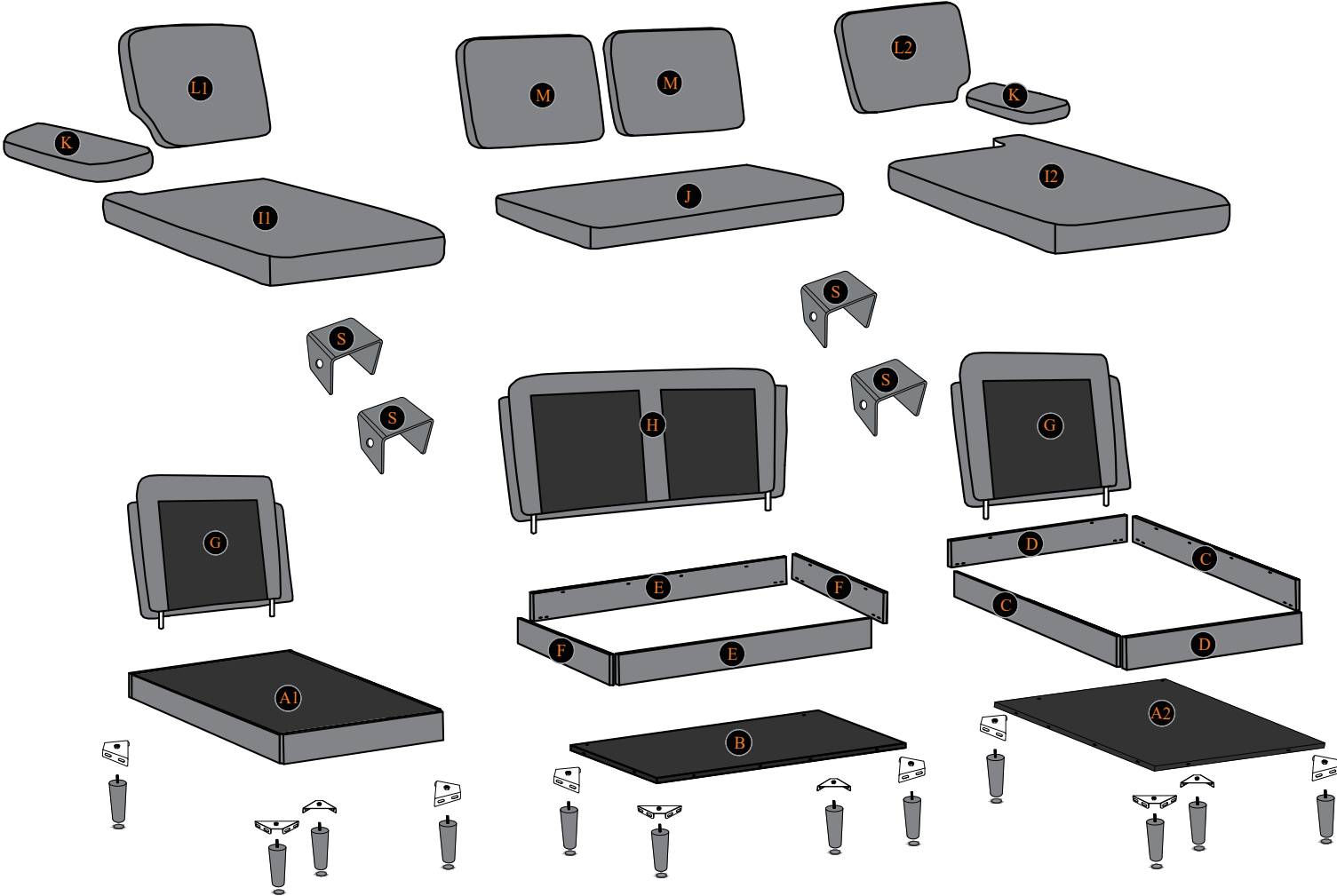



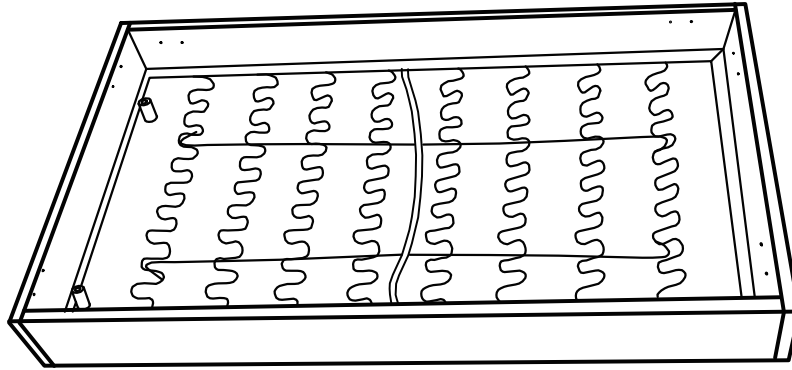

Step 1

A1

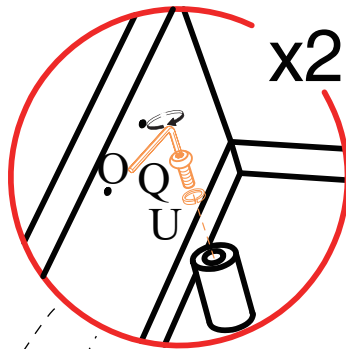
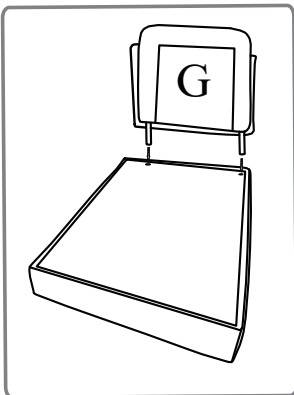

Step 2



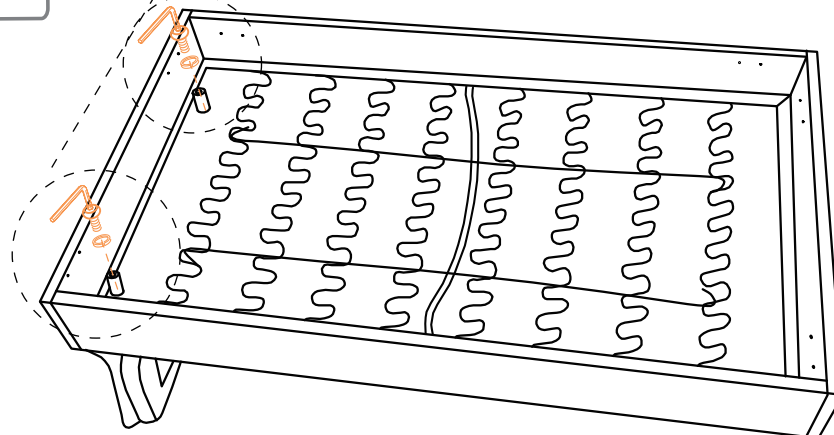

 M6 O*1	 8*20mm Q*2	 U*2
--	--	--

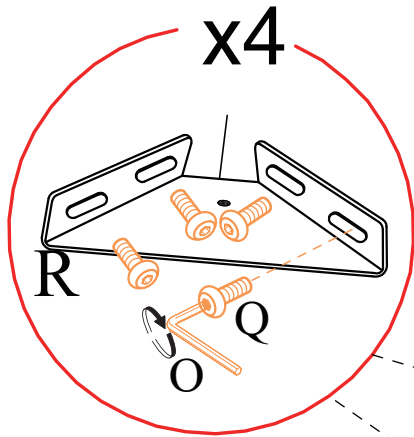

Step 3

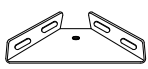

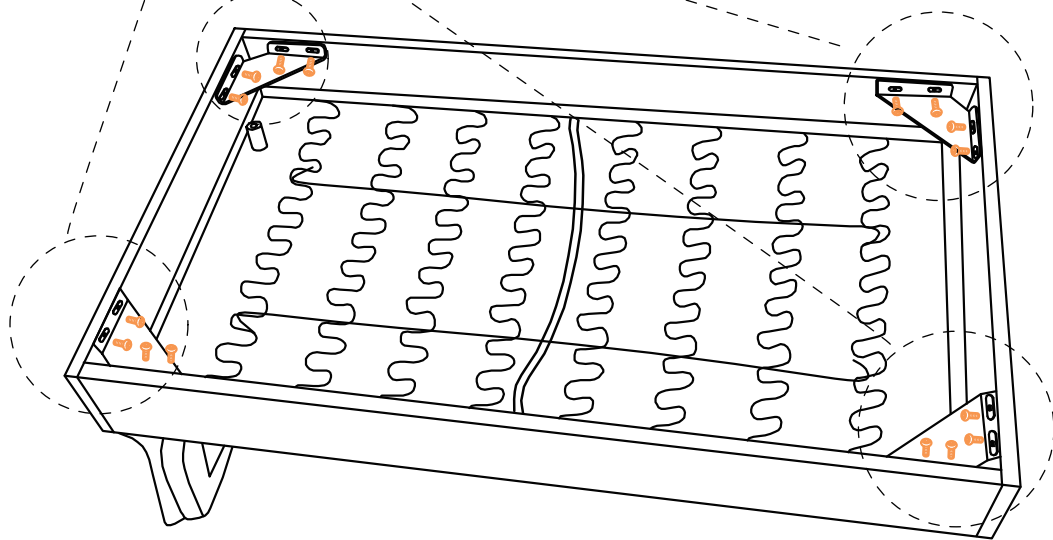

		
R*4	M6 O*1	8*20mm Q*16



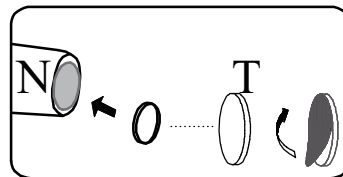
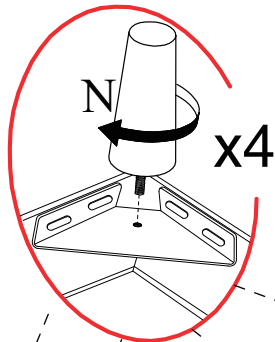

Step 4

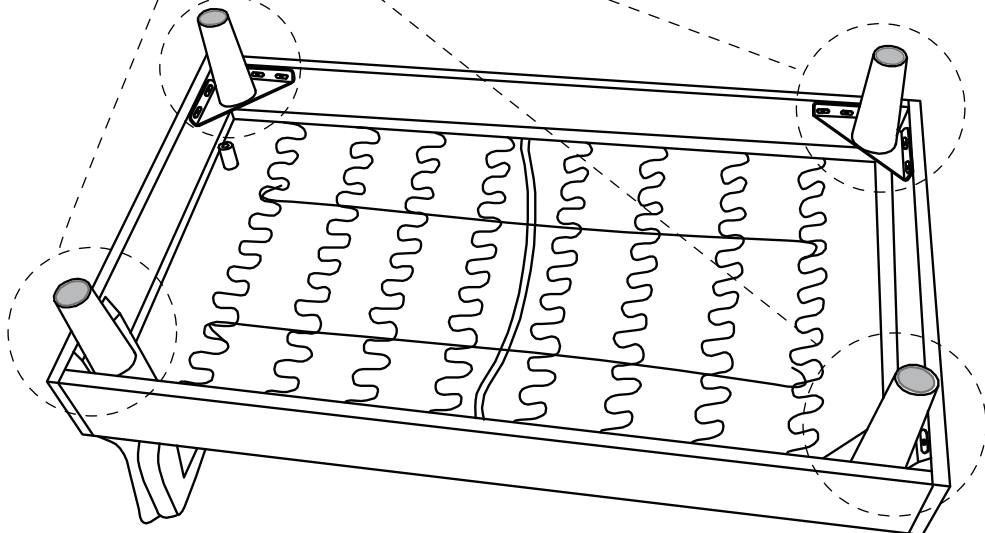

	
N*4	T*4





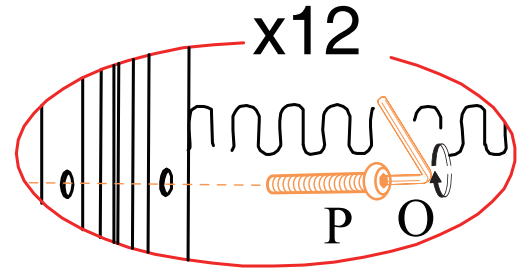
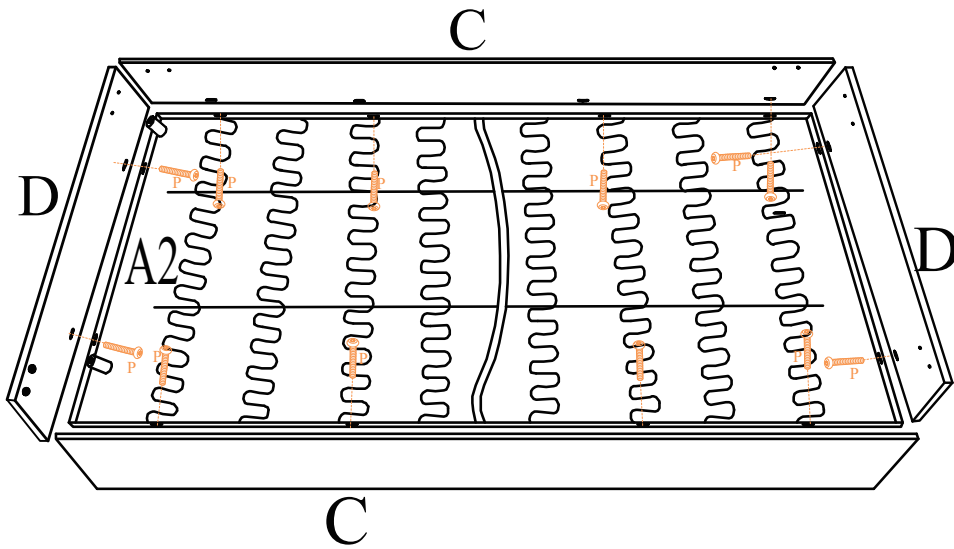

Step 5

	
M6	8*45mm
O*1	P*12

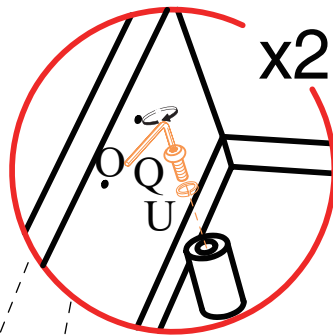
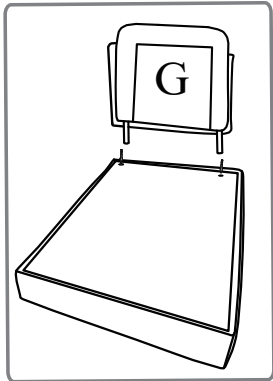

Step 6



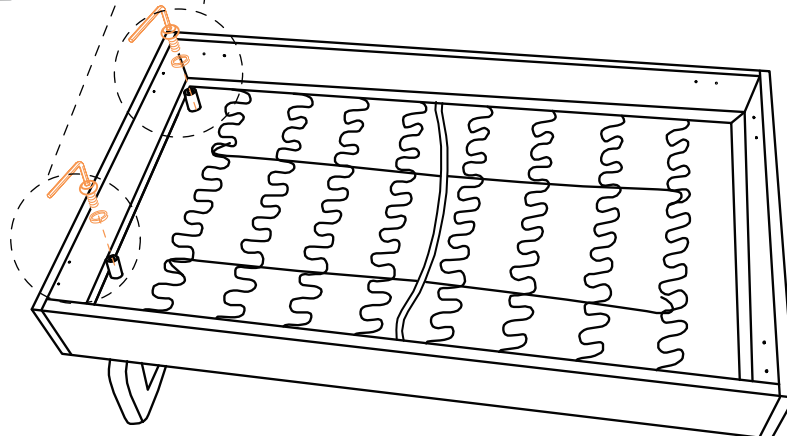

		
M6	8*20mm	
O*1	Q*2	U*2

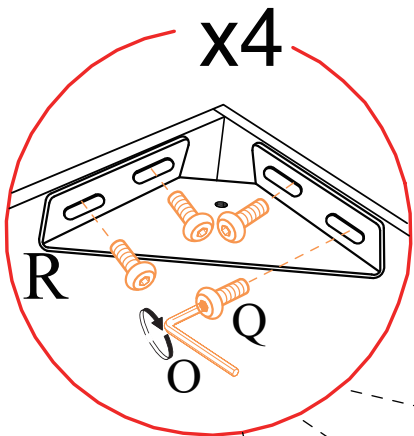

Step 7

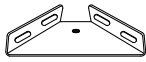

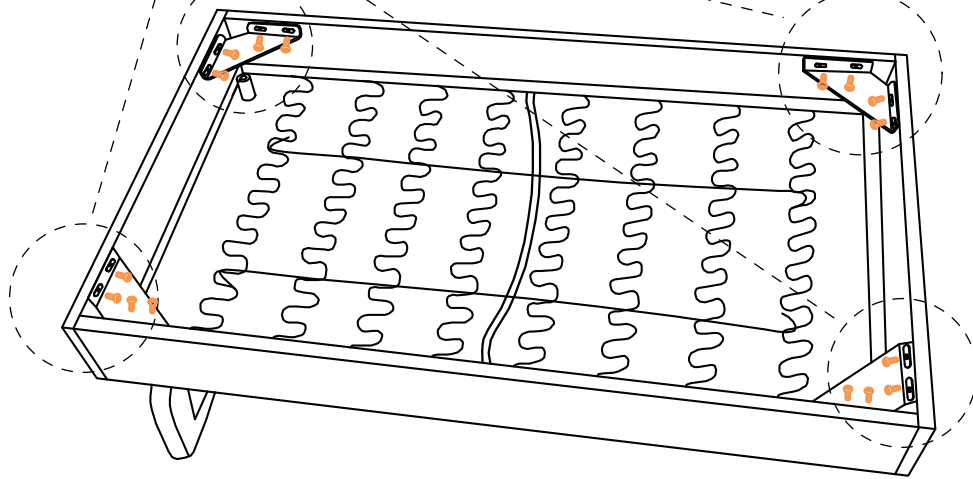

		
R*4	M6 O*1	8*20mm Q*16

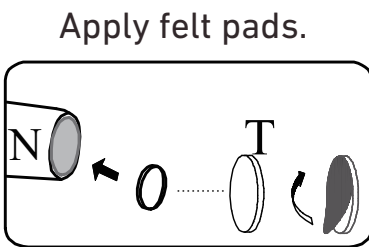
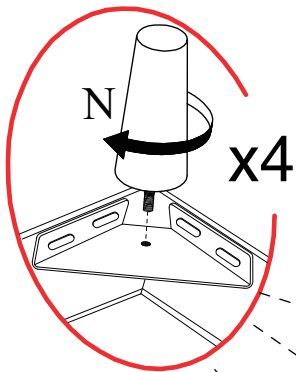

Step 8

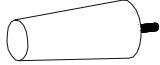

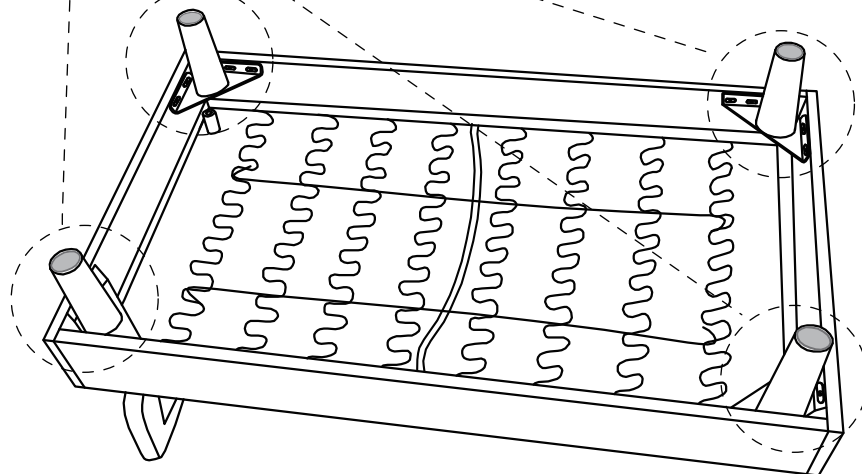

	
N*4	T*4

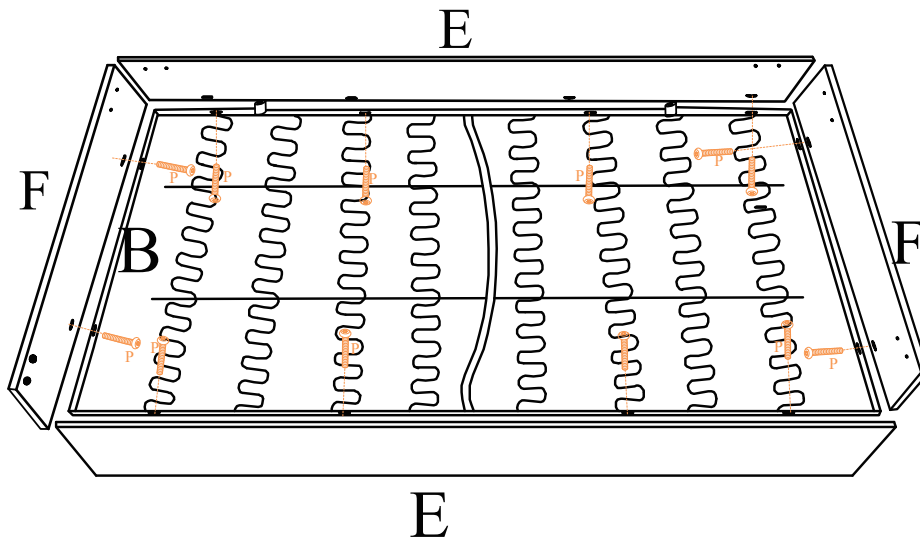

Step 9



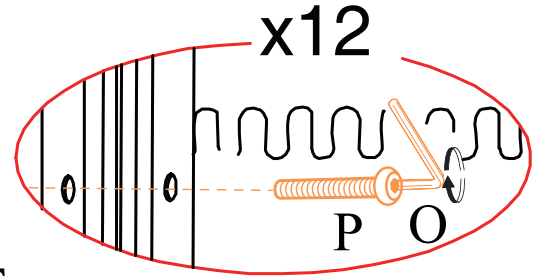

	
M6	8*45mm
O*1	P*12

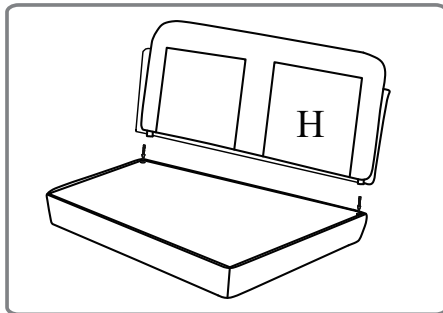

Step 10



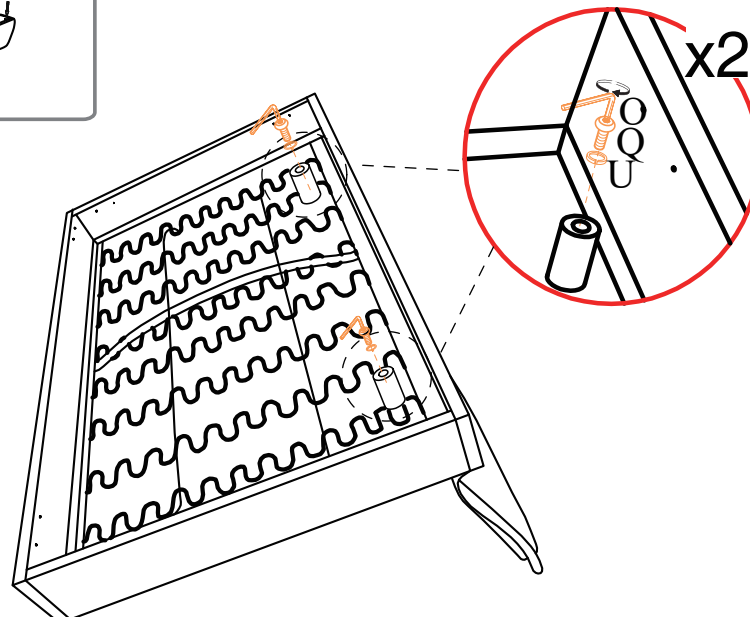

		
M6	8*20mm	
O*1	Q*2	U*2

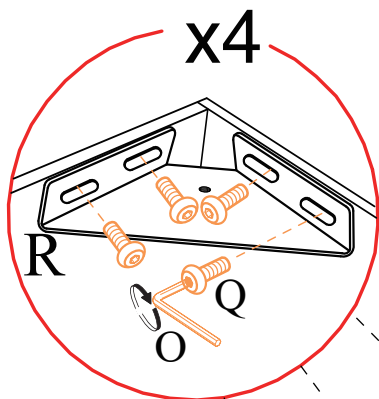

Step 11

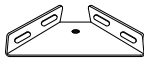

		
R*4	O*1	8*20mm Q*16

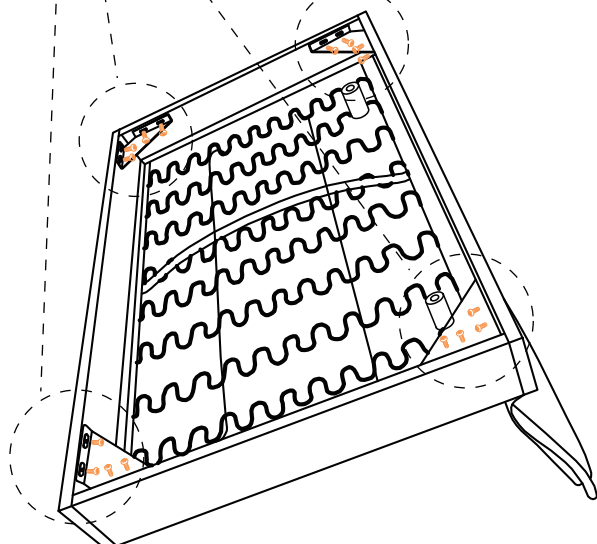

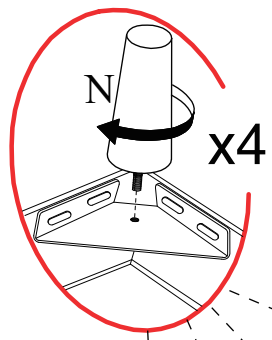

Step 12

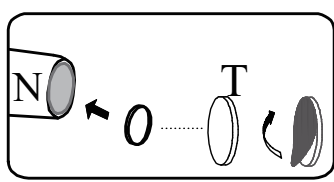

Apply felt pads.

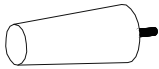

	
N*4	T*4

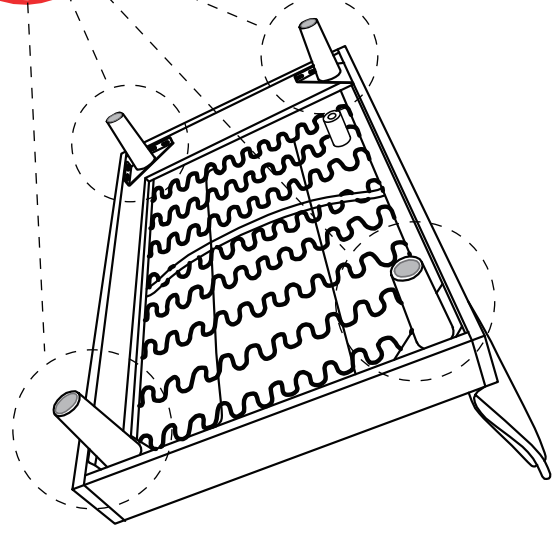

Step 13

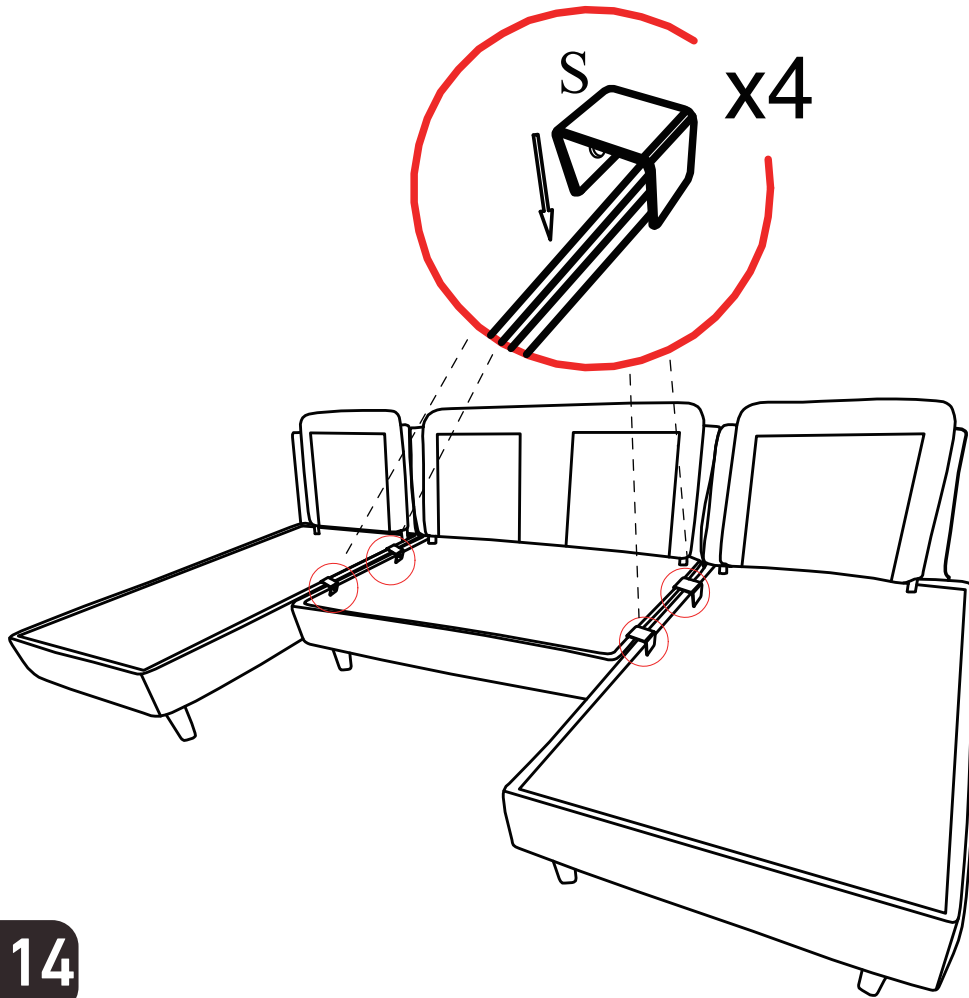

Step 14

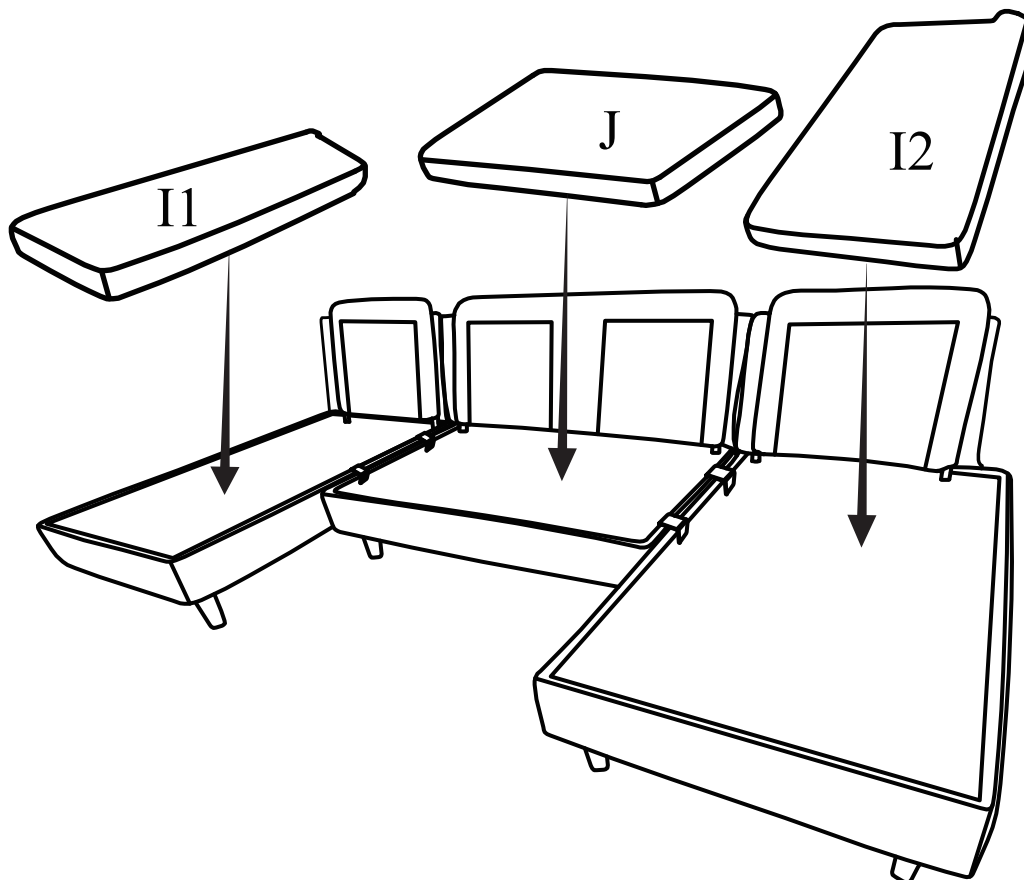

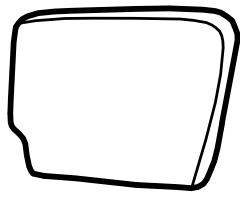

Pat the back cushion/armrest cushion 3 times along with longitude direction

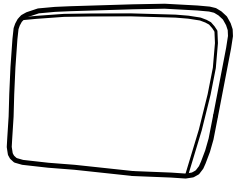
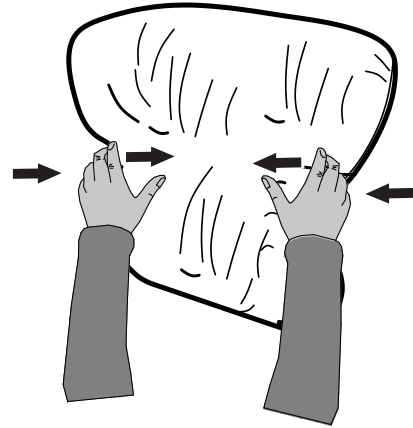
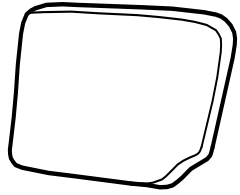

Pat the back cushion/armrest cushion 3 times along with latitude direction

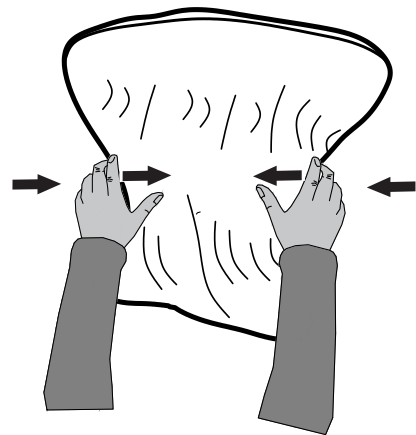

Pat the back cushion/armrest cushion surface 3 times

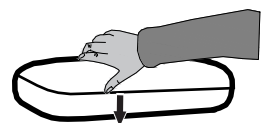
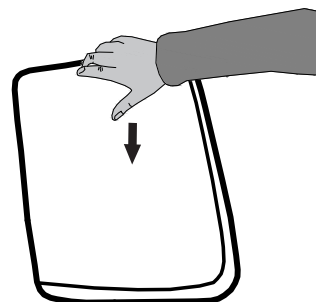
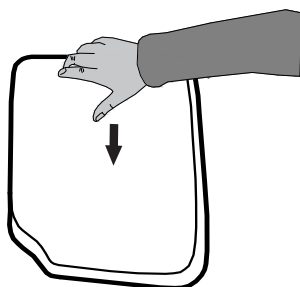
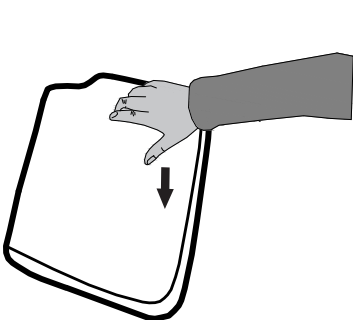

Step 15

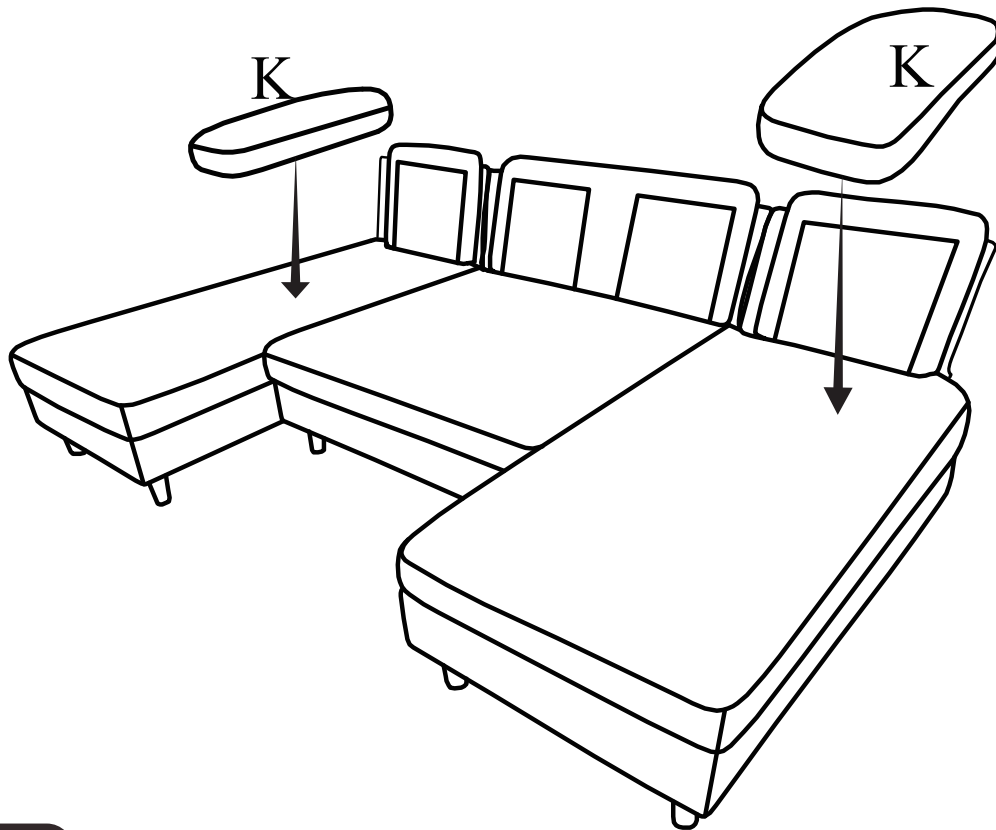

Step 16

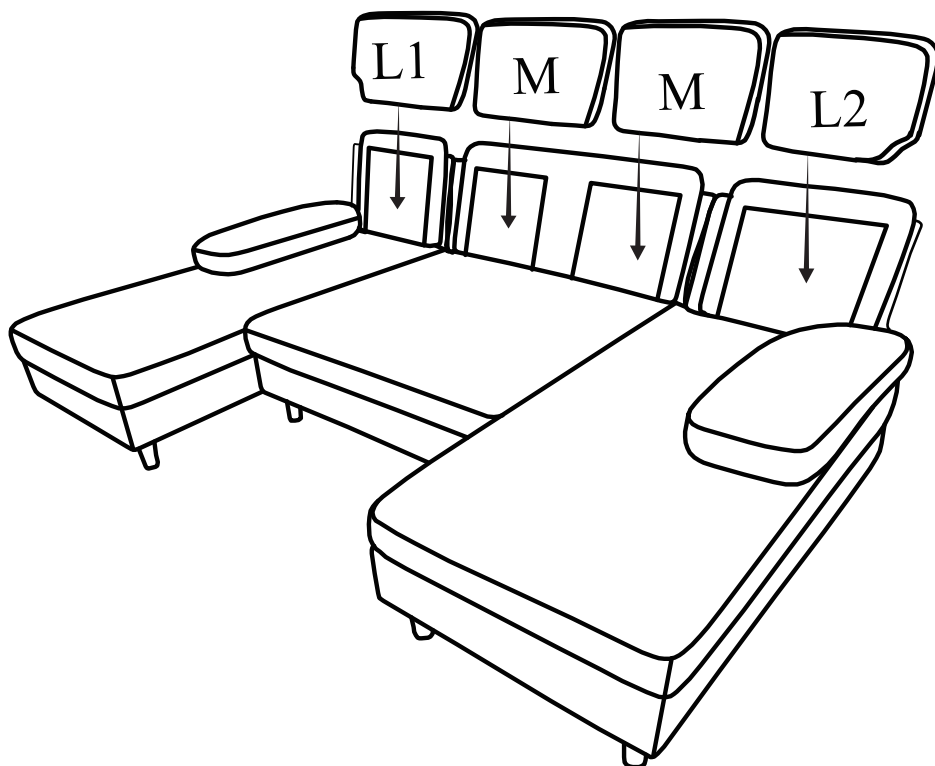

Step 17

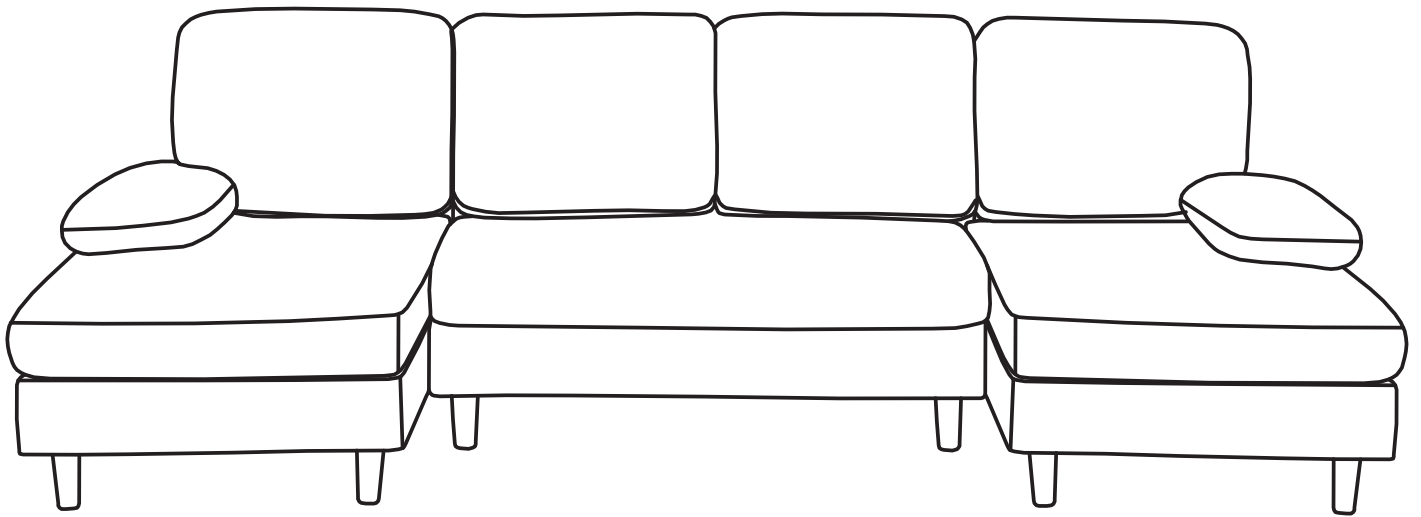

Note:

After assembly, there may be visible compression marks on the surface. Gently pat the affected areas and allow the sofa to rest for 1-2 weeks. The surface will gradually return to its original shape.

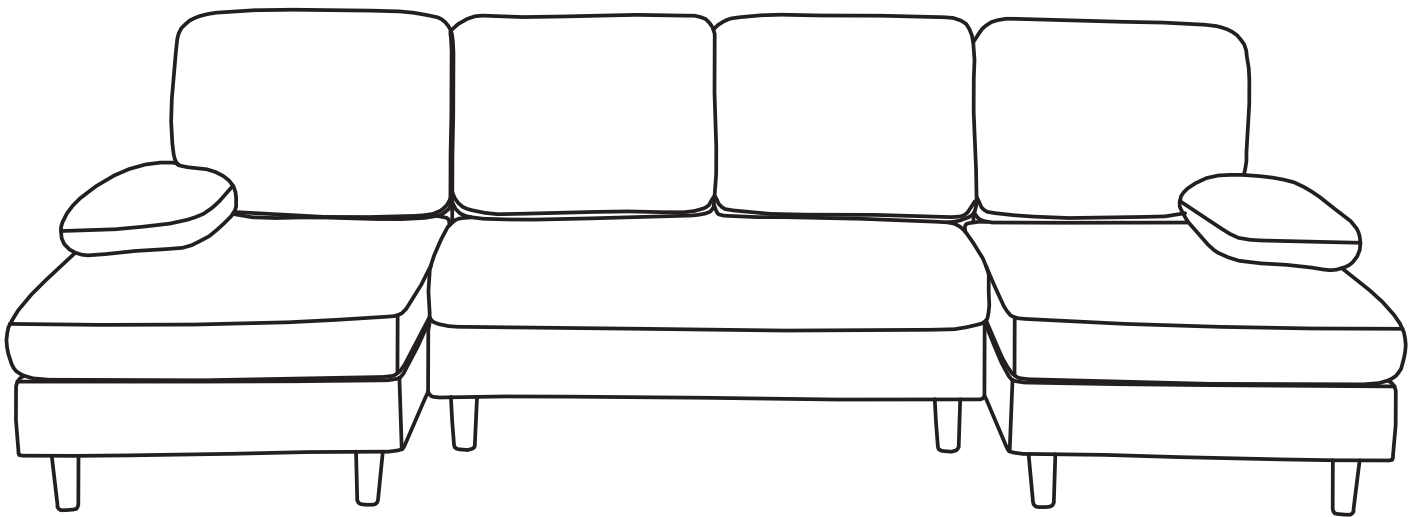

Technical Support

(909)637-7665 | (909)637-7593

Other Info

HJ-Customer-Service@outlook.com

Thank you for choosing this product. We strive to provide you with the best quality products and service in the industry. Should you have any issues, please don't hesitate to contact us.