

WARNING

- * Switch off the main electrical supply from the main fuse box / circuit breaker before installation.
- * Inspect item carefully before attempting to install.
- * If there is any damages or obvious defects, do not install.
- * Item may not be returned once it has been installed.





















CARE AND MAINTENANCE

- * To clean the outside of the fixture, use a dry or slightly dampened clean cloth (use clean water, never a solvent) to wipe the surface of the fixture.
- * To clean the inside of the fixture, first disconnect power to the fixture by turning off the circuit breaker or by removing the fuse at the fuse box. Next, use a dry or slightly dampened clean cloth (use clean water, never a solvent) to wipe the interior surface of the fixture.
- * Do not use any cleaners with chemical, solvents or harsh abrasives. Use only a dry soft cloth to dust or wipe carefully.

NOTICE& IMPORTANT SAFETY INSTRUCTIONS

- ** WE RECOMMEND INSTALLATION OF THIS LIGHTING FIXTURE BE DONE BY A LICENSED ELECTRICIAN **
- * Please make sure that you have all parts indicated before you begin assembly of this item
- * This item should be assembled on a soft surface to prevent scratching the finish during assembly
- * To reduce the risk of fire, electrical shock or injury to persons or property, please follow the guideline below for safe use and installation

Part List and Hardware List

PIECE	DESCRIPTION	PICTURE	QUANTITY	PIECE	DESCRIPTION	PICTURE	QUANTITY
A	Wire Connector		3X	K	Center Rod		2X
B	Mounting Plate		1X	L	Glass		5X
C	Ground Screw		1X	M	Screw		19X
D	Mounting Screw		2X	N	Bulb		5X
E	Canopy		1X	O	Square Tube Pillars		4X
F	Canopy Nut		2X	P	Socket Assembly		1X
G	Short Stem		4X	Q	Bottom Frame		1X
H	Long Stem		4X	R	Cap		2X
I	Hex Nut		2X	S	Allen Wrench		1X
J	Top Frame		1X	T	Screwdriver		1X

Product Dimensions: 38"L x 10"W x 23.25"-53.25"H

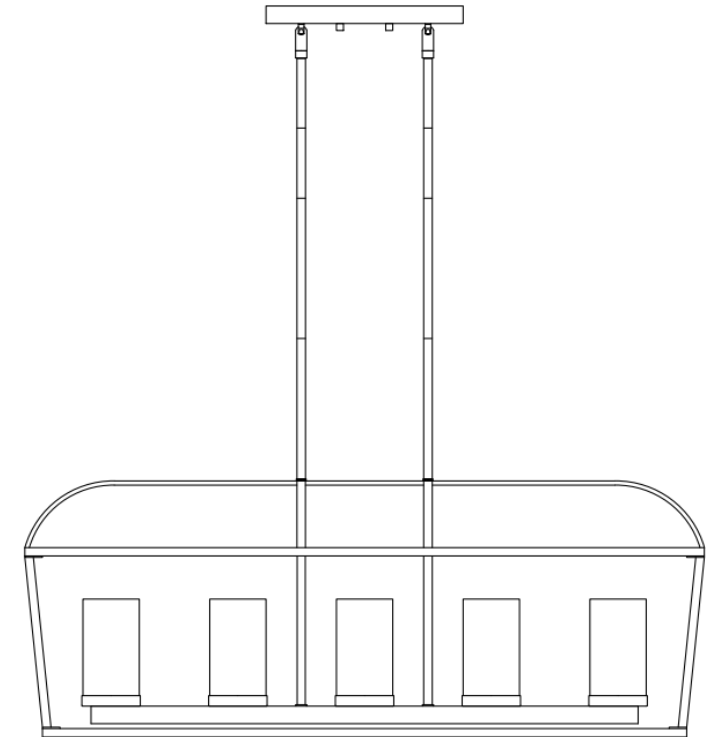

PREPARATION

- * Before beginning assembly of product, make sure all parts are present. Compare parts with package contents list and hardware contents list.
- * If any part is missing or damaged, do not attempt to assemble the product.
- * Estimated Assembly Time: 20 minutes.

NOTE: PLEASE USE TYPE "B" BULB MAX 40-WATT OR LED BULB MAX 9-WATT, THERE ARE 5PCS LED 4-WATT BULB IN THE BOX

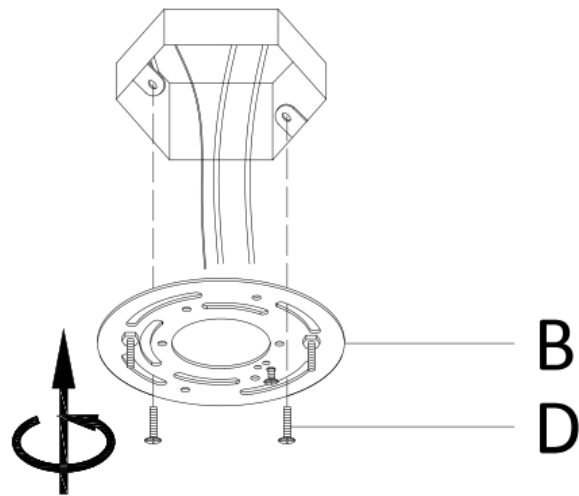

Step 1: Unpack all parts from cartons carefully. Separate the Mounting Plate (B) from the Canopy (E) by removing the Canopy Nut (F) anti-clockwise. Fix the Mounting Plate(B) to the junction box with Mounting Screw (D).

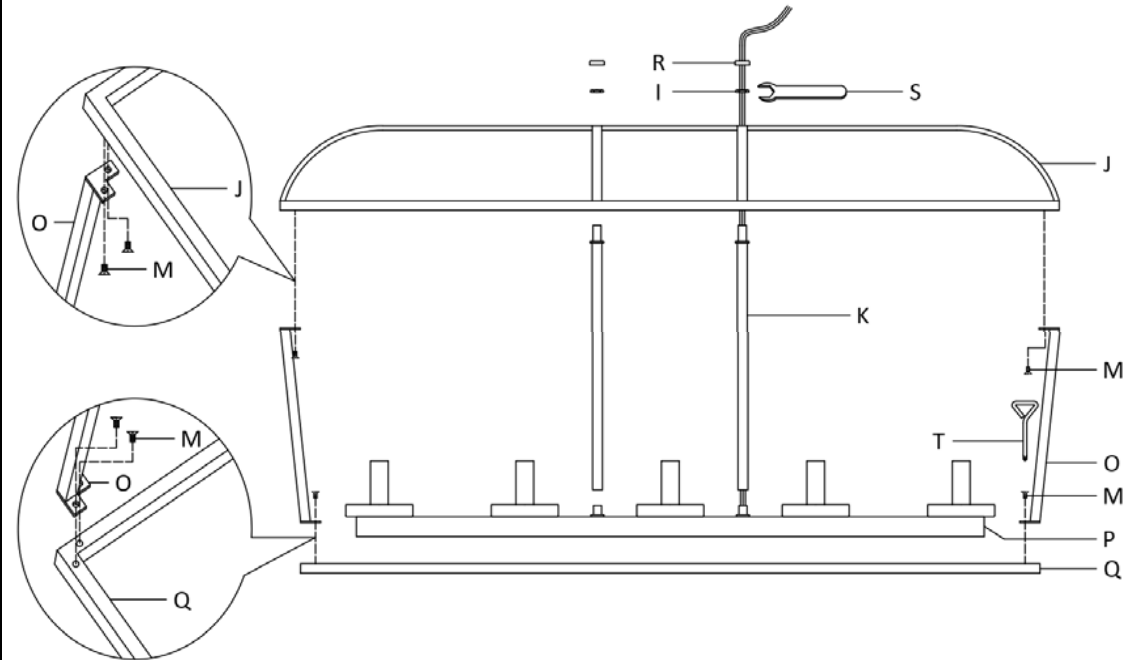

Step 2: Thread Center Rod (K) to Socket Assembly (P), Insert Center Rod (K) to Top Frame (J), then use Allen Wrench (S) secure with the Hex Nut (I). and then cover the Hex Nut (I) with the Cap (R). Use Screwdriver (T), attach the ends of the Square Tube Pillars (O) to the Top Frame (J) and Bottom Frame (Q) with Screw (M) .

PREPARATION

- * Before beginning assembly of product, make sure all parts are present. Compare parts with package contents list and hardware contents list.
- * If any part is missing or damaged, do not attempt to assemble the product.
- * Estimated Assembly Time: 20 minutes.

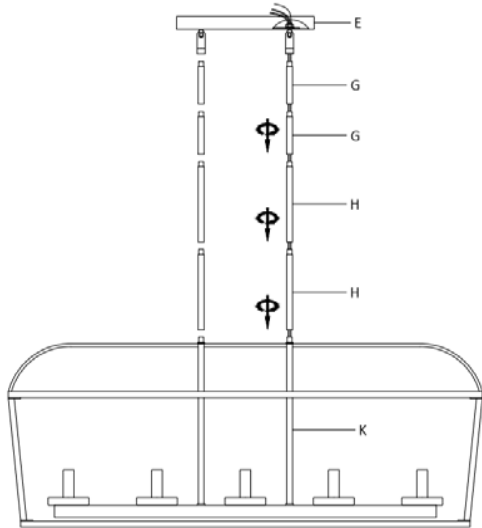

Step 3: Screw the Long Stem (H) and Short Stem (G) to the nipple of the Center Rod (K). Make sure to feed the branchwires of the fixture through the stems during assembly. Remove or add stems to adjust the height. Then screw the swivel of the canopy (E) to the stem. then secure with the hex nut.

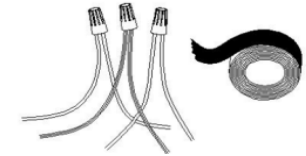
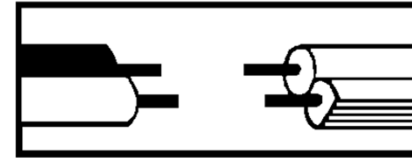

Step 4: wire connection

Connect fixture neutral wire (ribbed) to the outlet box neutral wire (usually white) using a wire connector (A).

Connect fixture hot wire (smooth with markings) to the outlet box hot wire (usually black) using a wire connector (A).

CAUTION: Do not reverse the hot and neutral connections

Grounding Instructions:

Wrap ground wire from outlet box around green ground screw (C) on mounting bracket, no less than 2" from wire end. Tighten ground screw. If fixture is supplied with a ground wire, connect to outlet ground wire with a wire connector (A).

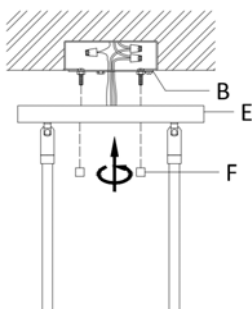

Step 5: Tuck wires inside junction box. Attach the Canopy (E) to the Mounting Plate (B), and secure with the Canopy Nut (F).

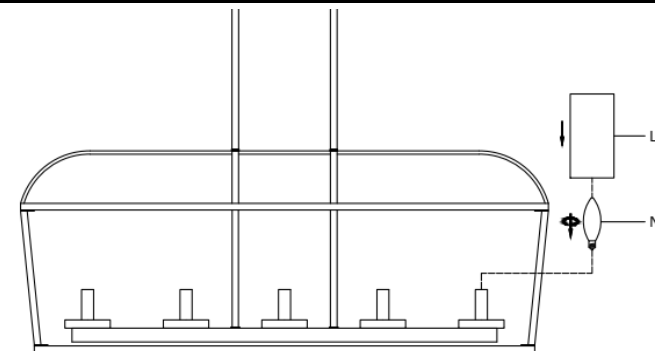

Step 6: Insert the Bulbs (N) into the Socket. Insert Glass (L) to socket cap.