

YZZW-V2

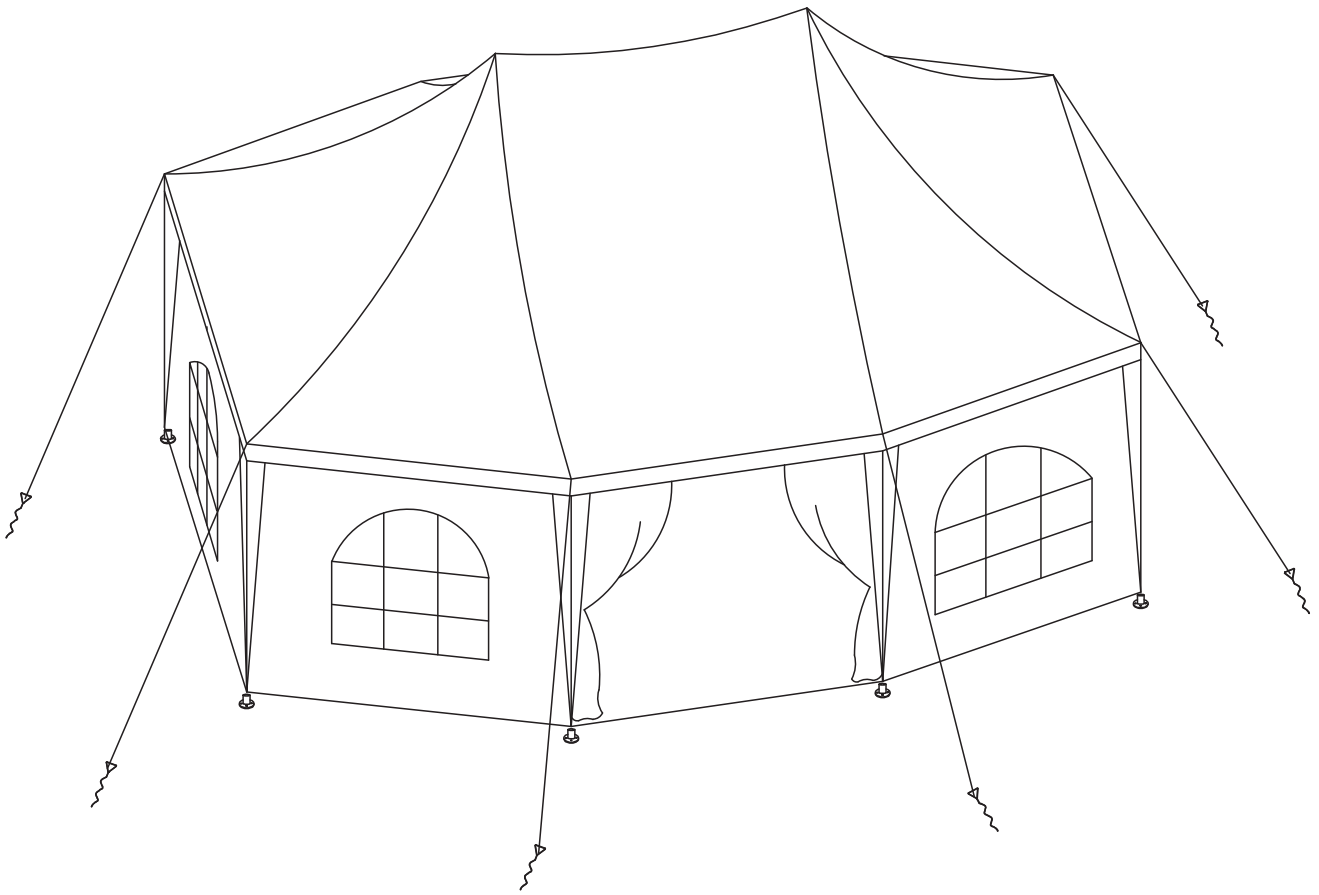

WEDDING TENT

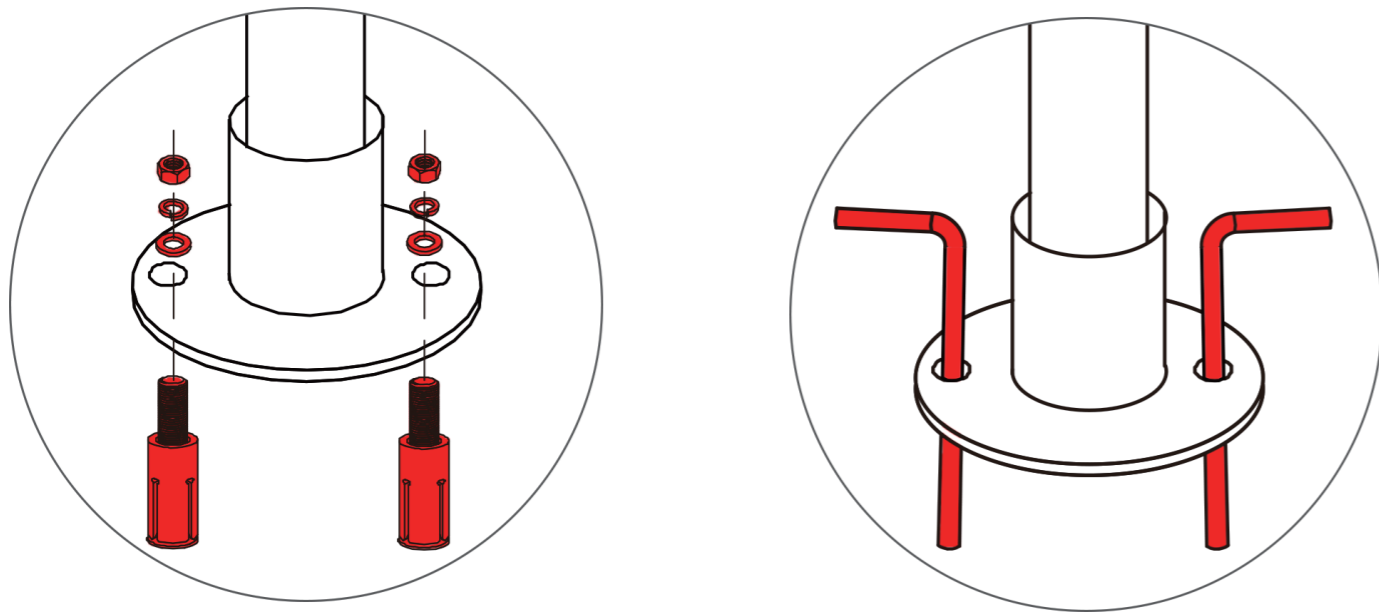

1. Must use ground nails, ropes, and expansions screws for whichever ground you install on for stability to avoid devastating injuries for people inside or nearby and property damage caused by a collapsing gazebo.
2. Do not use this gazebo in high winds, heavy snow, or inclement weather. It is not designed to withstand strong gusts of wind, heavy snow accumulation, or other inclement weather. Must take precautions when the wind speed exceeds 25Mph, and clear snow when it accumulates more than 2 inches.
3. Before use, thoroughly inspect the gazebo to make sure all bolts, nuts, and buckles have been completely tightened and securely fastened.
4. Warranty does not cover damages, losses, or injuries resulting from improper installation, misuse, not using stability accessories mentioned above, non snow cleaning, failure to take precautionary measures, etc.

- !**
1. Three or more people are required for the assembly.
 2. A ladder is recommended during assembly.
 3. Ensure you have all the required parts and organize them before assembling.
 4. An electric drill is recommended for the assembly.
 5. Do not use candles, matches or open flames of any kind inside or near a tent.
 6. Professional installation is highly recommended.

Item no. Nr. N° d'article Articolo No. Artículo No.	Reference Image Referenzbild Image de référence Immagine di riferimento Imagen de referencia	Qty. Menge Qté. Qtà Cant.	Item no. Nr. N° d'article Articolo No. Artículo No.	Reference Image Referenzbild Image de référence Immagine di riferimento Imagen de referencia	Qty. Menge Qté. Qtà Cant.
1		X17	F		X2
2		X8	G		X8
3		X2	H		X16
4		X2	I		X8
A		X2	J		X38
B		X2	K		X1
C		X4	L		X2
D		X8	M		X2
E	 M6 X 45MM	X8	N		X24

1

- ① 8pcs
- A 2pcs
- B 2pcs
- C 4pcs

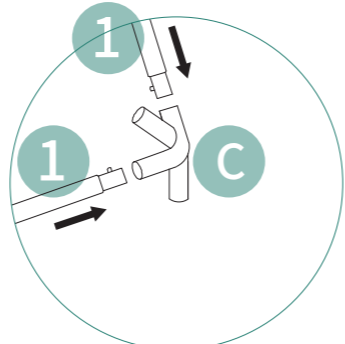
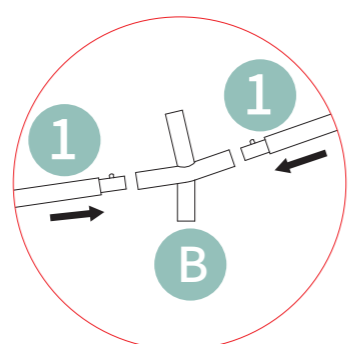
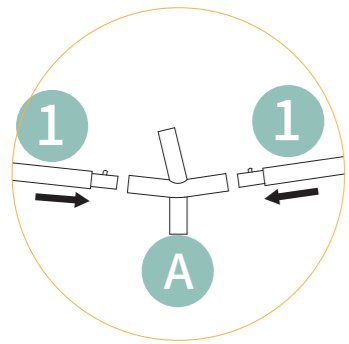
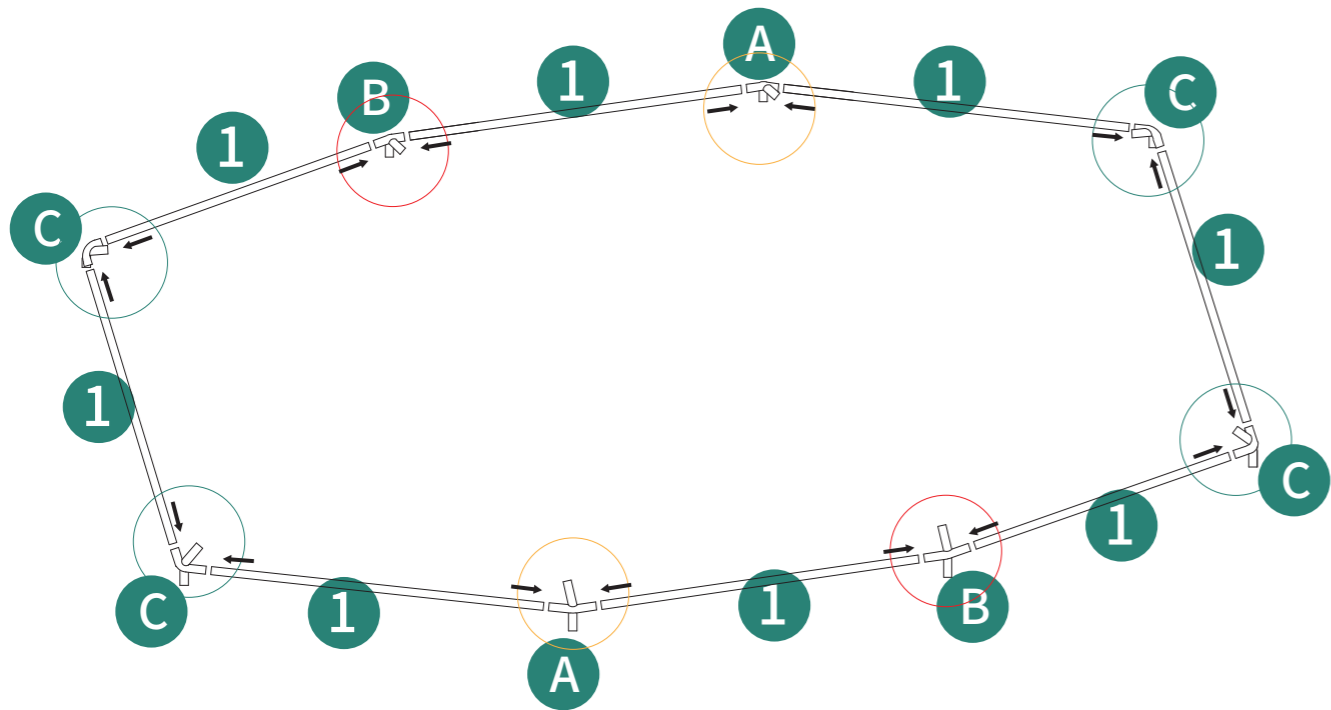

3

2

- ① 9pcs
- ③ 2pcs

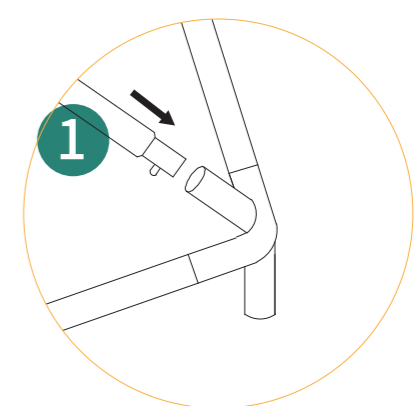
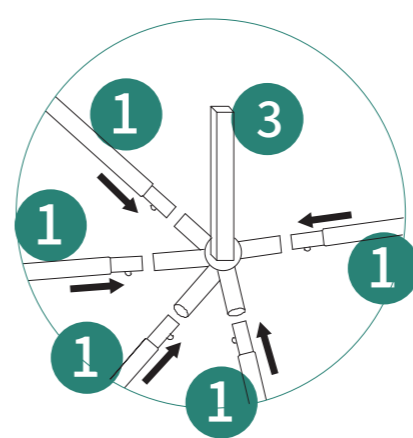
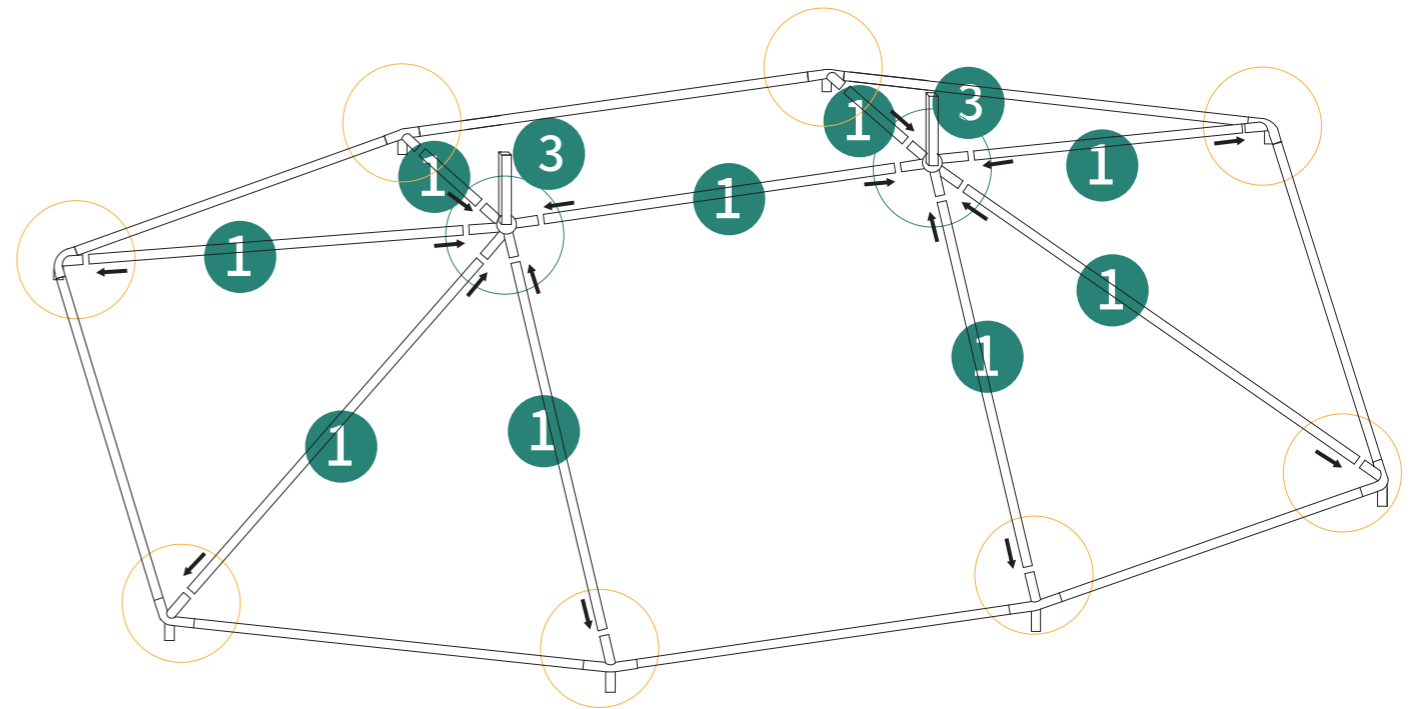

4

3

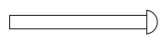

④2pcs



ⓕ2pcs

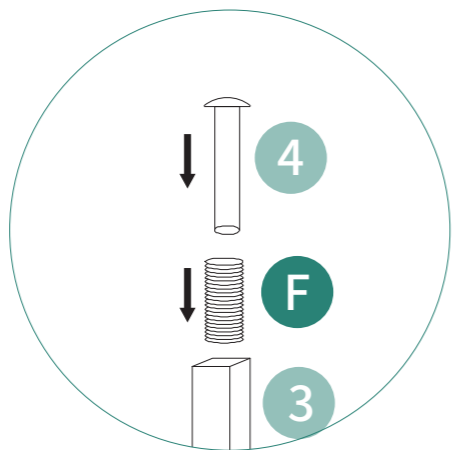
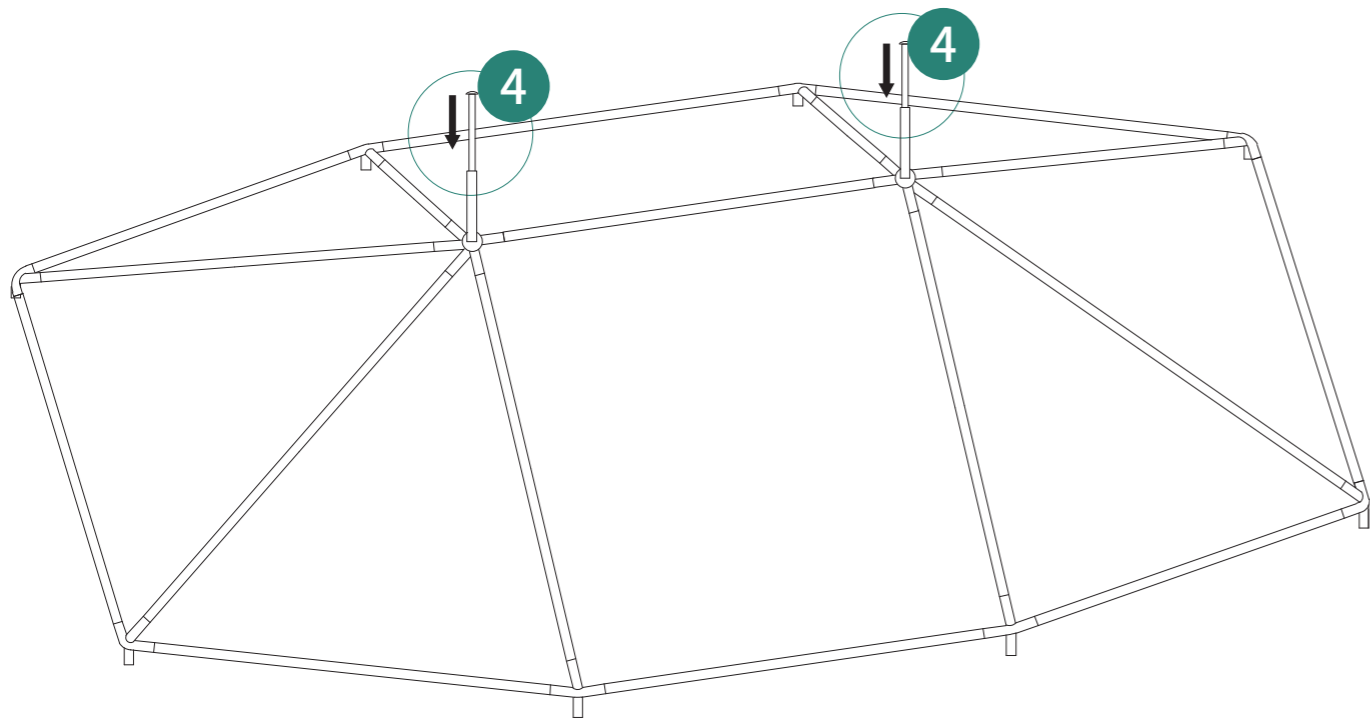

5

4

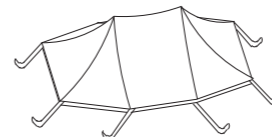

Ⓚ1pc

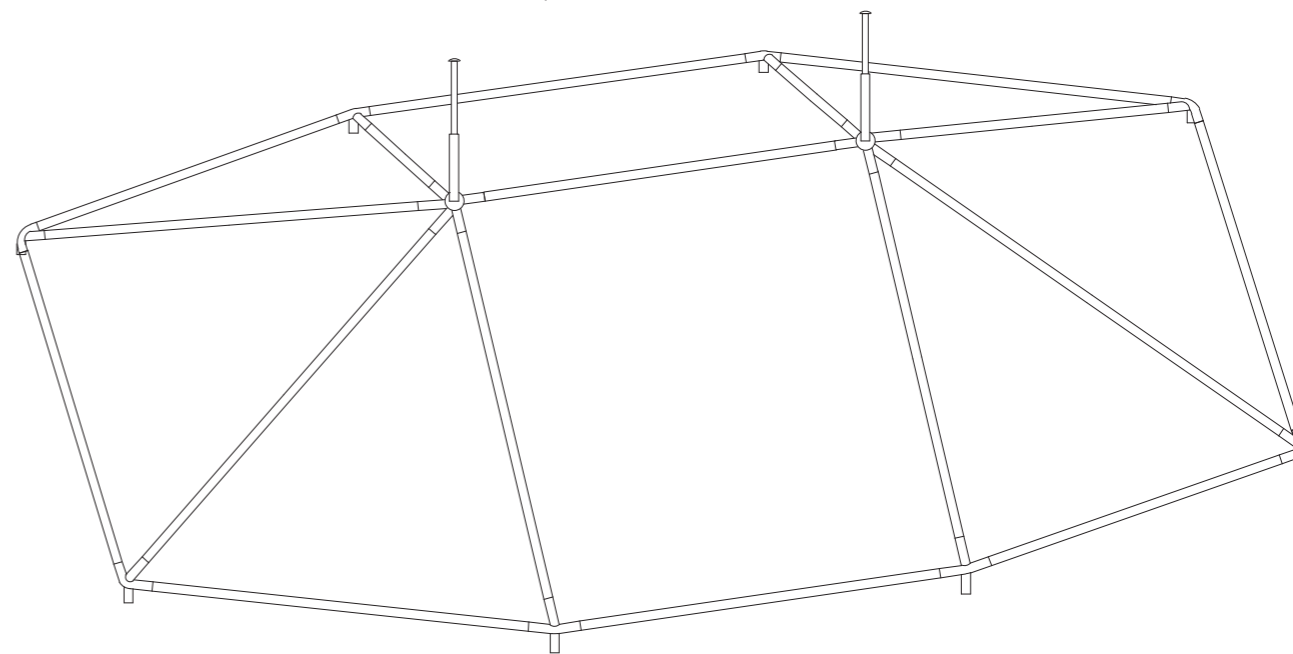
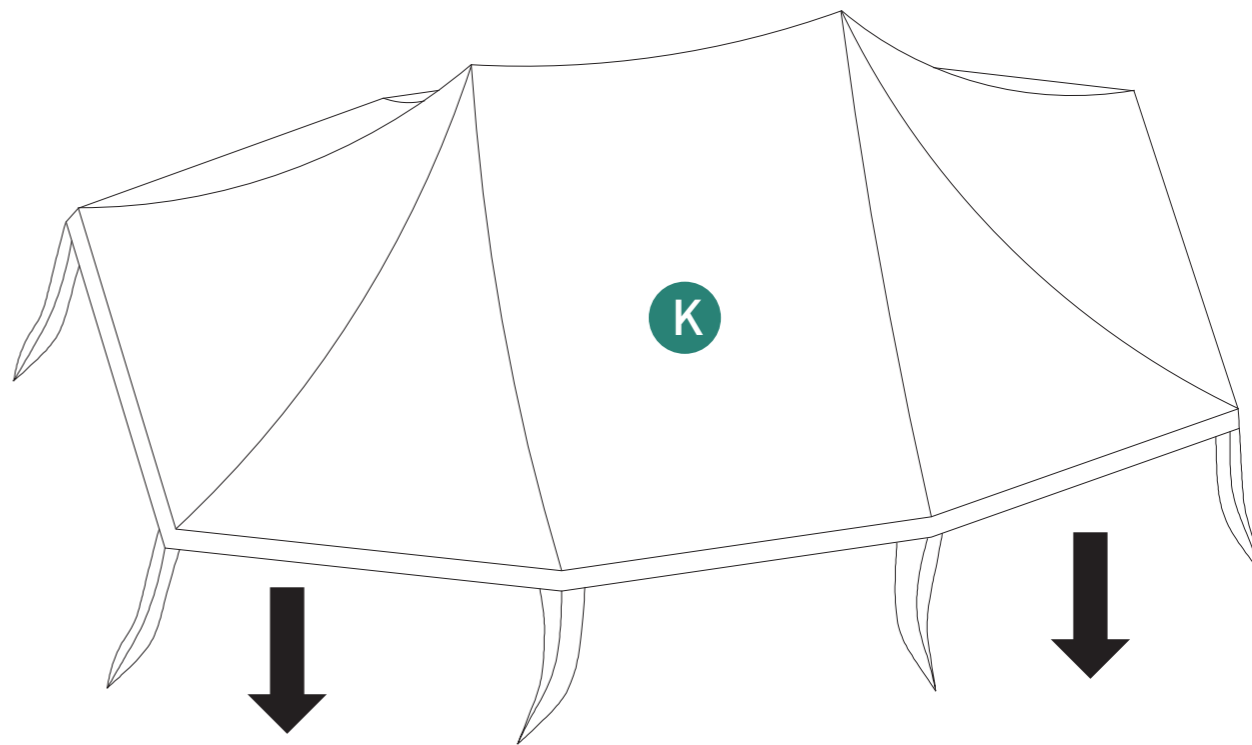

6

5



② 8pcs



④ 8pcs



⑤ 8pcs



⑩ 38pcs

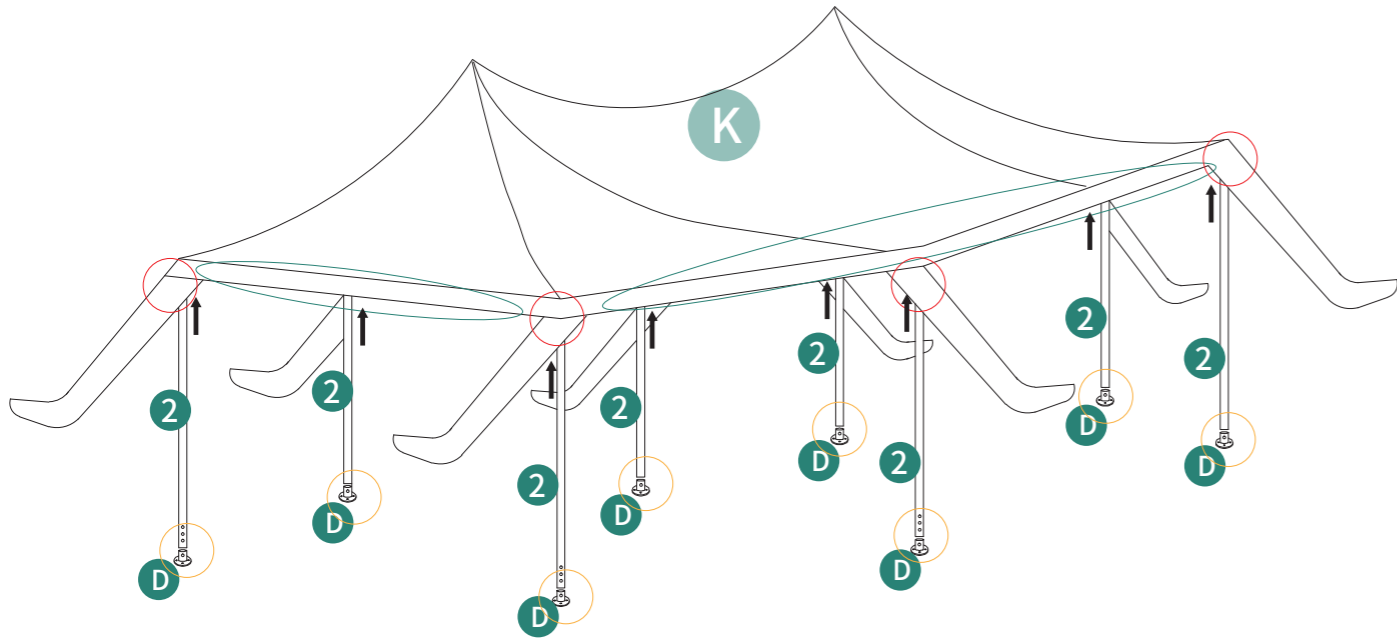

6



⑨ 16pcs

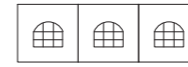

⑬ 2pcs

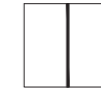

⑭ 2pcs

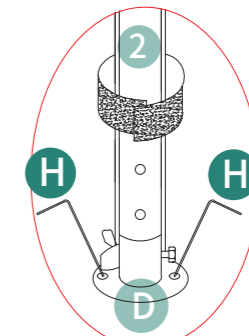
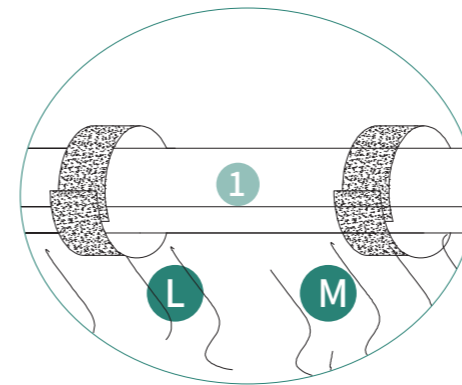
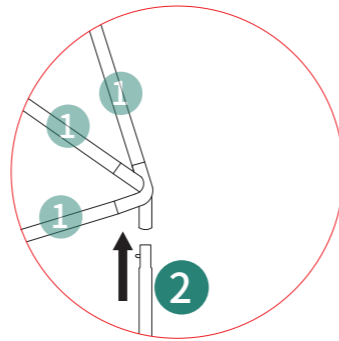
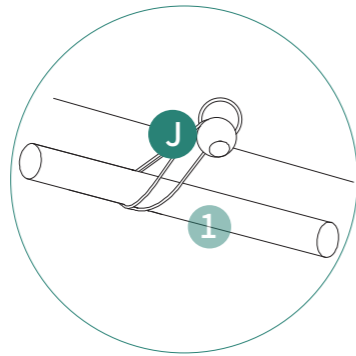
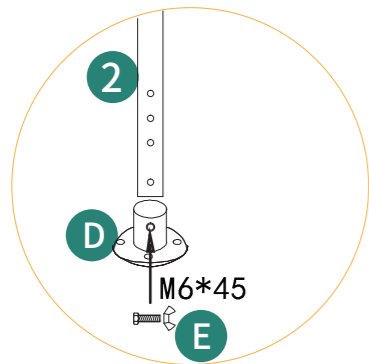
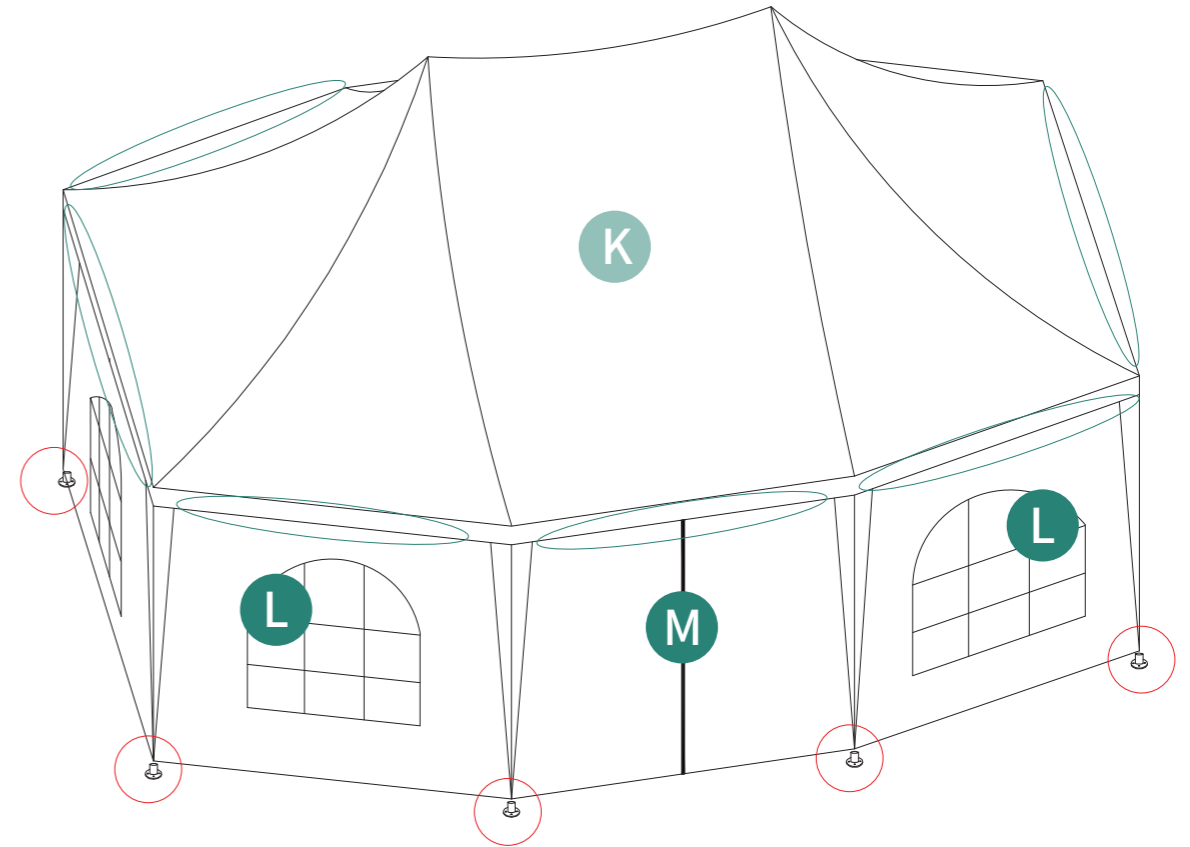

1

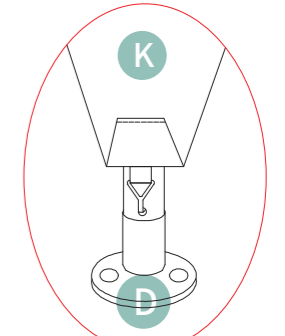

2

7

ⓐ 8pcs

ⓑ 8pcs

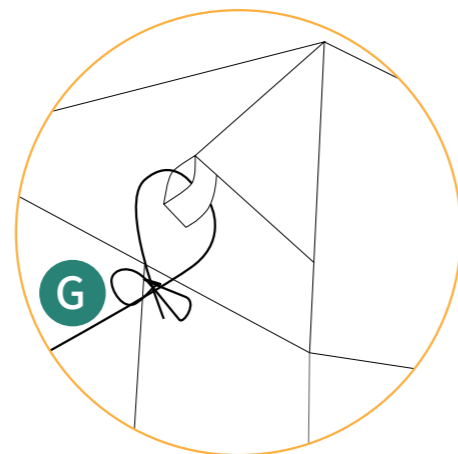
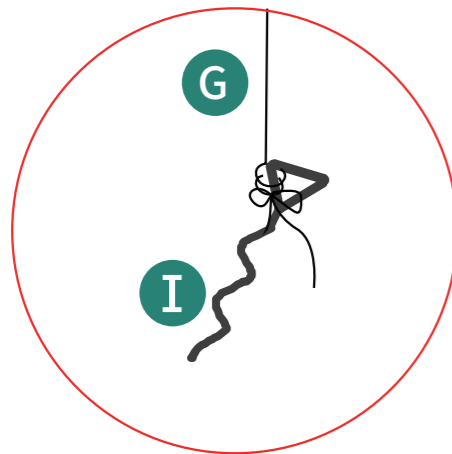
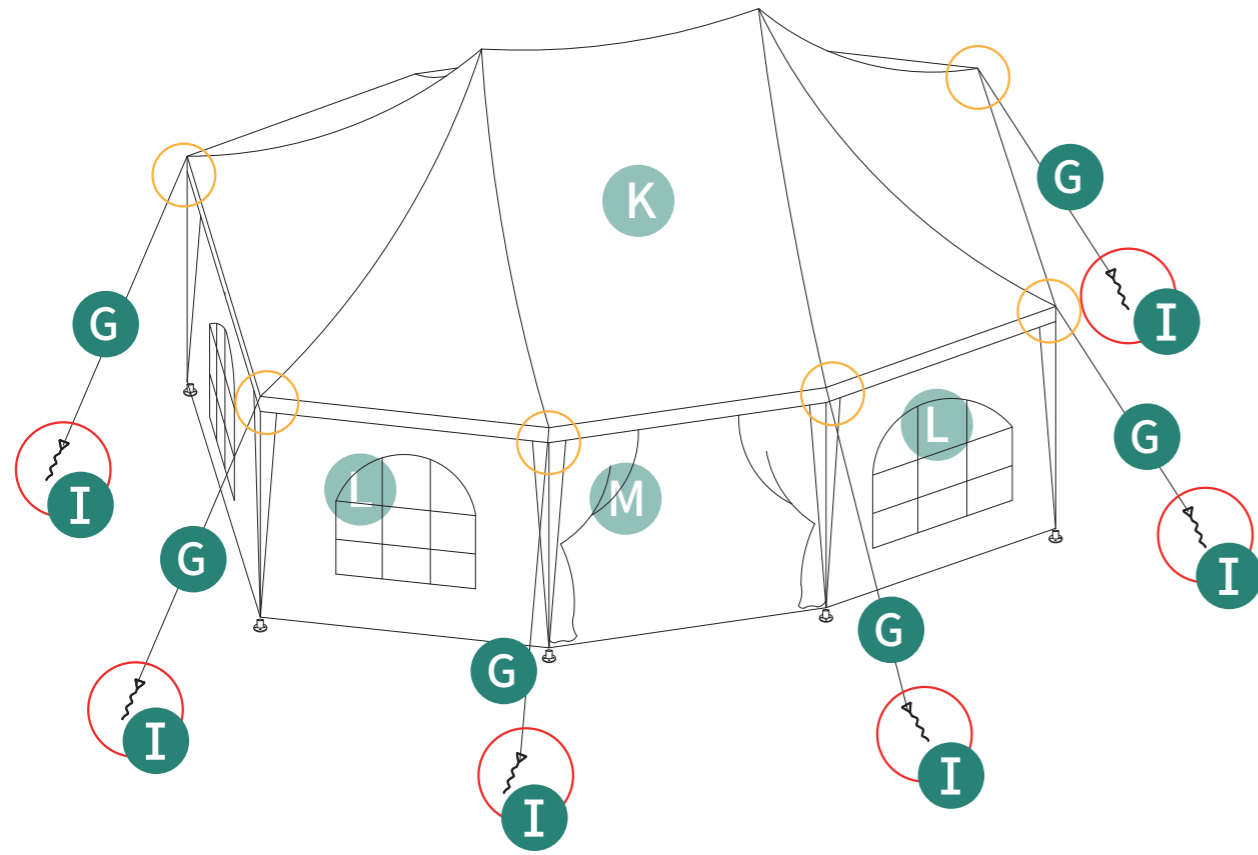

8

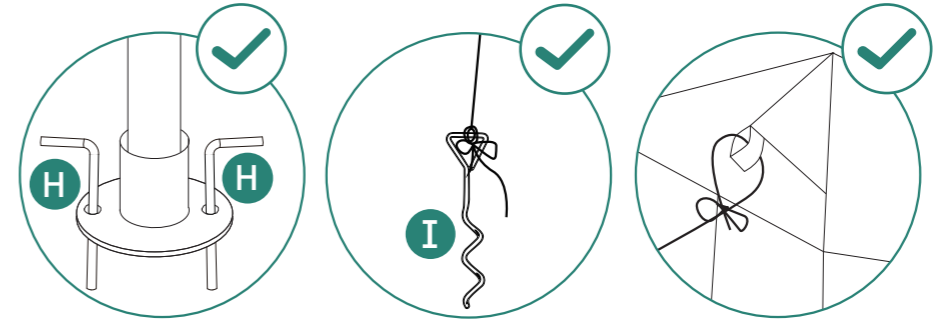

Grassy surfaces

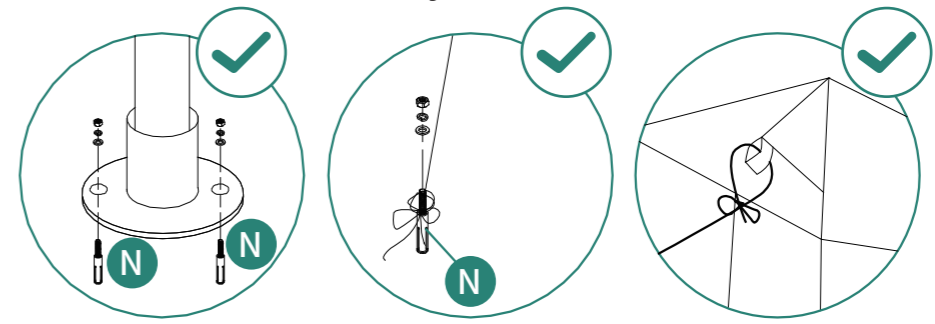

Cement surfaces

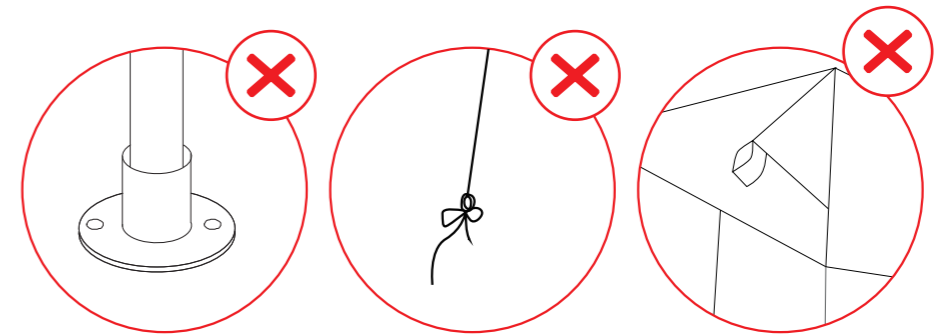

To improve wind resistance, **be sure to complete this installation step. If expansion screws or ground nails are not installed, strong winds may topple the gazebo.**

Expansion screws are essential for stability on cement surfaces, and ground nails are for grassy surfaces.

All are included in the accessories package.

Installation Completed