

INSTALLATION INSTRUCTIONS FOR CENTER OPEN BATON DRAW DOUBLE TRAVERSE ROD

BU

PARTS LIST

1. Inner Rod
2. Outer Rod
3. Brackets
4. Carriers
5. Overlap Master Carrier
6. Under Master Carrier
7. End Caps
8. Batons
9. Screw and dry wall anchor

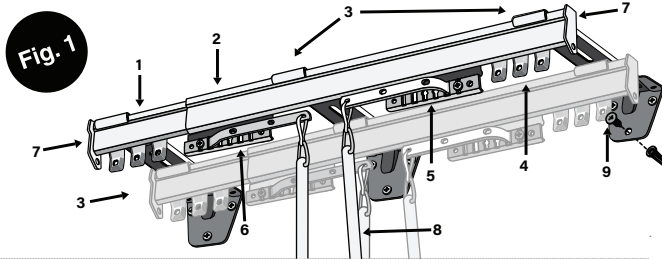

1

OPTIONAL: ASSEMBLE THE RODS (ONLY FOR RODS WITH 3 SECTIONS)

Remove the end cap of the outer rods by unscrewing the screw securing it. Insert the inner rod into the outer rod.

IMPORTANT: Make sure to keep at least 3.5 inches of overlap between each joint of the inner rod and outer rod.

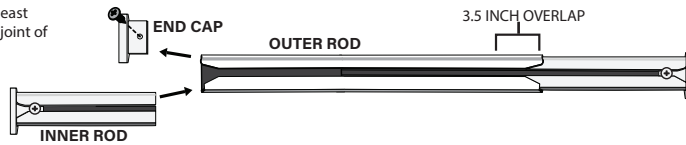

2

OPTIONAL: CONVERT TO LEFT-ONE WAY TRAVERSE

Remove left end cap, remove carriers, followed by both master carriers.

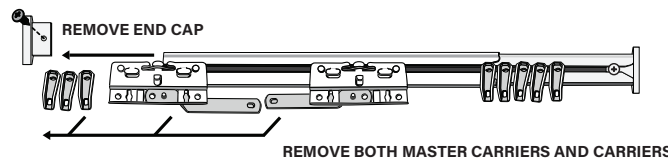

Replace the number of carriers required for your curtain, followed by left master carrier and then the end cap.

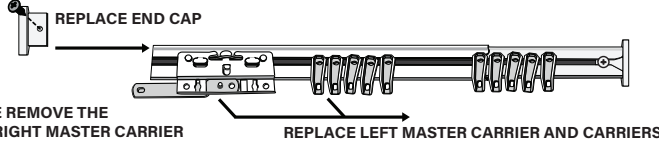

FOR RIGHT-ONE WAY TRAVERSE REMOVE THE RIGHT END CAP AND REPLACE RIGHT MASTER CARRIER

REPLACE LEFT MASTER CARRIER AND CARRIERS

3

MOUNTING INSTRUCTIONS:
Wall mount option- Mount the two end brackets to the wall at the desired location. No center bracket is needed for installations less than 50" long.

FOR RODS FULLY EXTENDED TO 50" OR MORE, INSTALL THE CENTER BRACKET.

DOUBLE BRACKETS

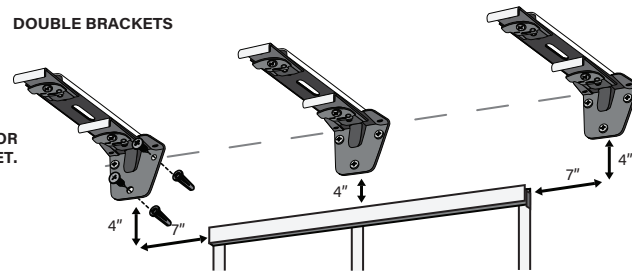

OPTIONAL: CEILING INSTALLATION. If rod is to be installed on the ceiling, detach the wall mount part of the brackets from the ceiling mount portion. Attach the ceiling brackets directly to ceiling.

Wall Mount Bracket

Ceiling Mount Bracket

Adjustment Screw

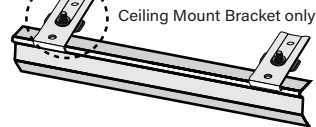
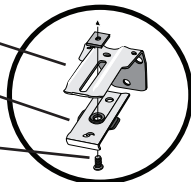

4

ADJUST THE PROJECTION AND ATTACH ROD TO THE BRACKETS

Projection may be adjusted by loosening adjusting screws.

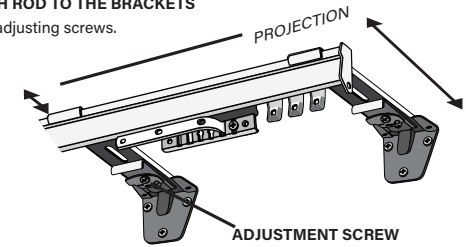

ATTACH THE ROD

The support arm goes over the top of the rod with the silver cam lock toward the floor. The rod fits into the arm hook and locks in by turning the cam lock with a flat screwdriver. Do not turn the Philips screw.

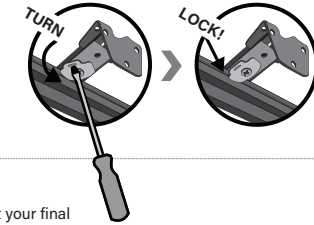

5

ATTACH THE CURTAINS TO THE ROD

Hang the curtains and wrap around the rod's end to put your final drapery pin through the hole on the end caps

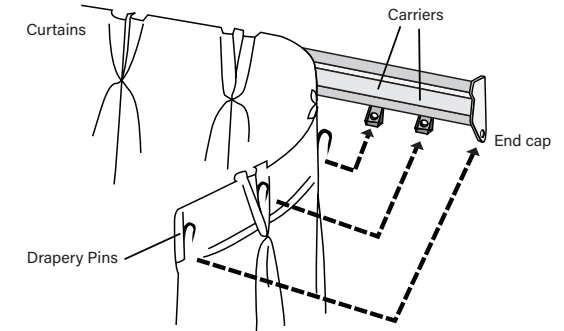

6

ATTACH THE BATONS TO THE ROD

Attach each baton's clip to the first hole on both master carriers' arms.

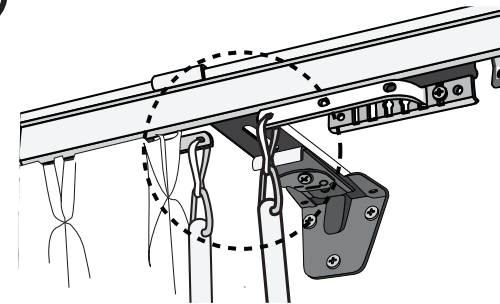

Use the batons to draw the curtains.

