

# Generation 2.0 Parts List (with upgraded design & parts)

## Link Group

### A Group: Support Poles

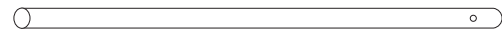

### B Group: Rim Parts

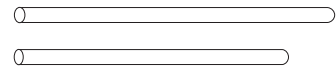

### C Group: Bow Parts

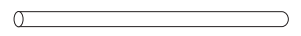

## Hardware



Bolts:  
Size M6 x 35

## Tools



LW L Wrench

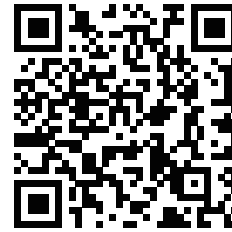

More assembly videos!

## Mesh Cover

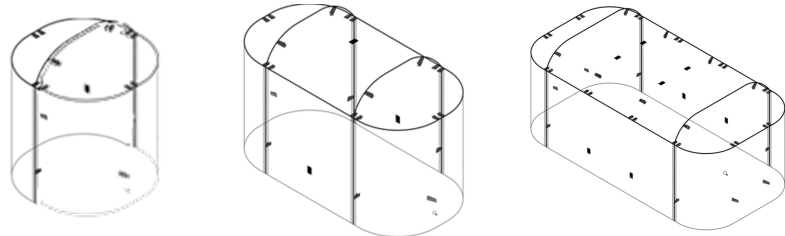

(Note: This manual is designed for all Vego Garden Cover Systems, and the variety of parts & quantity will vary depending on the model that was purchased.)

# Assembly Guide

[www.vegogarden.com/assembly](http://www.vegogarden.com/assembly)

## 1 Step 1: Attach Support Poles

Place the Support Poles (A) on the inside of the garden bed, aligned with the top-most, pre-drilled holes. Before attaching, push a Support Pole Plug into the bottom of each Support Pole.

Insert a bolt through the garden bed, Support Pole and both layers of the Support Pole Plug from the outside of the bed as shown. On the inside of the garden bed, use a flange cap nut to secure the pole.

Firmly push the Tee Fittings & Cross Fittings onto the top of each Support Pole, with the arms of the Tee Fittings parallel to the edges of the garden bed.

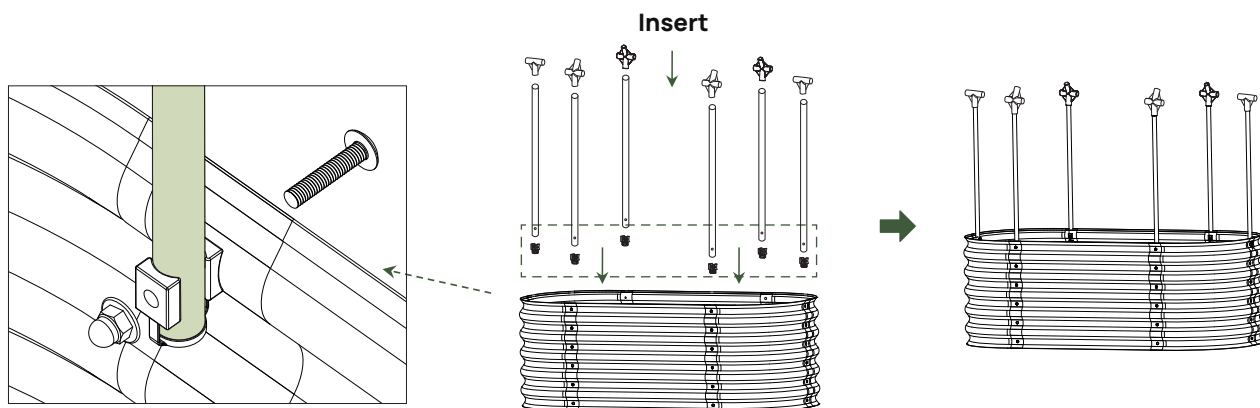

## 2 Step 2: Create the Rim

Insert the B Group Parts firmly into the arms of each Tee Fitting to create the Rim. Push the pieces together until the indentation in the pole aligns with the edge of the fitting.

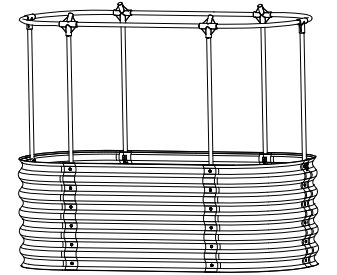
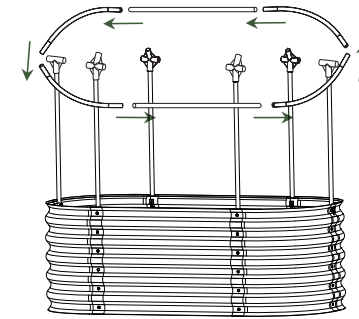
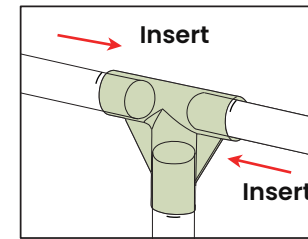

## 3 Step 3: Create the Bows

Connect the C Group parts to form bows using the included Weatherproof Joint Tubes (JT.) Connect the bows using this tube instead of hardware to prevent moisture from entering the interior of the frame. Repeat this for each bow.

Note: Ensure the small indentation in the Weatherproof Joint Tube is facing upwards.

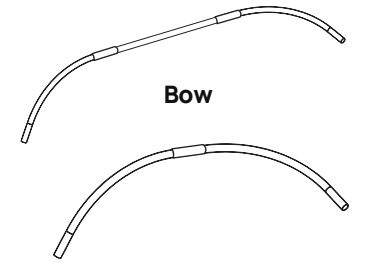
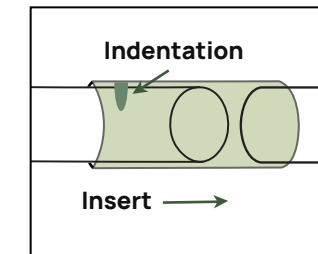
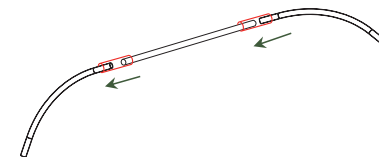

## 4 Step 4: Build the Frame

To connect the Bows, Rim, and Support Poles push all the pieces firmly into the weatherproof cross fittings as shown, noting that one leg of the cross is wider than the others, and the wider leg should point downwards.

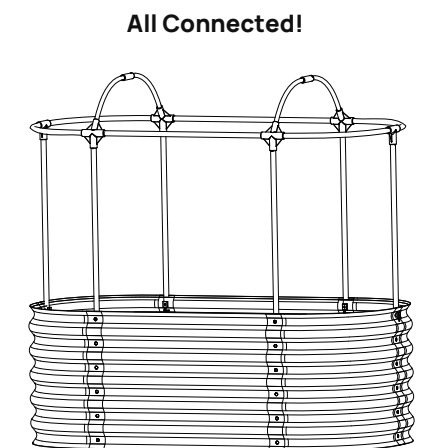
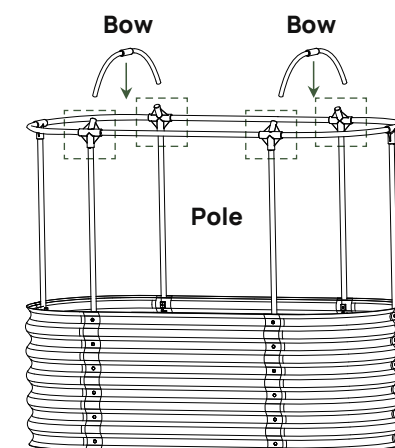
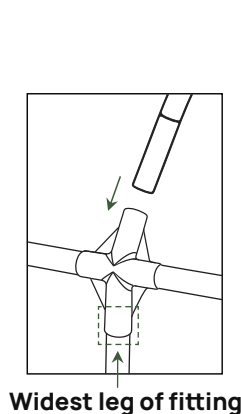

## Assembly Guide

### 5 Step 5: Install Mister Irrigation System

If you are installing a Mister Irrigation System, please refer to the Mister Irrigation System Manual included with the product.

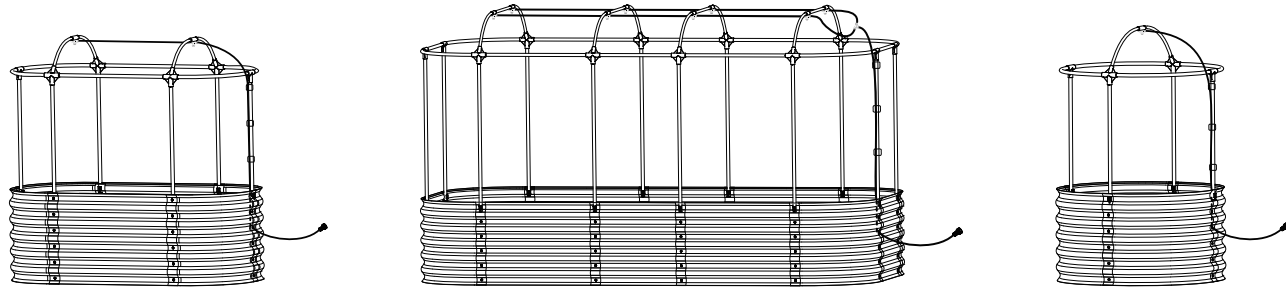

### 6 Step 6: Attach the Cover

Place the mesh cover over the frame & tighten the Velcro. Congratulations on assembling the Cover System!

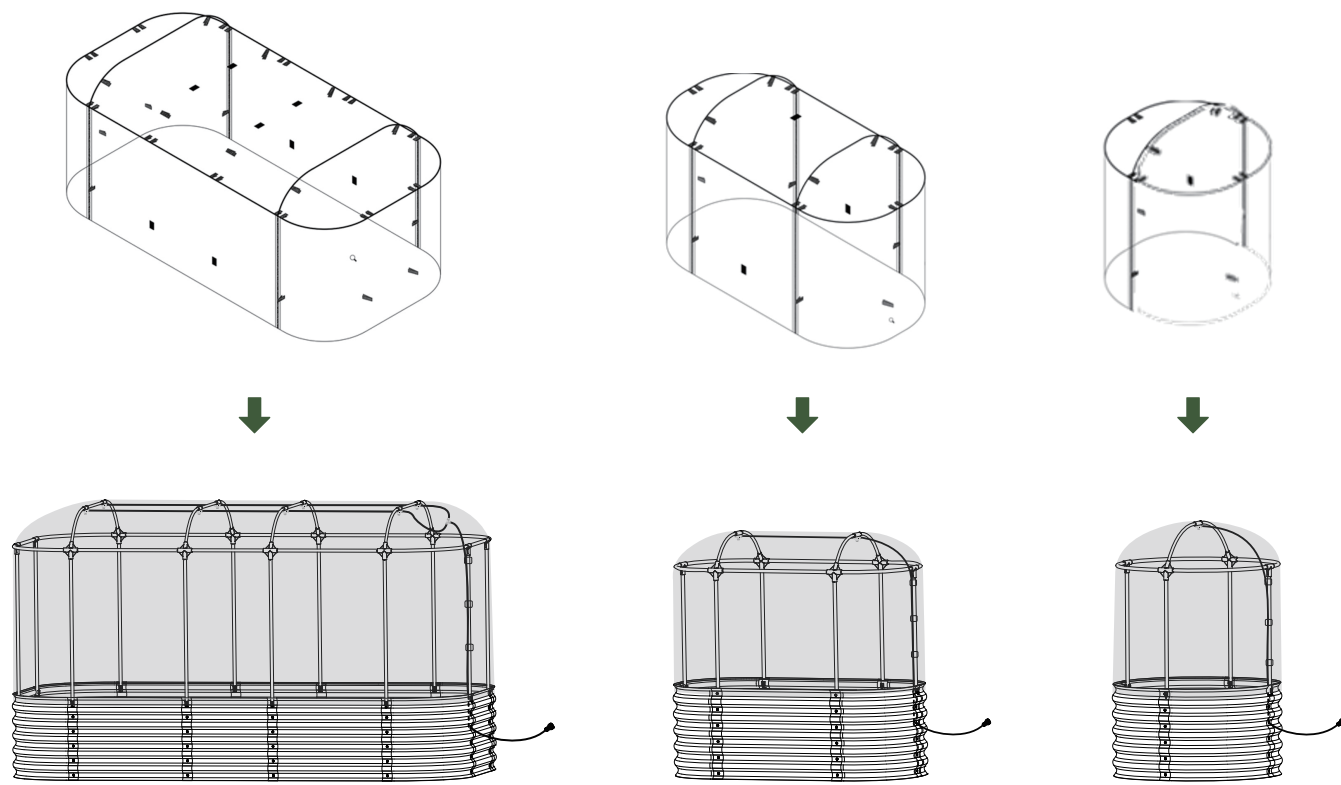

# General Manual for Garden Bed Cover Systems

Gen 2 with upgraded design & parts

(Note: This manual is designed for all Vegö Garden Cover Systems, and the variety of parts & quantity will vary depending on the model that was purchased.)

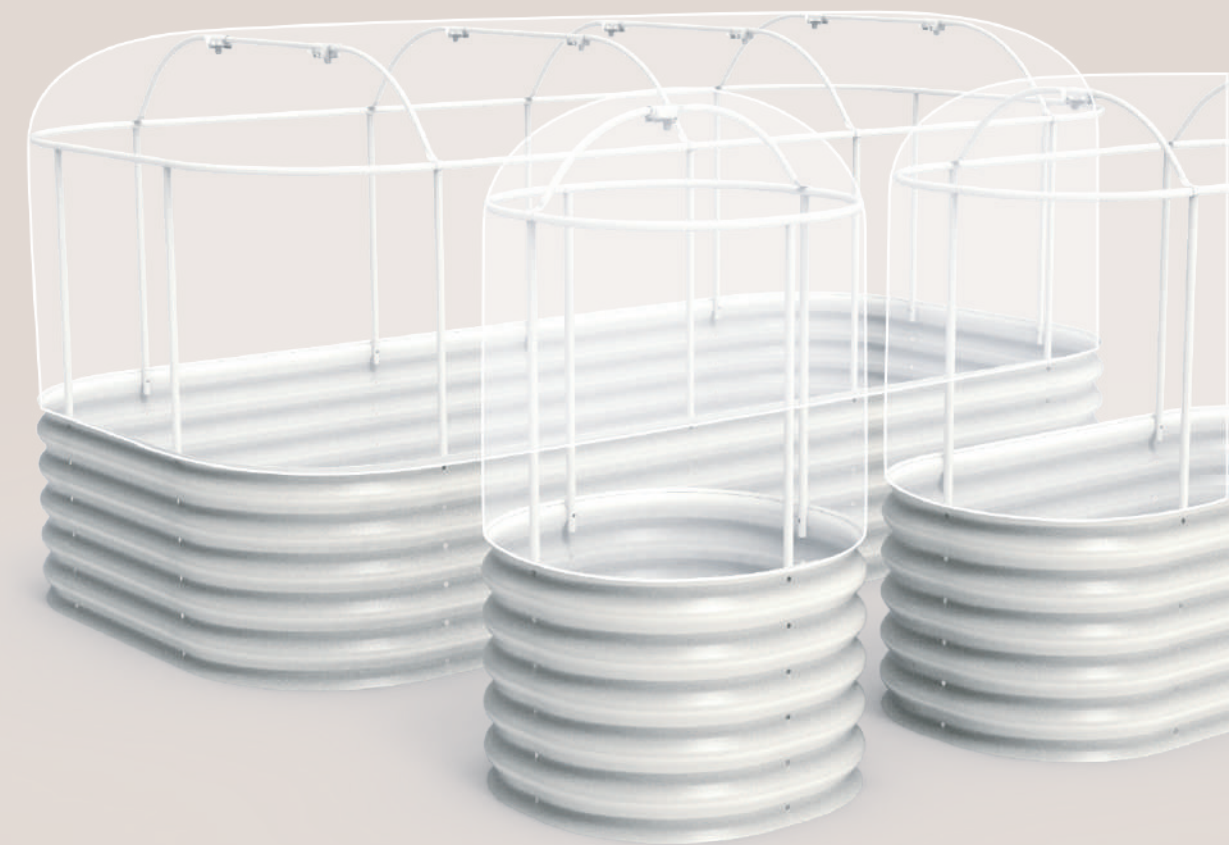

## Contact Us

+1 (866) 597-1888

hello@vegogarden.com

www.vegogarden.com

Houston, TX 77023

vegö\_garden

Vegö Garden-Raised Beds

**CAUTION:** Please be aware the metal panels may have sharp edges that could cause injury. The use of protective equipment such as gloves and closed toe shoes is recommended.

**CHOKING HAZARD:** Small parts. Keep product away from children.

V3.0 12/04/2024