

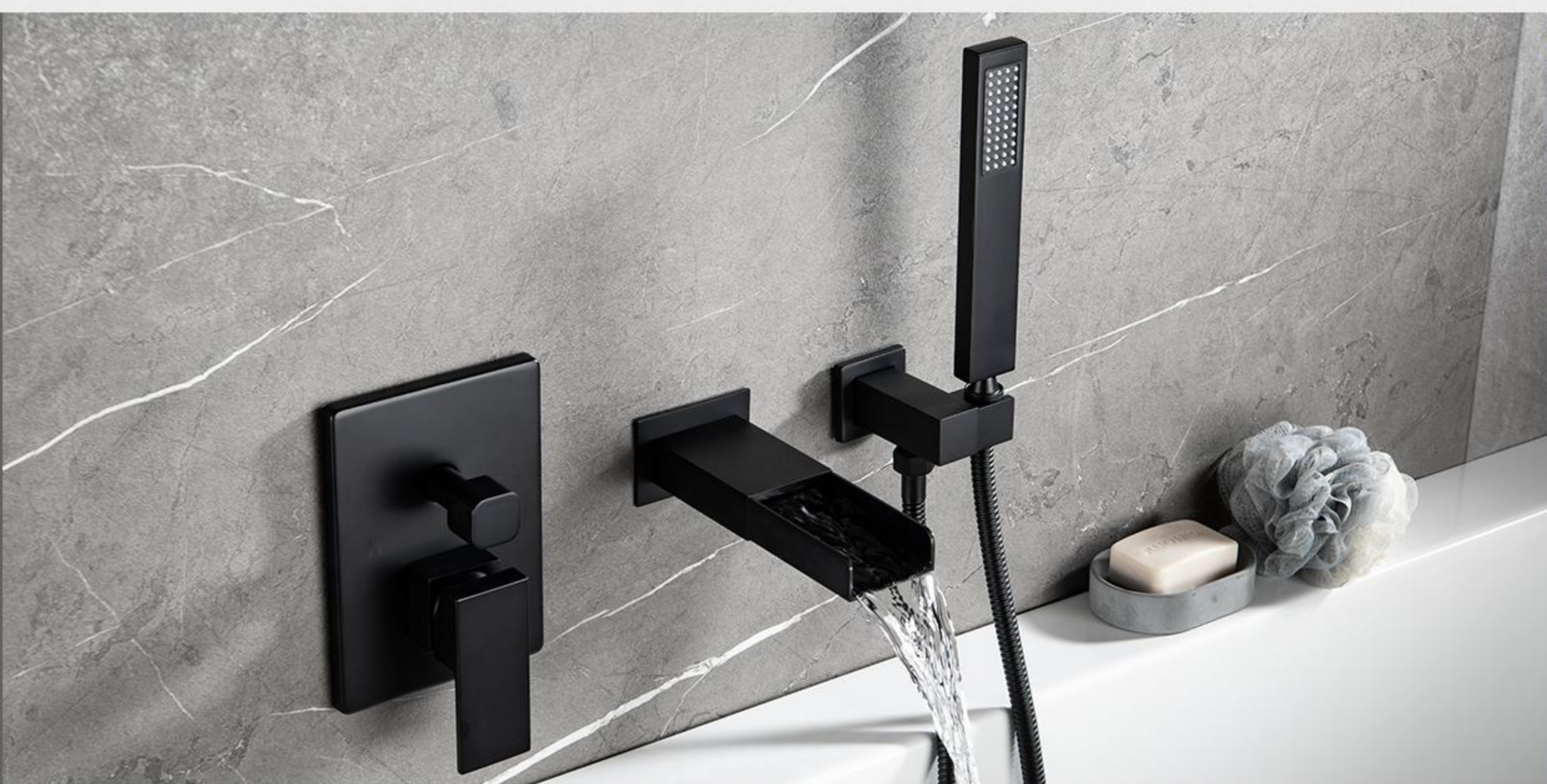

User's Manual



INSTALLATION INSTRUCTIONS

Installation Manual

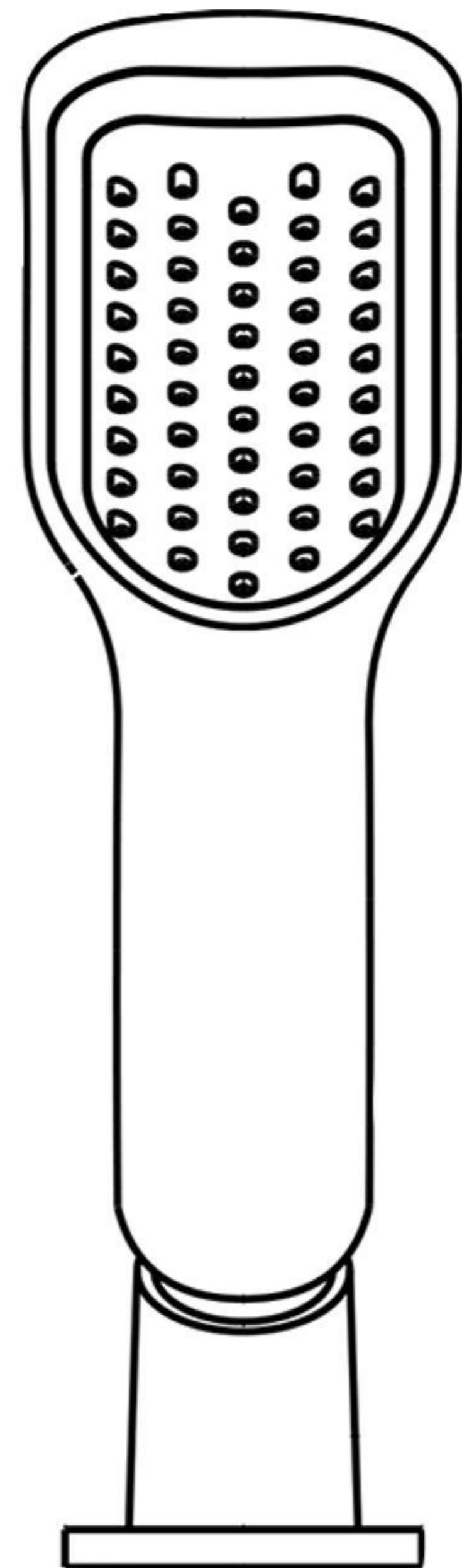
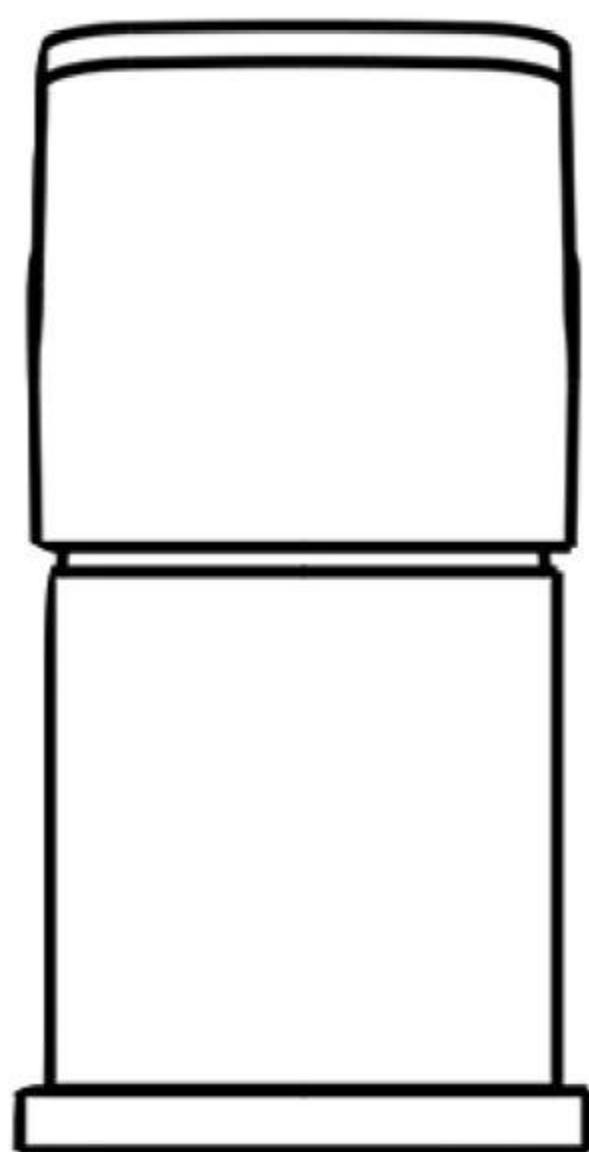

RB0746

IAPMO RESEARCH AND TESTING, INC.
5001 East Philadelphia Street, Ontario, California 91761-2816 • (909) 472-4100 Fax (909) 472-4244 • www.iapmo.org

CERTIFICATE OF LISTING

 IAPMO Research and Testing, Inc. is a product certification body which tests and inspects samples taken from the supplier's stock or from the market or a combination of both to verify compliance to the requirements of applicable codes and standards. This activity is coupled with periodic surveillance of the supplier's factory and warehouses as well as the assessment of the supplier's Quality Assurance System. This listing is subject to the conditions set forth in the characteristics below and is not to be construed as any recommendation, assurance or guarantee by IAPMO Research and Testing, Inc. of the product acceptance by Authorities Having Jurisdiction.

Effective Date: August 2013 Void After: August 2014

Product: Plumbing Fixture Fittings File No. 8737

Issued To: Kaiping Heart Cartridge Co., Ltd.
No. 28 Weihuan Dong Road,
Shuilou Town,
Kaiping City, GUANDONG
China

Identification: Plumbing supply fittings complying with this Standard shall be marked with the manufacturer's recognized name, trademark, or other mark or, in the case of private labeling, the name, trademark or other mark of the customer for whom the fitting was manufactured. The marking shall be accomplished by use of a permanent mark or by placing a permanent label on the product. Markings on plumbing supply fittings shall be visible after installation.

Single-handle, single-control, and automatic compensating mixing bath and shower valves shall have identifiable temperature control settings in which the settings are indicated by words ("cold", "warm", "hot", etc.), by numbers, or graphically.



Packages shall be marked with the manufacturer's name, trademark, or other mark as well as the model number or, in the case of private labeling, the name, trademark, or mark of the customer for whom the fitting was manufactured as well as the model number.

David McHenry, Chairman, Product Certification Committee Ren Chaney, CEO, The IAPMO Group

This listing period is based upon the last date of the month indicated on the Effective Date and Void After Date shown above. Any change in material, manufacturing process, marking or design without having first obtained the approval of the Product Certification Committee, or any evidence of non-compliance with applicable codes and standards, or of inferior workmanship, may be deemed sufficient cause for revocation of this listing. Production of or reference to this form for advertising purposes may be made only by specific written permission of IAPMO Research and Testing, Inc. Any alteration of this certificate could be grounds for revocation of the listing.

IAPMO RESEARCH AND TESTING, INC.
5001 East Philadelphia Street, Ontario, California 91761-2816 • (909) 472-4100 Fax (909) 472-4244 • www.iapmo.org

CERTIFICATE OF LISTING

 IAPMO Research and Testing, Inc. is a product certification body which tests and inspects samples taken from the supplier's stock or from the market or a combination of both to verify compliance to the requirements of applicable codes and standards. This activity is coupled with periodic surveillance of the supplier's factory and warehouses as well as the assessment of the supplier's Quality Assurance System. This listing is subject to the conditions set forth in the characteristics below and is not to be construed as any recommendation, assurance or guarantee by IAPMO Research and Testing, Inc. of the product acceptance by Authorities Having Jurisdiction.

The most updated information on this Certificate of Listing is available online at pfd.iapmo.org

Effective Date: October 2016 -Rev. 11/28/2016- Void After: October 2017

Product: Flexible Water Connectors File No. 4955



Issued To: Yuhuan Jianglin Plumbing Hose & Parts Co., Ltd.
Package Industry Zone
Yuhuan County
Zhejiang 317600,
China

Identification: Manufacturer's name or trademark and cUPC® certification mark. Special note on label "For use with water in exposed locations only."

Characteristics: Flexible water connectors manufactured in various sizes, lengths and metal end fittings for hot or cold water applications that consist of an inner tube, which may or may not have an outer braided cover. Connectors are to be installed for use in accessible locations only and in accordance with the manufacturer's instruction, and the latest edition of the Uniform Plumbing Code.

Products listed on this certificate have been tested by an IAPMO R&T recognized laboratory. This recognition has been granted based upon the laboratory's compliance to the applicable requirements of ISO/IEC 17025.

Products are in compliance with the following code(s):
Uniform Plumbing Code (UPC®)

David McHenry, Chairman, Product Certification Committee Ren Chaney, CEO, The IAPMO Group

This listing period is based upon the last date of the month indicated on the Effective Date and Void After Date shown above. Any change in material, manufacturing process, marking or design without having first obtained the approval of the Product Certification Committee, or any evidence of non-compliance with applicable codes and standards, or of inferior workmanship, may be deemed sufficient cause for revocation of this listing. Production of or reference to this form for advertising purposes may be made only by specific written permission of IAPMO Research and Testing, Inc. Any alteration of this certificate could be grounds for revocation of the listing. This document shall be reproduced in its entirety.

IAPMO RESEARCH AND TESTING, INC.
5001 East Philadelphia Street, Ontario, California 91761-2816 • USA • 909-472-4100 • 909-472-4244 • www.iapmo.org

CERTIFICATE OF LISTING

 IAPMO Research and Testing, Inc. is a product certification body which tests and inspects samples taken from the supplier's stock or from the market or a combination of both to verify compliance to the requirements of applicable codes and standards. This activity is coupled with periodic surveillance of the supplier's factory and warehouses as well as the assessment of the supplier's Quality Assurance System. This listing is subject to the conditions set forth in the characteristics below and is not to be construed as any recommendation, assurance or guarantee by IAPMO Research and Testing, Inc. of the product acceptance by Authorities Having Jurisdiction.

The most updated information on this Certificate of Listing is available online at pfd.iapmo.org

Effective Date: November 2016 -Rev. 3/1/2017- Void After: November 2017

Product: Plumbing Fixture Fittings File No. 4528

Issued To: Neoperl Inc.
171 Mattatuck Heights
Waterbury, CT 06705

Identification: Each fitting component shall bear permanent legible markings to identify the manufacturer. This marking shall be the trade name, trademark, or other mark known to identify the manufacturer. The product shall also bear all other markings required by the standard. The marking shall be located where it can be readily seen after installation is complete. The product or packaging shall also bear the cUPC® certification mark.

Characteristics: Plumbing fixture fitting components to be installed in accordance with the manufacturer's instructions and the requirements of the latest edition of the Uniform Plumbing Code.

Products listed on this certificate have been tested by an IAPMO R&T recognized laboratory. This recognition has been granted based upon the laboratory's compliance to the applicable requirements of ISO/IEC 17025.

Products are in compliance with the following code(s):
Uniform Plumbing Code (UPC®)
National Plumbing Code of Canada

  

Tom Collins, Chairman, Product Certification Committee Ren Chaney, CEO, The IAPMO Group

This listing period is based upon the last date of the month indicated on the Effective Date and Void After Date shown above. Any change in material, manufacturing process, marking or design without having first obtained the approval of the Product Certification Committee, or any evidence of non-compliance with applicable codes and standards, or of inferior workmanship, may be deemed sufficient cause for revocation of this listing. Production of or reference to this form for advertising purposes may be made only by specific written permission of IAPMO Research and Testing, Inc. Any alteration of this certificate could be grounds for revocation of the listing. This document shall be reproduced in its entirety.

BEFORE INSTALLATION

This product has been inspected and debugged by the factory to the best condition. Please do not disassemble and assemble it yourself.

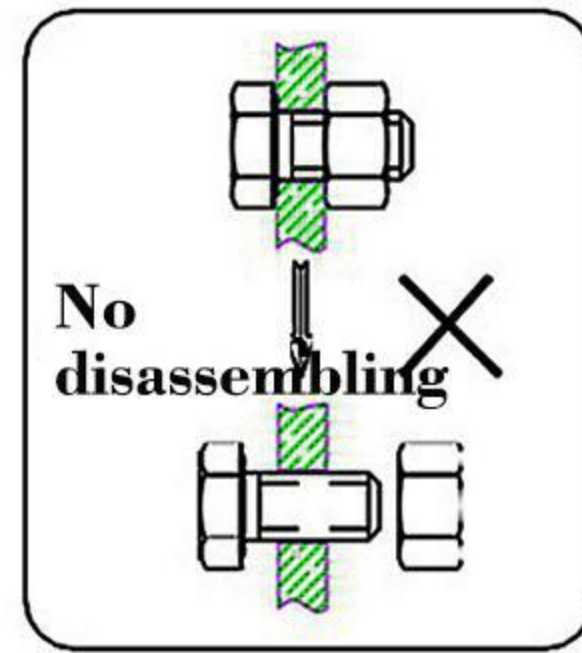

Before installing the faucet, please be sure to remove sundries and sludge from the water pipe to prevent sundries from blocking the faucet.

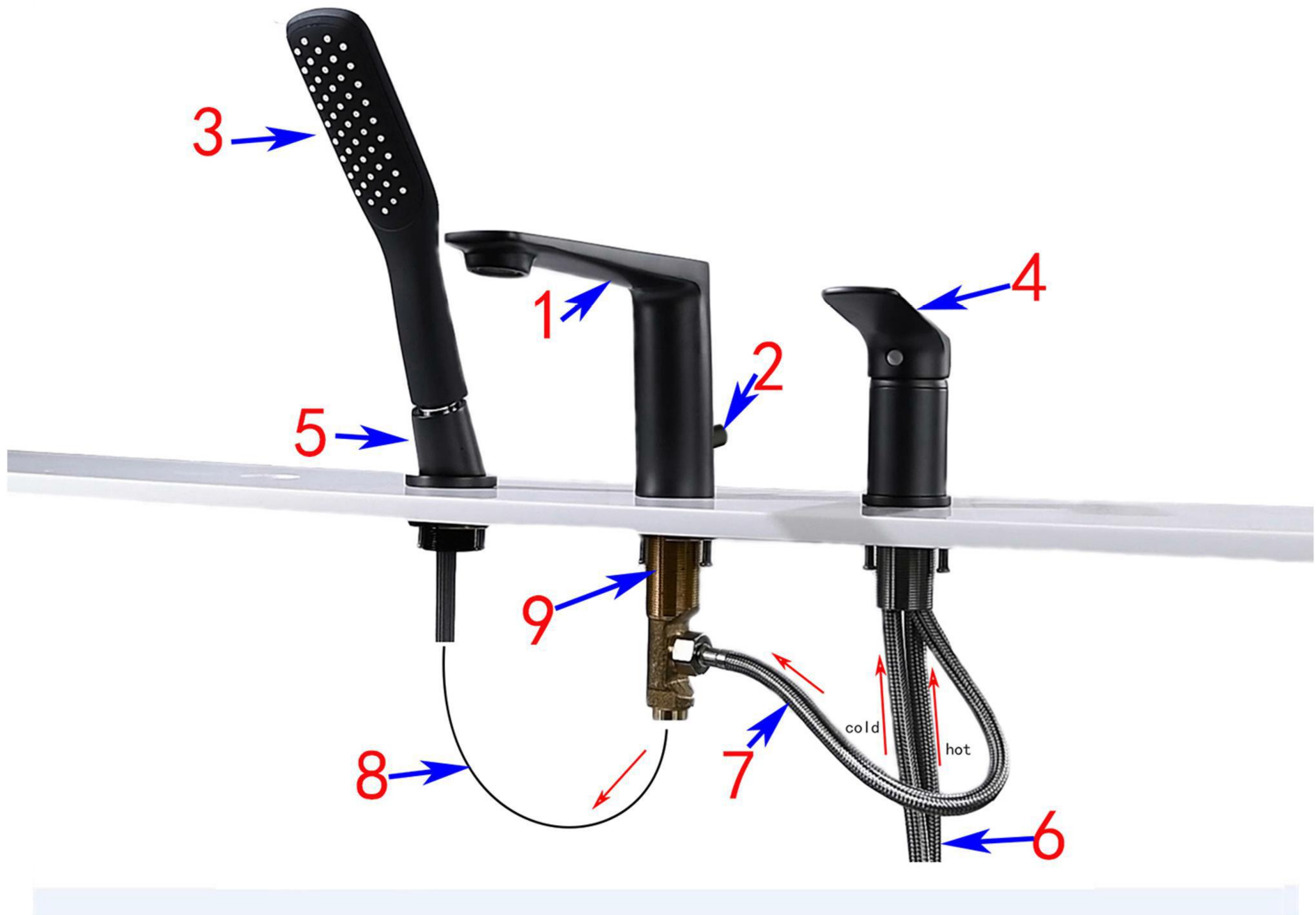
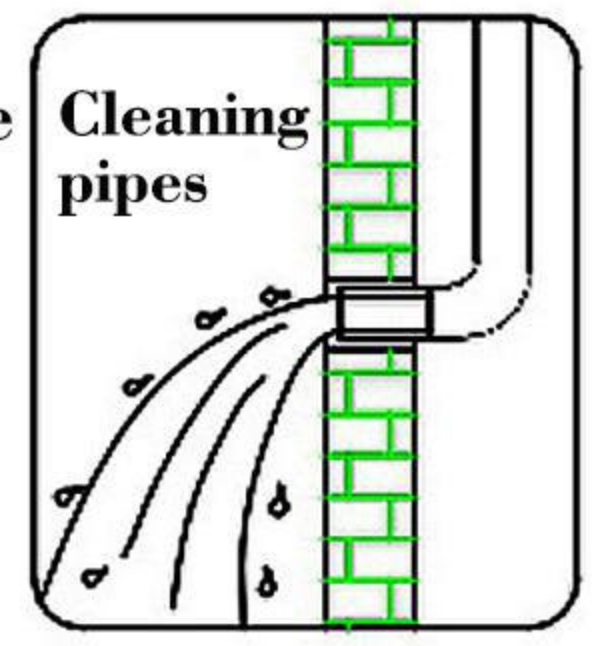

①19cm tub spout

②BATH and SHOWER switch

③handheld shower head

④Hot and cold water switch / handle

⑤handheld shower holder bracket

⑥60cm Hot and cold water inlet pipe

⑦40cm Connecting pipe

⑧1.5 m Shower hose

⑨Brass bracket

Check accessories

Standard List of Accessories:

When you open the product packaging, please check whether the objects in it are consistent with the main body and accessories you purchased. If there is any inconsistency, please contact our company or our distributor.

Note: 1. Accessories are subject to change without prior notice if the change does not affect usage;

2. The appearance of the product is subject to the physical objects you receive, and the schematic diagram is only for reference.

INSTALLATION STEPS

TIPS:

- ① Red as hot water pipe, Blue as cold water pipe
- ② Cleaning the hot and cold water inlet pipe to prevent debris from entering the inside, damaging the valve body and affecting the use.

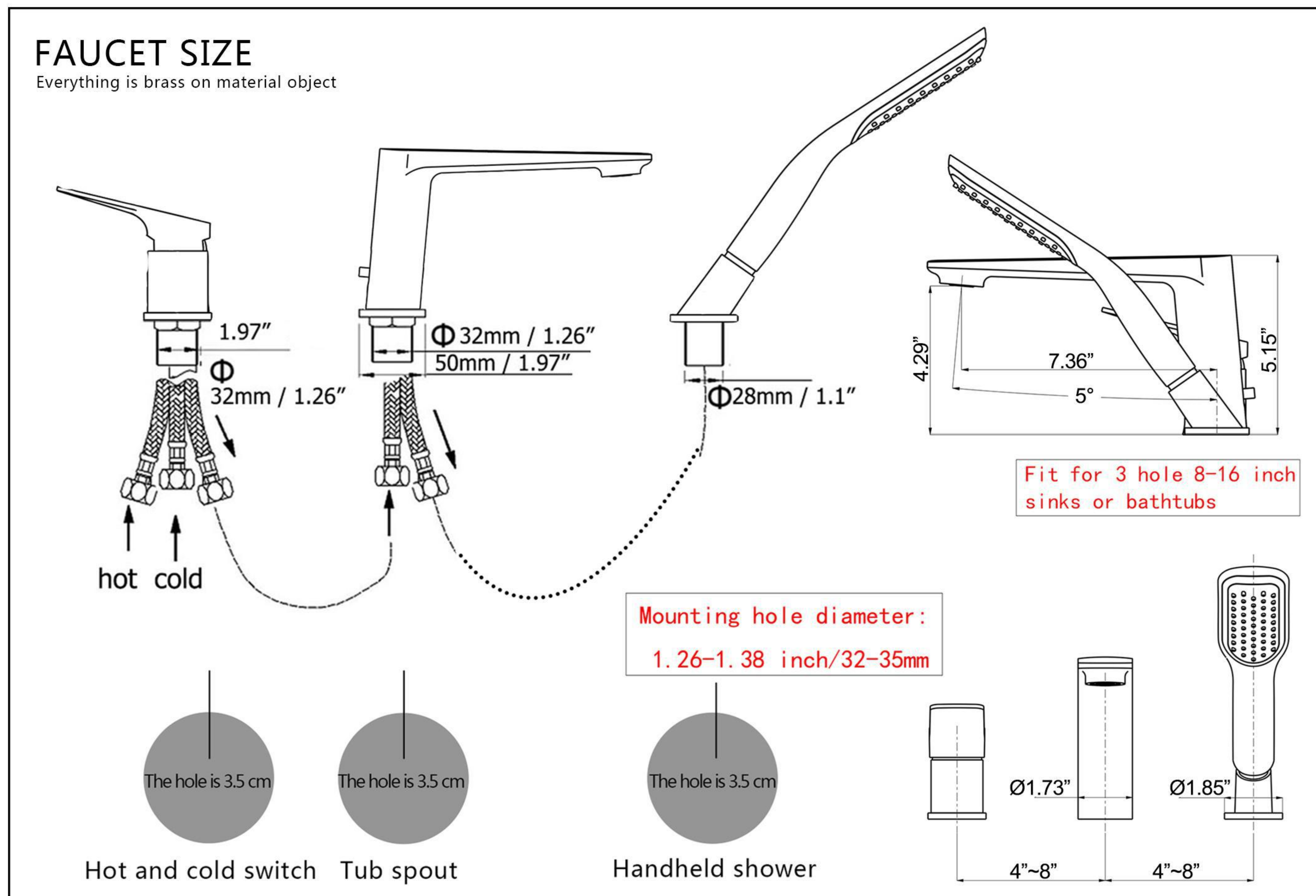

1. Take the tub faucet set in the corresponding hole on the bathtub. Fix the faucet body to the pipe and put the base cover over the base.
2. Screw the pipe to the corresponding base.
 - ① Install the flexible hose and ensure the flexible hoses are hand tightened into place. The flexible hoses are to be fitted into the correct inlets for hot water and for cold water. (DO NOT USE SPANNER TO TIGHTEN AS IT CAN DAMAGE THE O-RING).
 - ② Connect another side of the flexible hose to the water supply pipe. Make sure they are to be fitted into the correct outlets for hot water and cold water.
 - ③ Connect the shower hose and hand shower.
3. Finish.

CLEANING CARE

In order to keep the appearance of faucet clean, bright and good performance, please take care of the faucet as follows;

1. Rinse with water only and dry with soft cotton cloth;
2. Use mild liquid and colorless glass cleaner to remove surface dirt and scale film, or use polish without abrasive effect;
3. Do not use abrasive detergent, polish, emery cloth, paper towel or scraper, etc.;
4. Do not use acid cleaner, or cleaner and soap with insoluble gran etc.;
5. In the process of use, mud may accumulate in the bubbler and make the water flow show, The bubbler can be unscrewed, rinsed with water, and then installed back in place.



Please feel free to contact us if you have any questions. We will help to solve the issue together with you. OUR EMAIL: services@rbrohant.com



Service Contact:
+1(801) 800-9309
services@rbrohant.com

Made in China