

ASSEMBLY INSTRUCTIONS



Sofa

ASSEMBLY INSTRUCTIONS

ASSEMBLY TIPS:

1. Remove hardware from box and sort by size.
2. Please check to see that all hardware and parts are present prior to start of assembly.
3. Please follow attached instructions in the same sequence as numbered to assure fast & easy assembly.



WARNING!



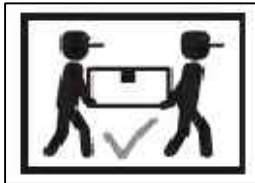

1. Don't attempt to repair or modify parts that are broken or defective. Please contact the store immediately.
2. This product is for home use only and not intended for commercial establishments.



ASSEMBLY TIME

10 MINUTES

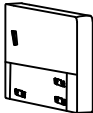
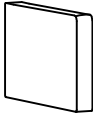
PARTS IDENTIFICATION

A	SEAT		1PC
B	BACK		1PC
C	RIGHT ARM		1PC
D	LEFT ARM		1PC
E	LEG		4PCS

HARDWARE IDENTIFICATION

1	PLASTIC WASHER (Ø50*2MM-BLK)		4PCS
---	---------------------------------	---	------

ASSEMBLY INSTRUCTIONS

STEP 1

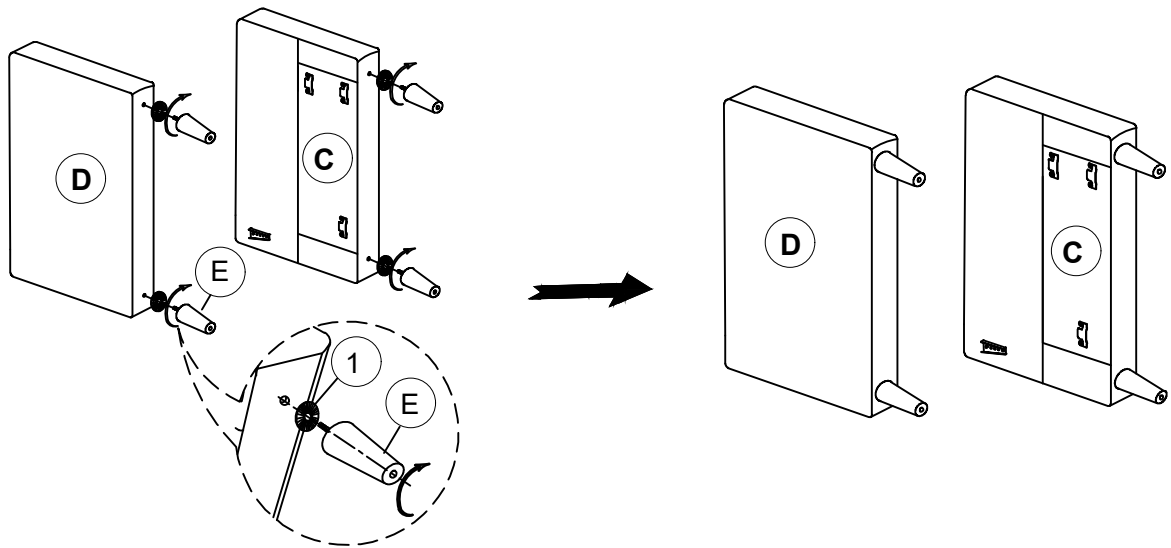

STEP 2

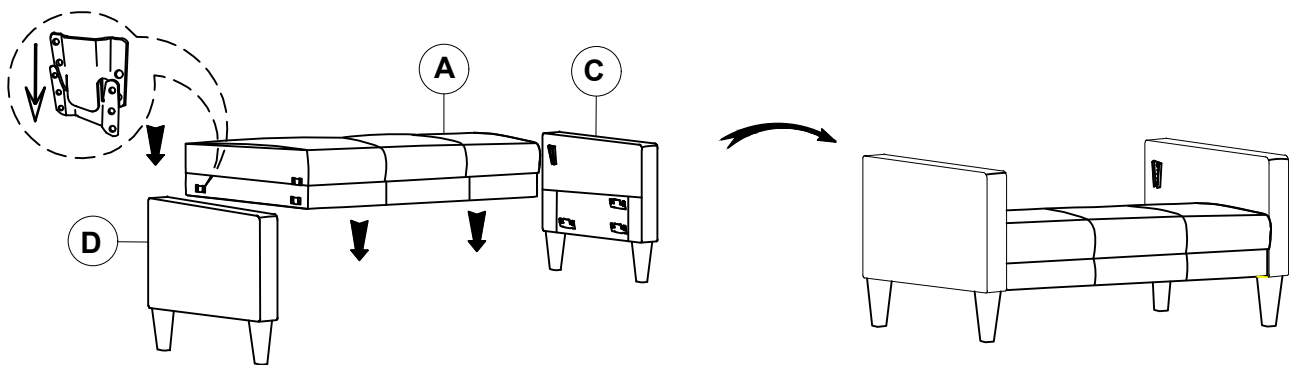

STEP 3 COMPLETE

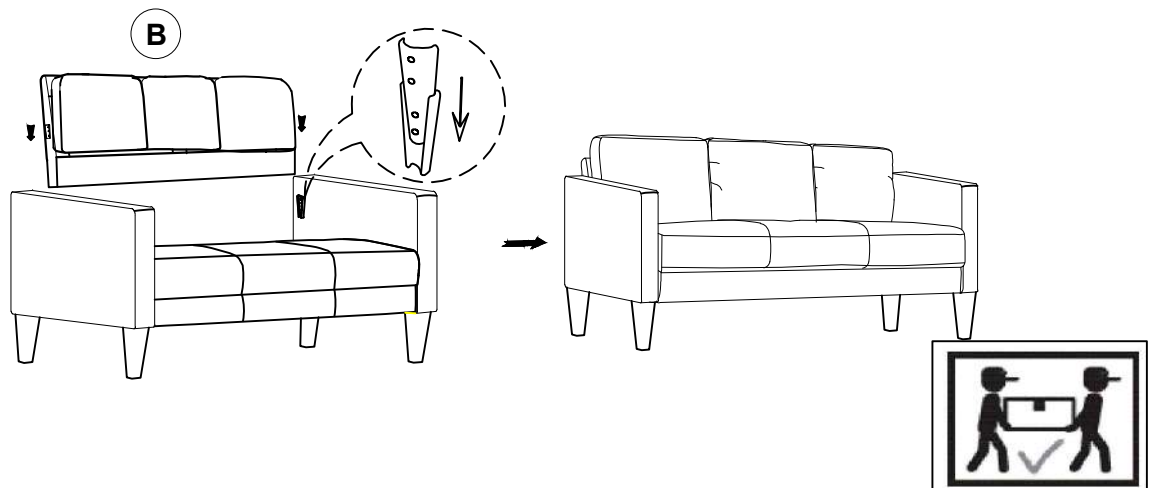

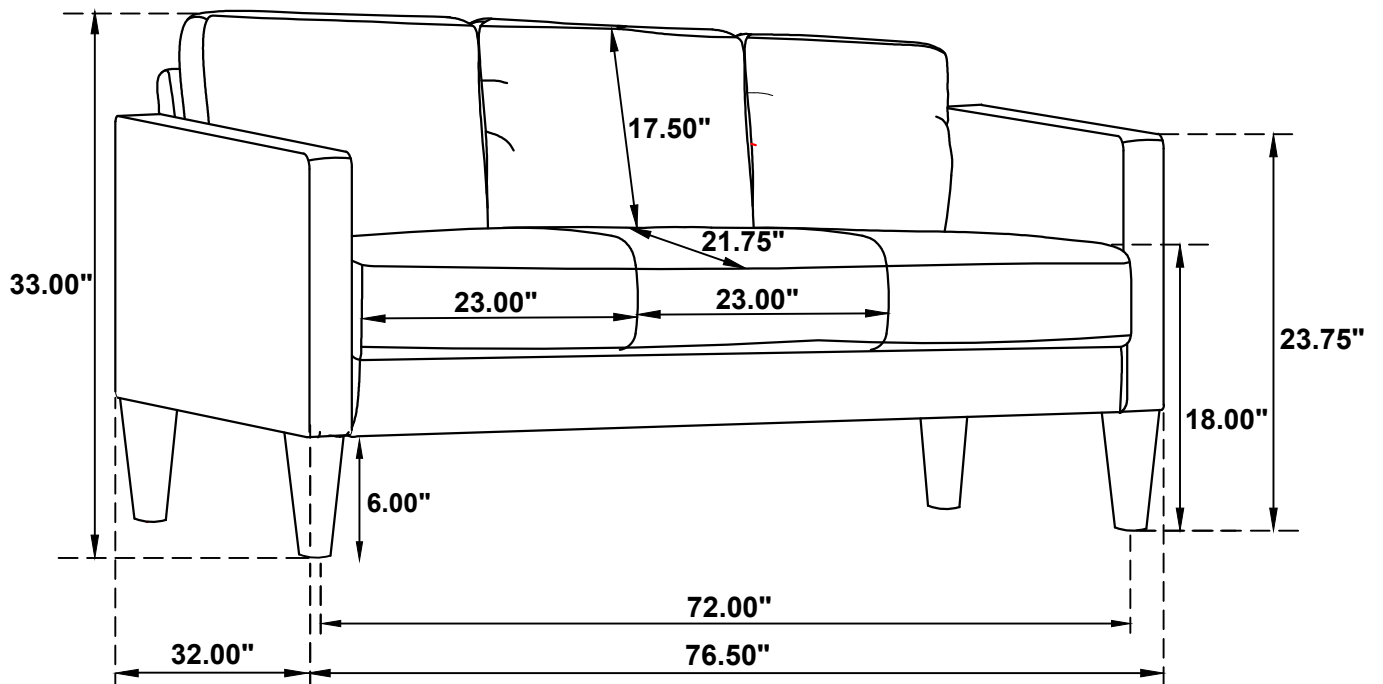

Note: Dimension tolerance $\pm 5\%$