

USER MANUAL

Thank you for purchasing our product.

For questions or assistance on assembly, parts or installation, please contact customer support:

Please include the product number, order number if any, and your phone number in the email. If there are broken or missing parts, please include the part numbers and quantities, and your address. We will ship you the replacement parts.

All emails will be answered within 24 hours.

For hard to explain problems, please send us a few pictures showing the problems if you can. We involve the factory technicians directly in the support, so you can be assured you will deal with the experts.

CAUTION

1. Rated 110~130V/60Hz, bulb 40W-60W maximum.
2. Care should be taken to avoid damage to the surface of lighting and wire. Wearing gloves are recommended when installing.
3. Keep lighting away from acid, alkali and other corrosive chemical or gas, clean the lighting with clean soft cloth only.
4. Installation must be carried out by qualified electrician only.
5. Disconnect the power before installing, cleaning and replacing lighting.
6. Never cover the lighting when power is connected.

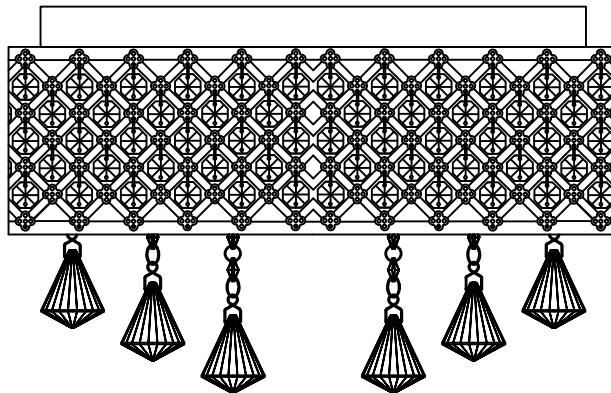

The wiring connection of luminaire and outlet box

There are two main wires. One is in black and the other is in white. Be sure to connect, the black wire (positive electrode) to the outlet box wire (positive electrode), the white wire (negative electrode) to the outlet box wire (negative electrode) and the copper fixture ground wire to the supply ground wire with wire connectors.

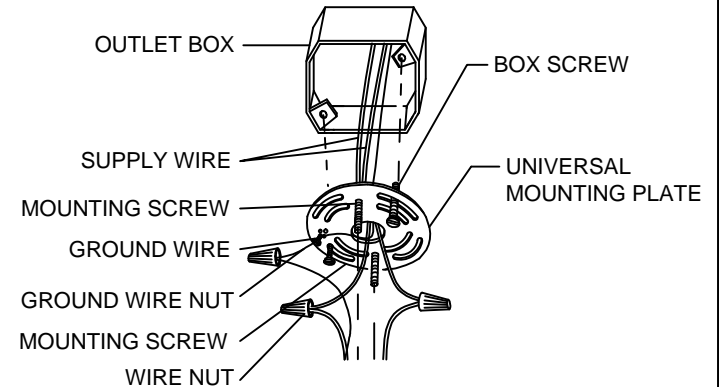

Requires E12 40W-60W bulbs (not included)

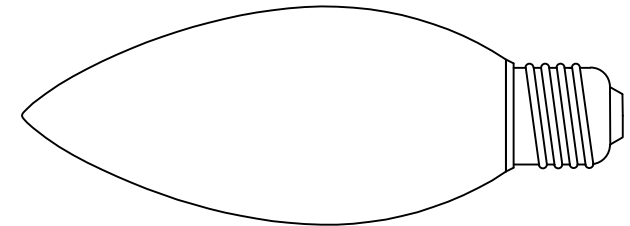

INSTRUCTION

1A. Lock the crossbar on the junction box of the ceiling by using 2 pcs of 5/32 screws in the accessories bag.
 1B. Connect the wires. The black wire is the hot /positive (+) wire. The white wire is the negative (-) wire.
 1C. Cover the ceiling canopy and attach the screws to the canopy.

2. Install 4 E12 bulbs (Not included).





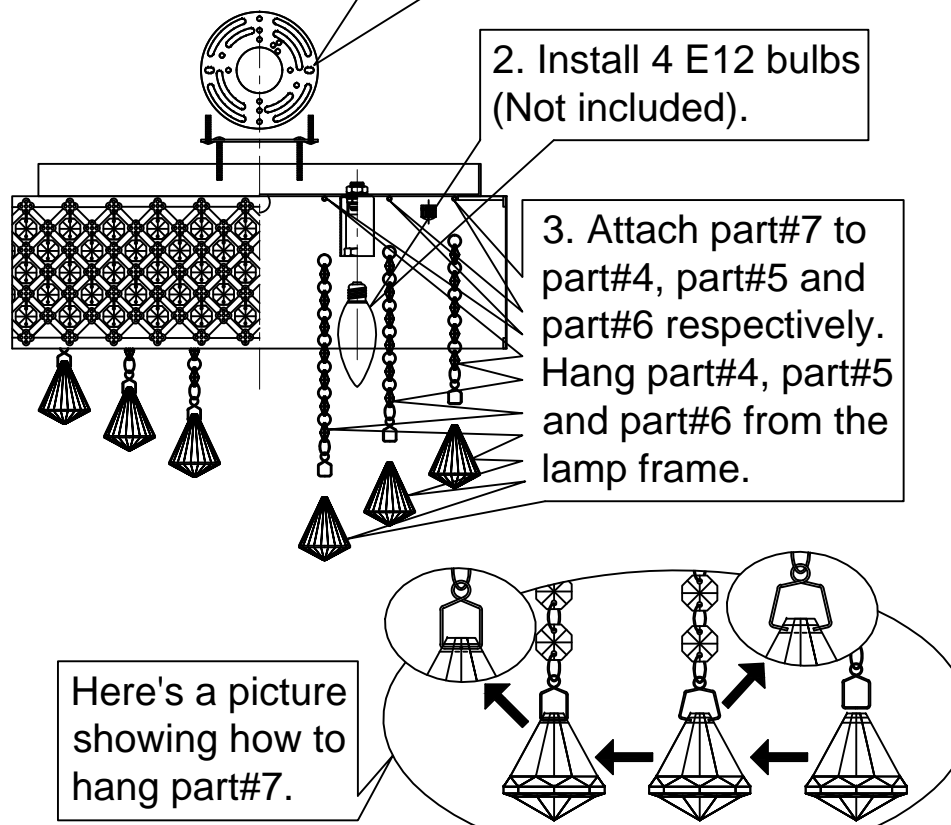

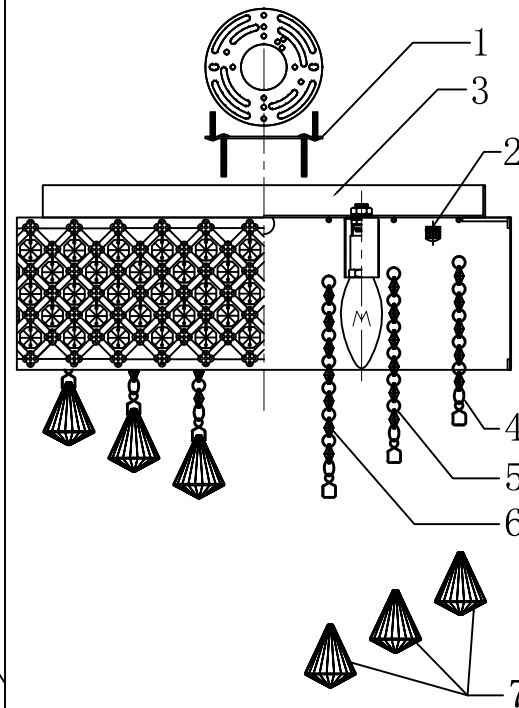

3. Attach part#7 to part#4, part#5 and part#6 respectively. Hang part#4, part#5 and part#6 from the lamp frame.

Here's a picture showing how to hang part#7.

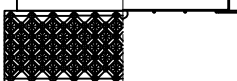

Please note: The parts in this table are completely unassembled, for illustrative purpose. In the actual product that you receive, some parts are assembled and attached together.



Part Number	Graphics	Quantity
1		1
2		2
3		1
4		16
5		10
6		6
7		32
spare part		1
		5