

CARE AND MAINTENANCE

Store outdoor furniture indoors or cover well when not in use.
Remove wooden furniture from standing water. Dust regularly with small brush or vacuum
Spills should be taken care of immediately before they harden or stain with a slightly dampened sponge.



















NOTICE

- * Please make sure that you have all parts indicated before you begin assembly of this item
- * This item should be assembled on a soft surface to prevent scratching the finish during assembly
- * This item may require periodic tightening

**Weight Capacity : 275 lbs (single seat)
550 lbs (towperson seat)**

**Warning : Do not stand on Table
Warning : Do not over torque bolts/screws**

Part List and Hardware List

PIECE	DESCRIPTION	PICTURE	QUANTITY
1	Chair/Bench left frame		3X
2	Chair/Bench right frame		3X
3	Bench seat frame		1X
4	Chair seat frame		2X
5	Bench back frame		1X
6	Chair back frame		2X
7	Table top		1X
8	Right leg table		1X
9	Left leg table		1X
10	Table botton frame		1X
11	Bench seat cushion		1X
12	Chair seat cushion		2X
13	Table glass		1X
A	Allen bolt(M6x20 mm)		4X
B	Allen bolt(M6x30 mm)		10X
C	Allen bolt(M6x40 mm)		24X
D	Allen bolt(M6x60 mm)		6X
E	Flat washer		44X
F	Allen key		3X



42.51"x20.86"x31.49" H (Bench)
22.44"x20.86"x31.49" H (Chair)
26.77"x14.96"x16.14" H (Table)

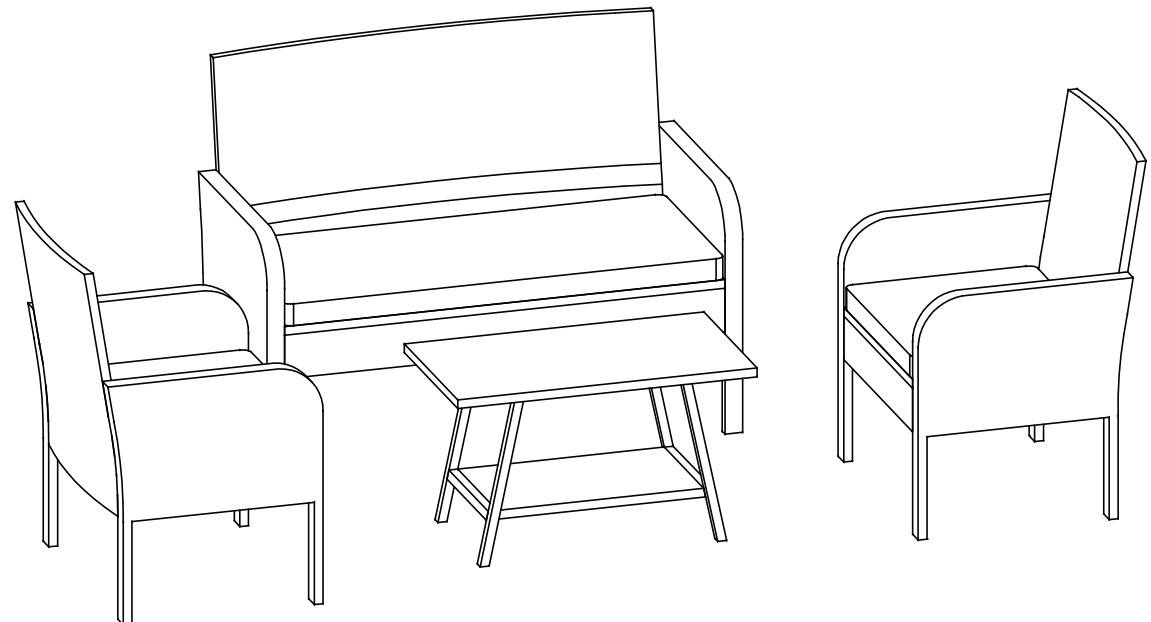

CARE AND MAINTENANCE

Store outdoor furniture indoors or cover well when not in use.
Remove wooden furniture from standing water. Dust regularly with small brush or vacuum
Spills should be taken care of immediately before they harden or stain with a slightly dampened sponge.

NOTICE

- * Please make sure that you have all parts indicated before you begin assembly of this item
- * This item should be assembled on a soft surface to prevent scratching the finish during assembly
- * This item may require periodic tightening









**Weight Capacity : 275 Lps (single seat)
550 Lps (towperson seat)**

Warning : Do not stand on table

Warning : Do not over torque bolts/screws



Part List and Hardware List

PIECE	DESCRIPTION	PICTURE	QUANTITY
7	Table top		1X
8	Right leg table		1X
9	Left leg table		1X
10	Table botton frame		1X
13	Table glass		1X
A	Allen bolt(M6x20 mm)		4X
B	Allen bolt(M6x30 mm)		4X
E	Flat washer		8X
F	Allen key		1X

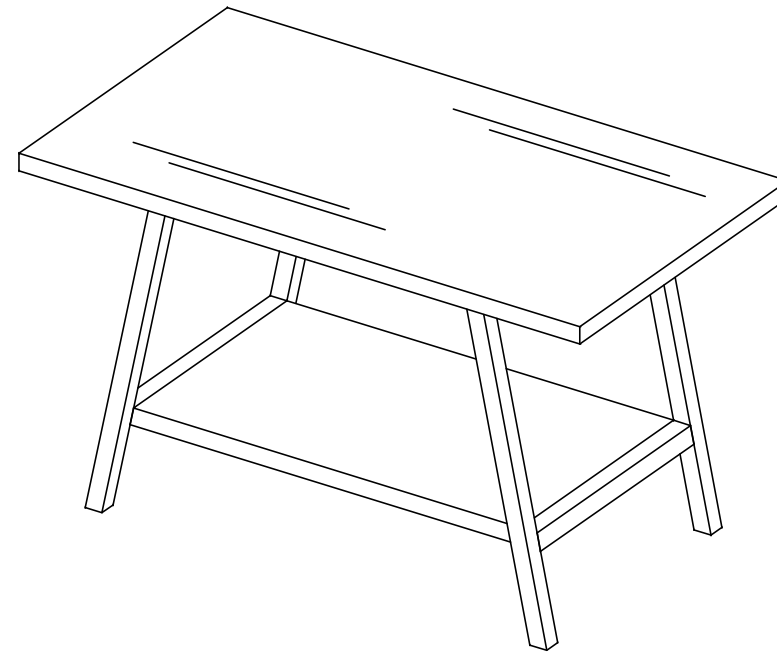

1

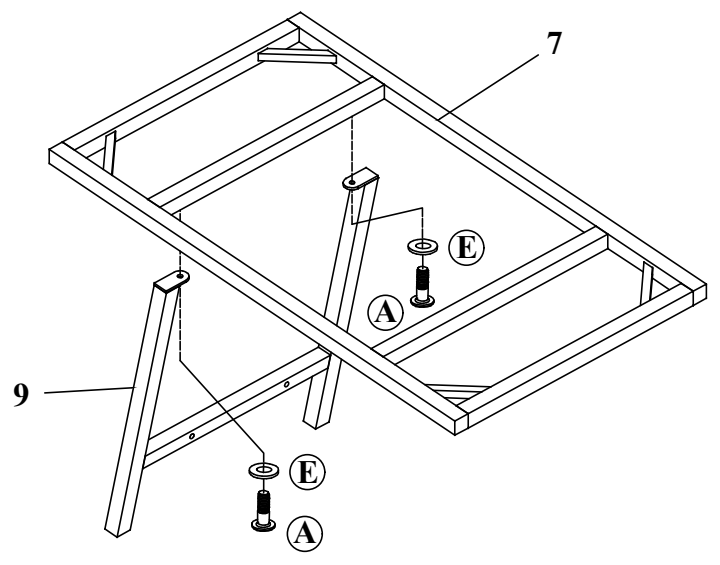

Step 1
Connect Leg Left Table (9) & Table Top (7), tighten Bolt (A) with Allen Key (F)

2

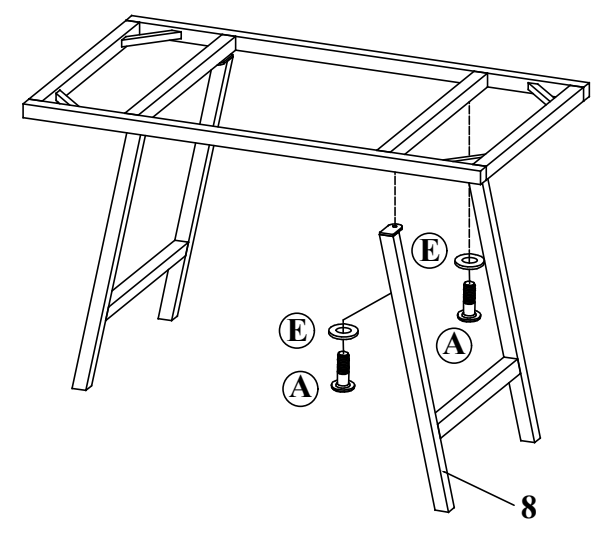

Step 2
Connect part from Step 1 & Leg Right Table (8), tighten Bolt (A) with Allen key (F)

3

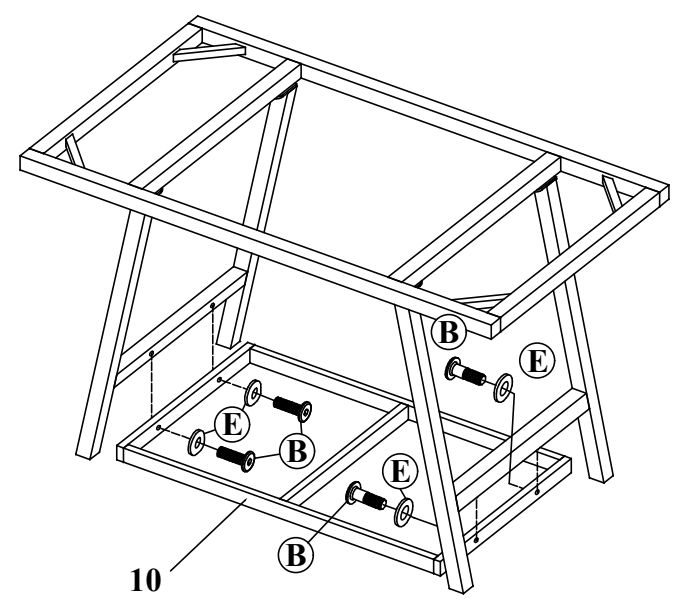

Step 2
Connect part from Step 1 & Table Bottom Frame (10), tighten Bolt (B) with Allen key (F)

4

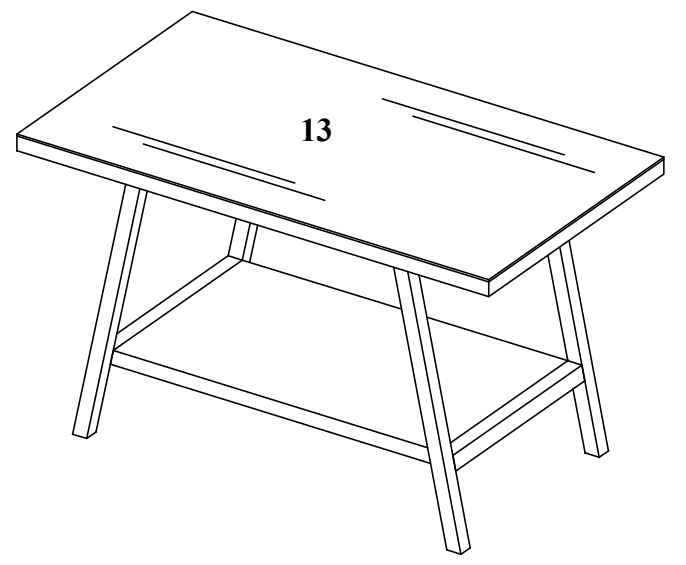

Step 4
Put on Glass Table (13) to complete Table