

Installation & Assembly

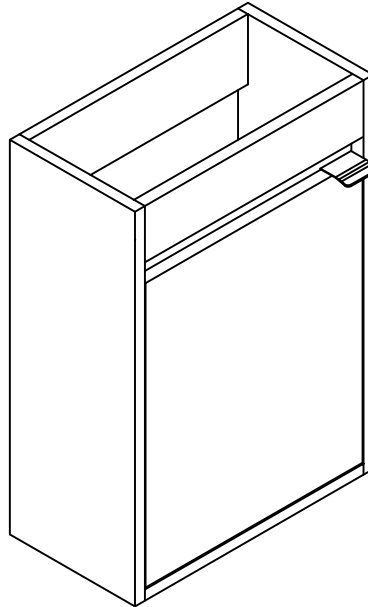

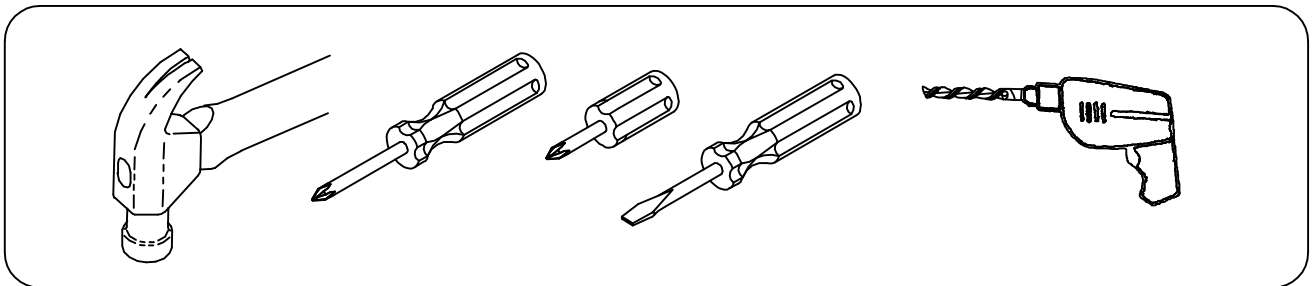





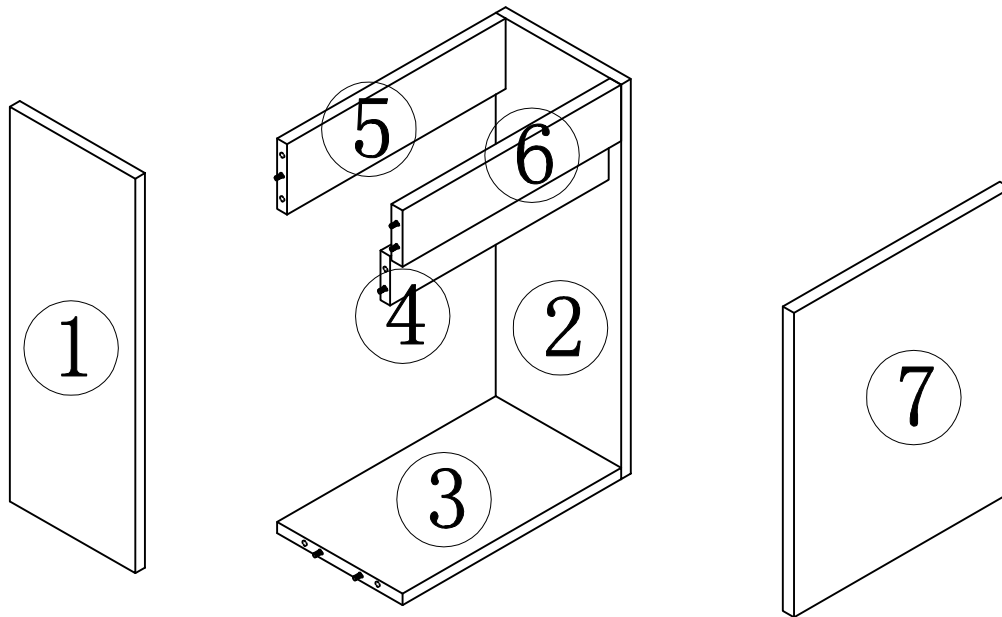





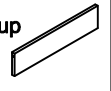

YOU MAY NEED (NOT SUPPLY)

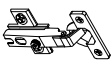

ASSEMBLY DIAGRAM



PARTS LIST					
PARTS LIST					
NO	DESCRIPTION	QTY	NO	DESCRIPTION	QTY
①	Left side panel 	1	⑤	rear drop down 	1
②	Right side panel 	1	⑥	Front baffle panel 	1
③	Bottom panel 	1	⑦	Left door panel 	1
④	front pull-up 	1			

PARTS LIST					
HARDWARE LIST					
NO	DESCRIPTION	QTY	NO	DESCRIPTION	QTY
A	Three-in-one eccentric wheel 	10	E	Door hinge 	2
B	Three-in-one connecting rod 	10	F	4*16mm screw 	14
C	Three-in-one sticker 	10	G	Door handle 	1
D	8*40mm wood dowel pins 	12			

CAUTION:
Please confirm the parts list before installation

STEP 1

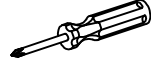
HARDWARE LIST	
Three-in-one connecting rod B  10PCS	

1. Put the three-in-one connecting rod in the 10mm hole of the following panels and tighten them with a cross screwdriver or an electric tool.

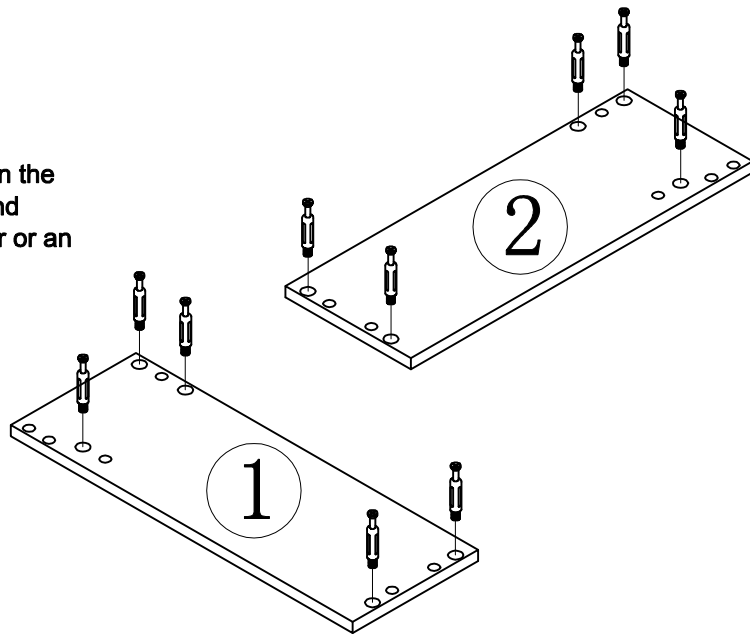
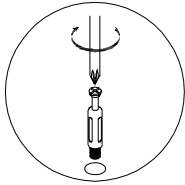

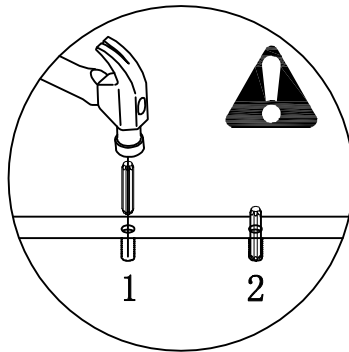

STEP 2

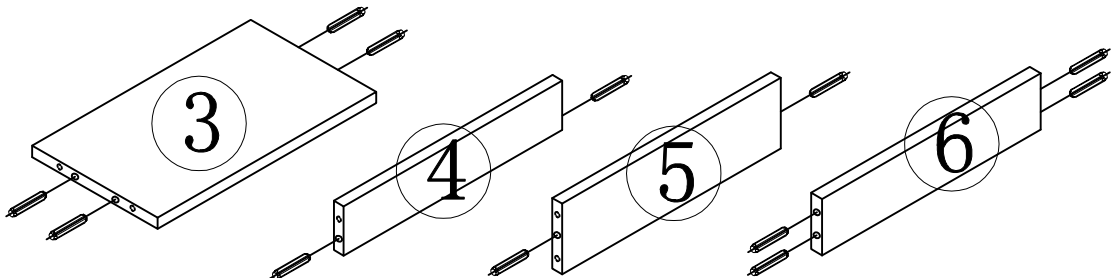

1. Strike the 08*40mm wood dowel pin into the 8mm hole of the above panels with an iron hammer. Please note that the hole of the three-in-one connecting rod should also be 8mm. The hole of the three-in-one connecting rod connects to the hole of 15mm three-in-one eccentric wheel.



HARDWARE LIST	
8*40mm wood dowel pins D  12PCS	

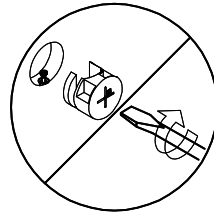
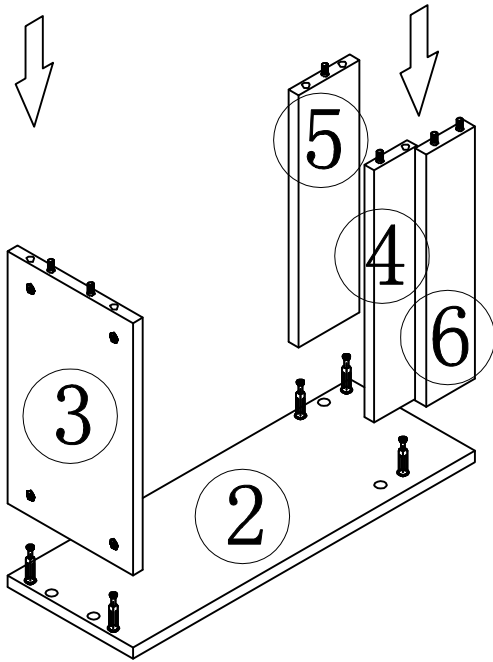

STEP 3

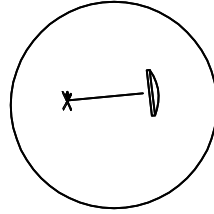

1. Connect No. 3-4-5-6 panel to No.2 panel tightly with the three-in-one eccentric wheel.



2. Cover the mounting hole of the eccentric wheel with a three-in-one sticker.

HARDWARE LIST		
Three-in-one eccentric wheel A  5PCS	Three-in-one sticker C  5PCS	

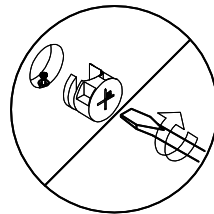
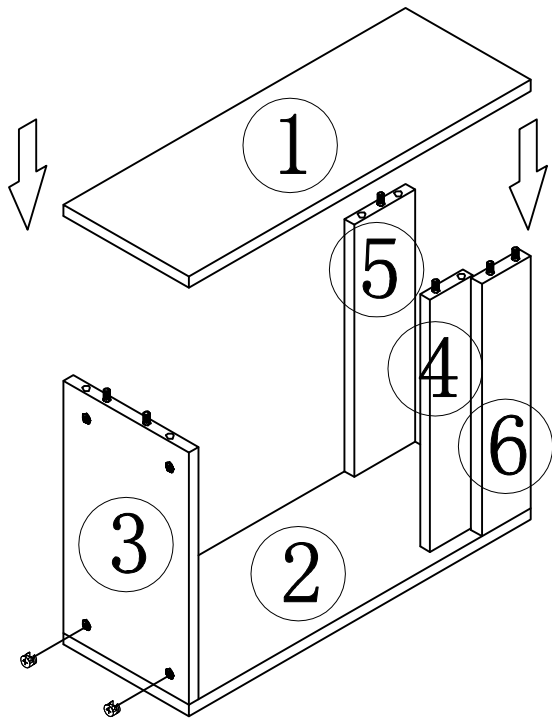

STEP 4

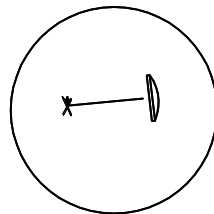

1. Connect No. 1 panel to No. 3-4-5-6 panel tightly with the three-in-one eccentric wheel.



2. Cover the mounting hole of the eccentric wheel with a three-in-one sticker.

HARDWARE LIST		
Three-in-one eccentric wheel A  5PCS	Three-in-one sticker C  5PCS	

STEP 5

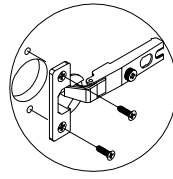
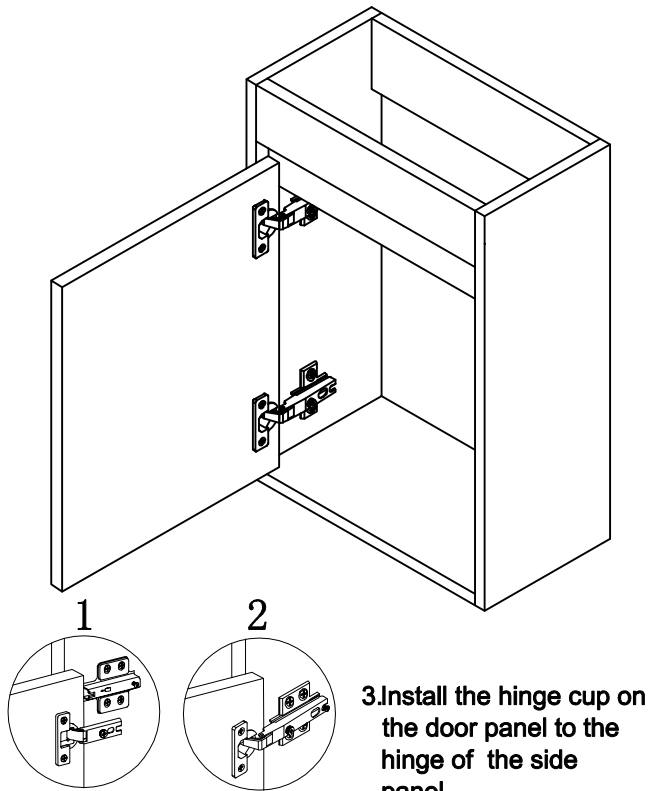

1. Install the hinge cup to the door panel with 4*16mm screws.

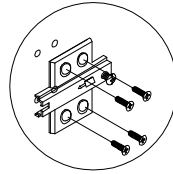

2. Install the hinge to the side panel with 4*16mm screws.

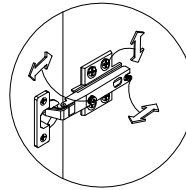

4. Adjust the door panel clearance.

HARDWARE LIST		
4*16mm screw	Door hinge	
F  12PCS	E  2PCS	

STEP 6

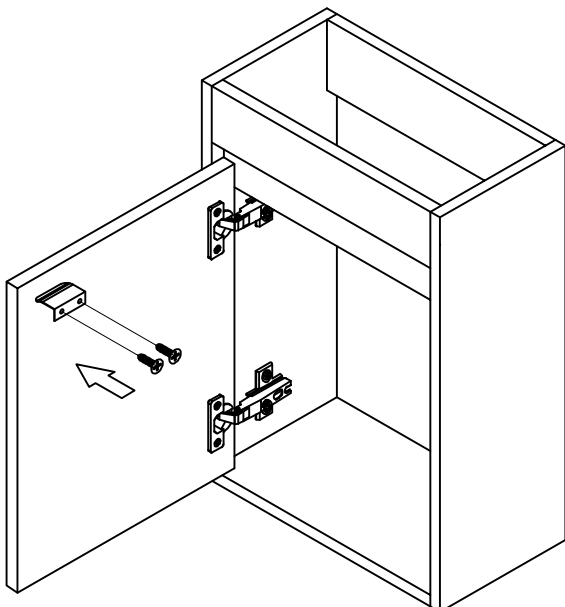

1. Install the door handle with 4*16mm screws.

HARDWARE LIST		
4*16mm screw	Door handle	
F  2PCS	G  1PCS	



Choking hazard-Small Parts : This unit contains small parts, not for children under 3 years.

Tip-over hazard : Secure finished unit to wall stud using L-Bracket and wall screw (#10*1.5"W/out provided). If a wall stud is not neccessible , Consault your local hardware store for appropriate mounting hardware . Failure to properly install will result in product collapse or tip-over. Serious injury can occur .