

INSTALLATION MANUAL

CHANDELIER

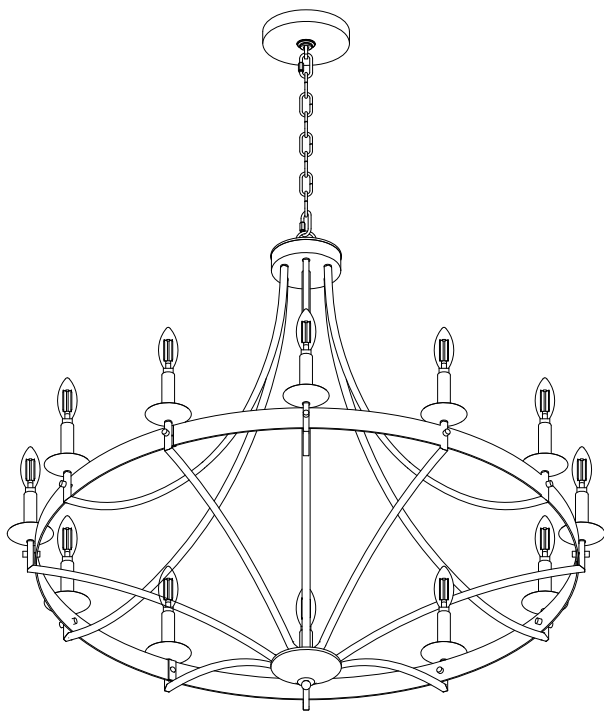

Safety Rules

WARNING: BE SURE THE ELECTRICITY TO THE WIRES YOU ARE WORKING ON IS SHUT OFF; EITHER THE FUSE IS REMOVED OR THE CIRCUIT BREAKER IS TURNED OFF. TURNING THE POWER OFF USING THE LIGHT SWITCH IS NOT SUFFICIENT TO PREVENT ELECTRICAL SHOCK.

NOTE: The important safeguards and instructions appearing in this manual are not meant to cover all possible conditions or situations that may occur. It must be understood that common sense, caution, and care, are factors which cannot be built into any product. These factors must be supplied by the person(s) installing this unit.

READ & SAVE THESE INSTRUCTIONS

CAUTION: Before assembling the lighting fixture, refer to the section titled Wiring Connections. If you feel you do not have enough electrical wiring experience, either refer to a do-it-yourself wiring handbook or have your lighting fixture installed by a qualified, licensed electrician.

INSTALLATION & OPERATION INSTRUCTIONS GENERAL

Before starting the installation, disconnect the power by turning off the circuit breaker or by removing the appropriate fuse at the fuse box. Turning the power off using the light switch is not sufficient to prevent electrical shock.

All electrical connections must be in accordance with local and National Electrical Code (NEC) standards. If you are unfamiliar with proper electrical wiring connections, obtain the services of a qualified electrician.

Installation Preparation

Tools You Need

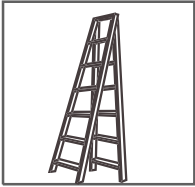

Ladder

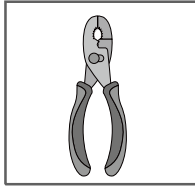

Pliers

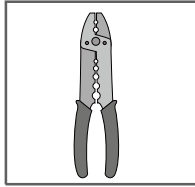

Wire Strippers

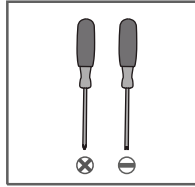

Screwdrivers

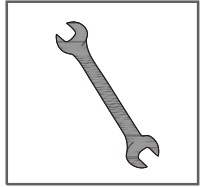

Wrench

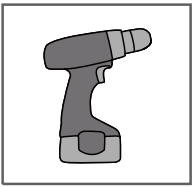

Power Drill
(optional)

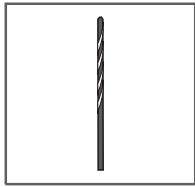

Drill Bit
(optional)

What to Expect with your Installation





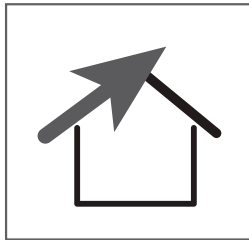







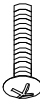

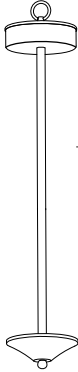
Check the box to see the weight of the light

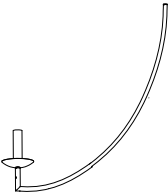
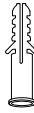

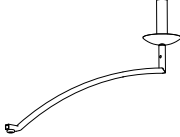
Angled ceiling applicable

Packing List

 <p>————— A Mounting Bracket x 1</p>  <p>————— B Canopy x 1</p>  <p>————— C Sling Chain x 1</p>	<p>AA 2x</p>  <p>Outlet Box Screw</p>	<p>BB 7x</p>  <p>Wire Nut</p>	
 <p>————— D Lamp Pole x 1</p>	<p>CC 4x</p>  <p>Wood Screw</p>	<p>DD 4x</p>  <p>Washer</p>	
 <p>————— E Long Lamp Arm x 6</p>	<p>EE 4x</p>  <p>Anchor Bolt</p>	<p>FF 24x</p>  <p>Cap Nut</p>	
 <p>————— F Short Lamp Arm x 6</p>  <p>————— G Lamp Frame x 3</p>	<p>GG 3x</p>  <p>Long Fixed Screw</p>	<p>HH 9x</p>  <p>Short Fixed Screw</p>	<p>II 1x</p>  <p>Gloves</p>

NOTE: The listed quantity is for installation, extra hardware may be included.

Installation Instructions

1. Mount the Bracket

Option 1. Secure the mounting bracket (A) to the outlet box with screws taken off from outlet box or screws (AA) and washers (DD) provided.

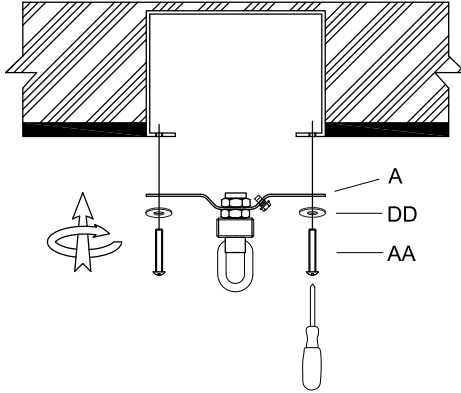

Option 2. Mark and drill the screw holes (Use a 1/8" drill bit) on the solid wood structure. Mount the mounting bracket with wood screws (CC) and washers (DD).

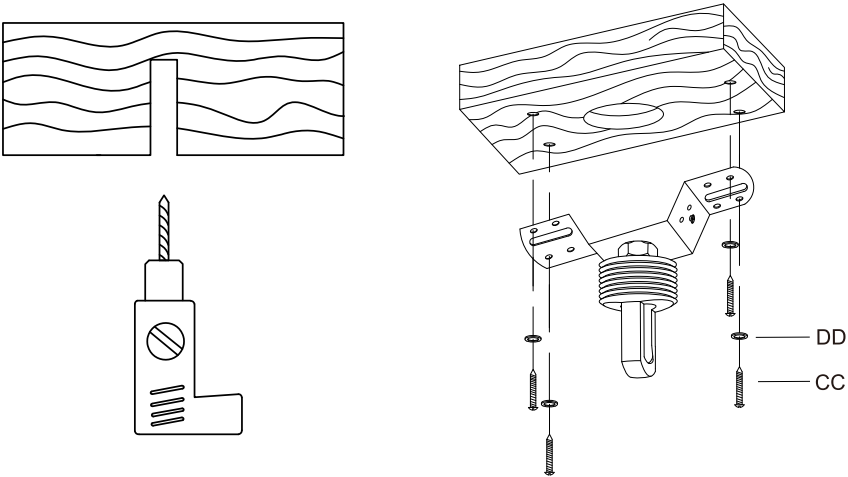

Option 3. (For Concrete Structure)

Mark and drill the anchor holes (Use a 5/16" drill bit) on the concrete structure. Mount the mounting bracket to the concrete structure with anchors (EE).

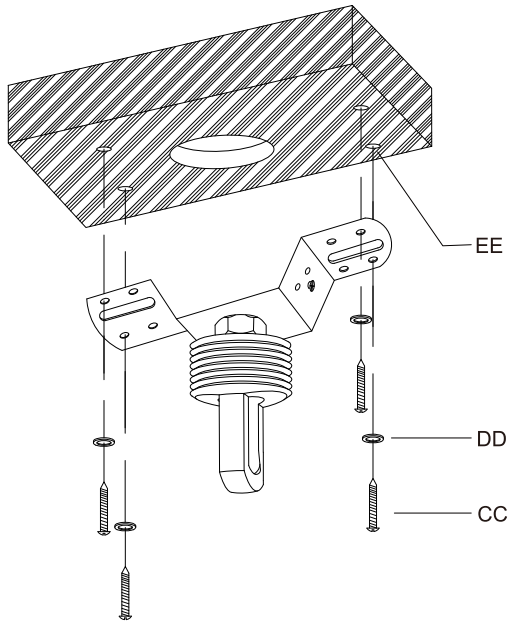
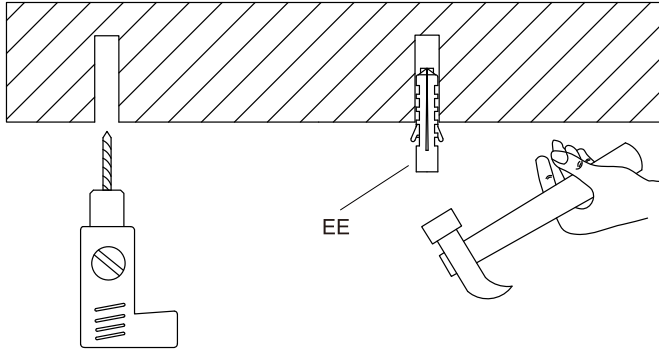

2. Install the Lamp Arm

Step 1: Tighten the top and bottom screws on the pole to fix the lamp pole (D).

Step 2: Loosen the hanging loop and dome nut, then remove the top cover and base cover from lamp pole (D).

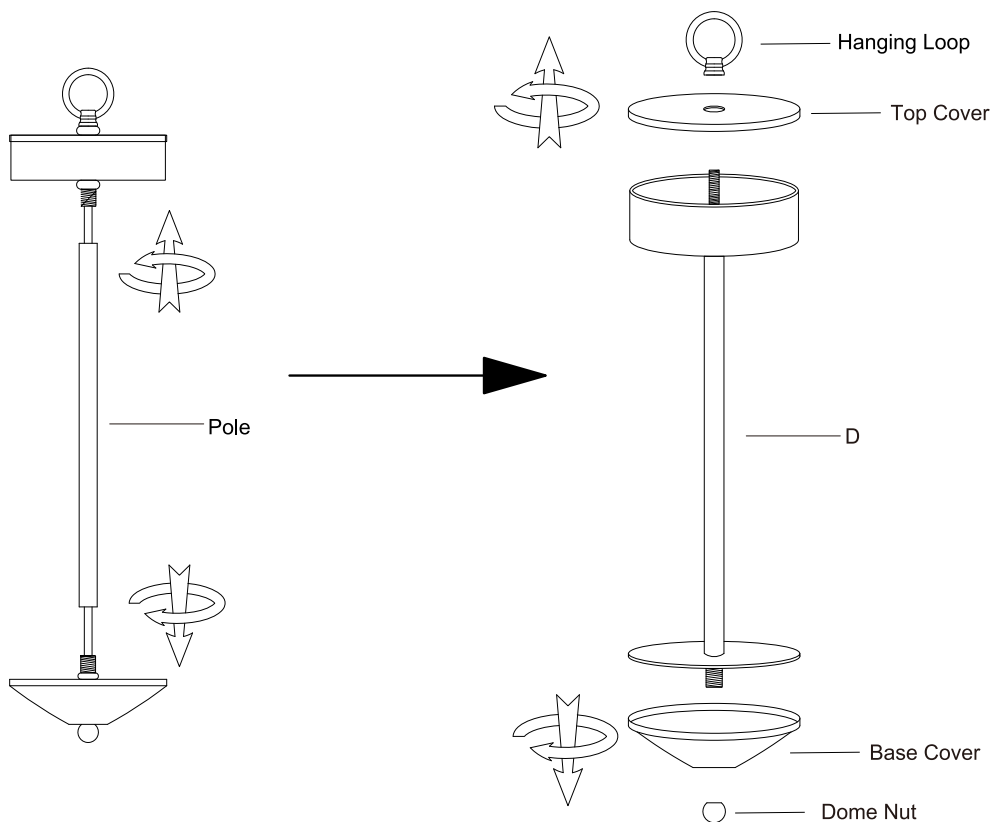

Step 3: Loosen the hex nut and washer of the lamp arm (E/F).

Step 4: Attach all the lamp arms (E/F) onto the lamp pole (D), and secure them with washers and hex nuts.

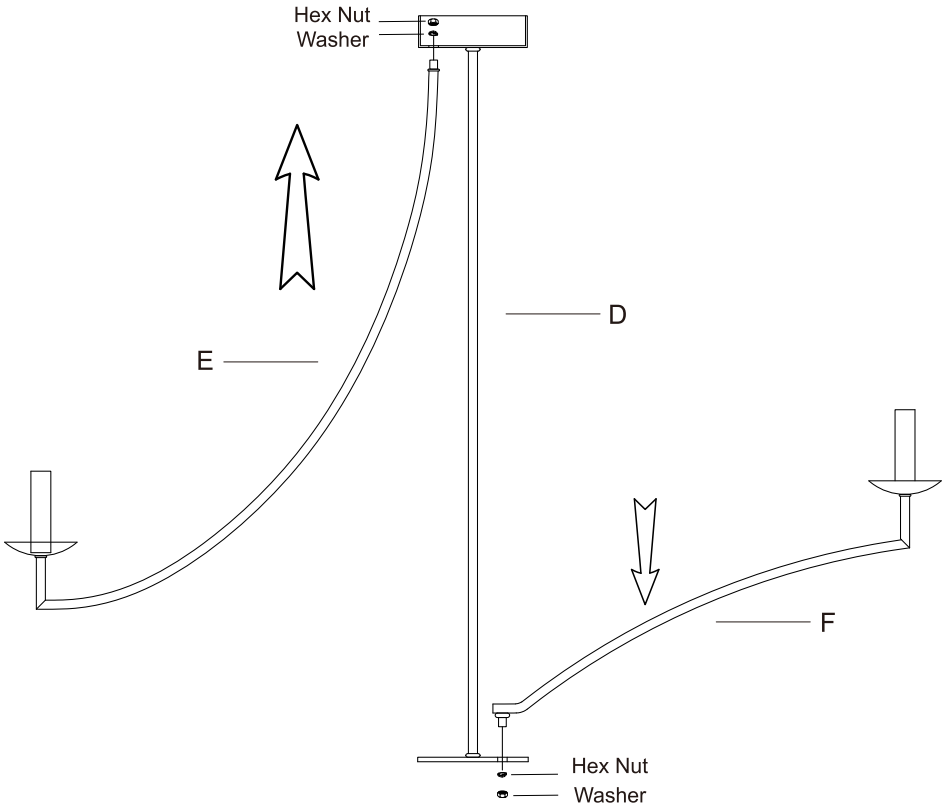

Step 5: Connect the wires of the lamp arm to the main wires at the top and bottom of the fixture with wire nuts (BB). (Black to black, white to white).

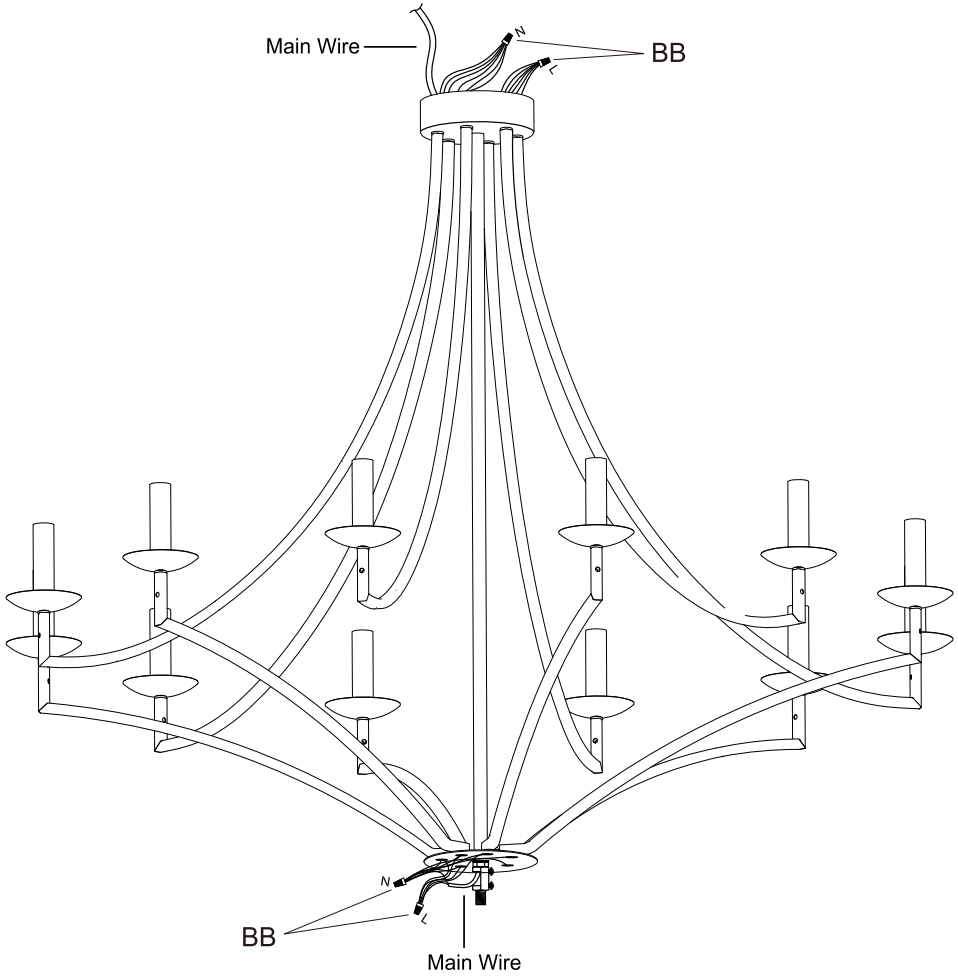

Step 6: Secure the base cover with the dome nut and the top cover with the hanging loop to lamp pole (D).

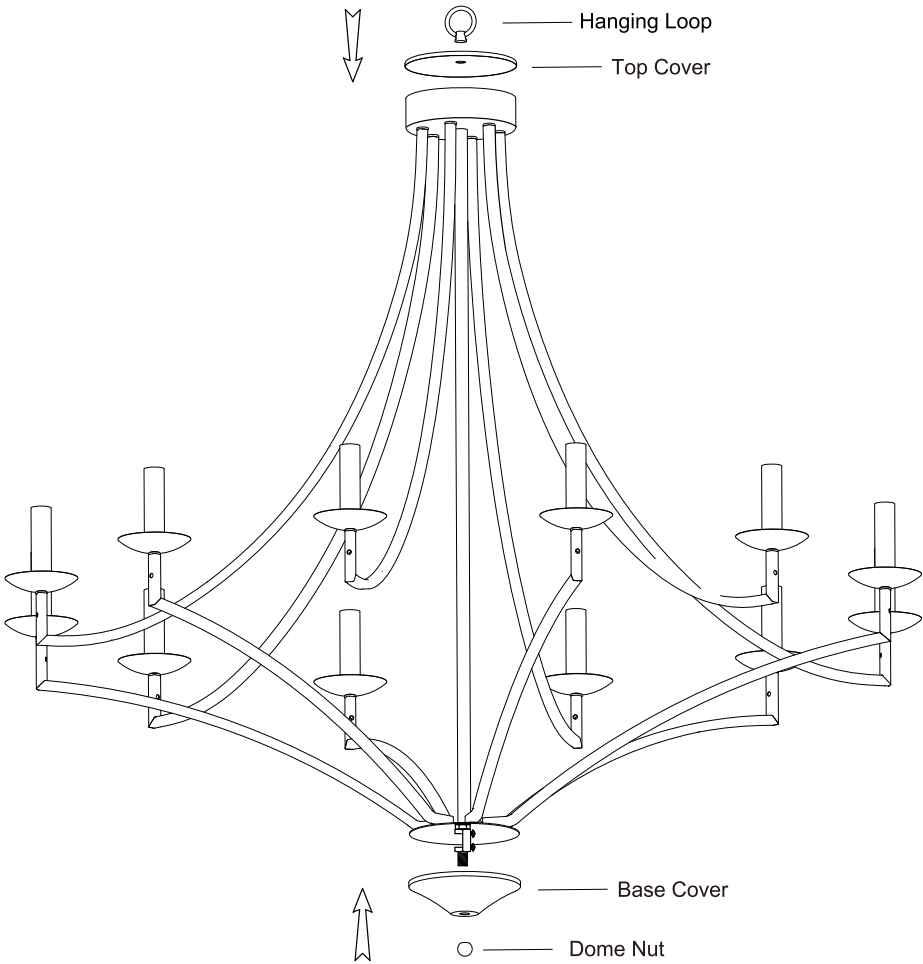

3. Assemble the Lamp Frame

Connect the lamp frames (G) to the lamp arm (E/F) with fixed screws (GG/HH) and cap nuts (FF).

Note: The long fixed screws (GG) are only used where the two frames are connected.

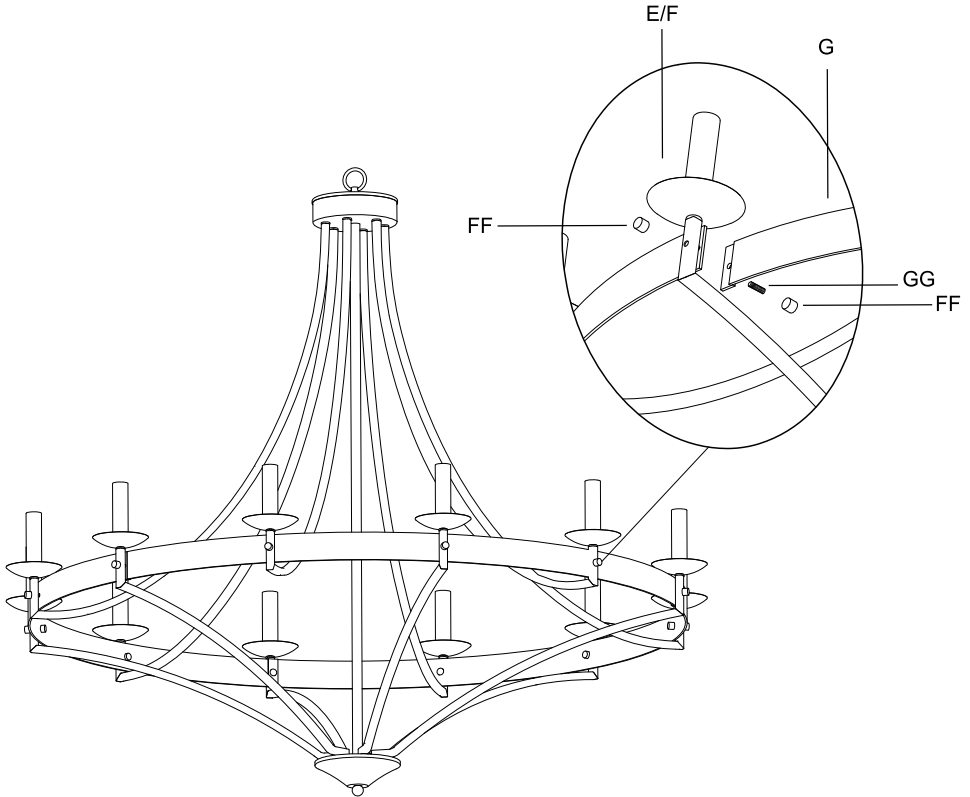

4. Connect the Wires & Fix the Fixture

Step 1. Loosen the fixed buckle from mounting bracket (A).

Step 2. Pass the sling chain (C) through the fixed buckle and canopy (B) in sequence, and connect both ends to the bracket and hanging loop.

Step 3. Pass the main wire through the hanging loop, fixed buckle, canopy, and mounting bracket in sequence.

Step 4. Connect the wires from the fixture to the house supply wires with wire nuts (BB), ground wire (green, green/yellow, or bare copper) to ground wire, neutral wire (white) to neutral wire, and hot wire (black) to hot wire. Wrap the connection with electrical tape.

Step 5. Slide the canopy up to the ceiling, rotating fixed buckle to fix the canopy.

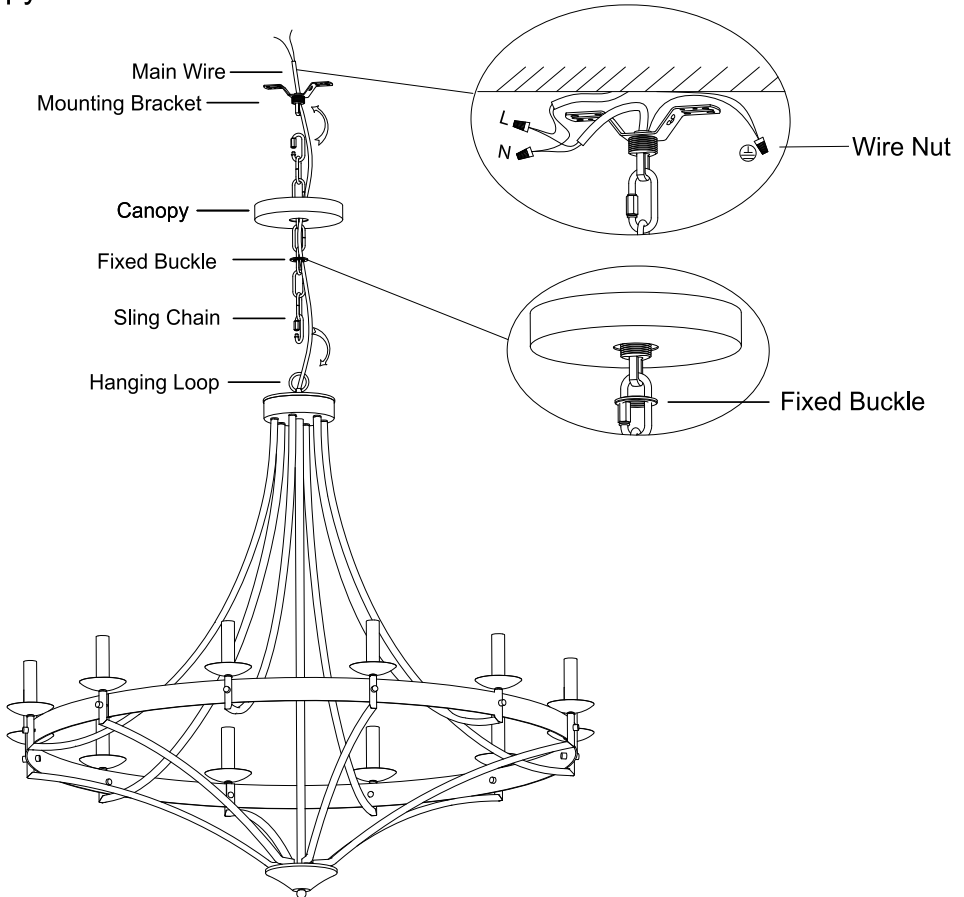

5. Install the Bulbs

Install Bulbs (E12 x 12, Max 40W each, not included).

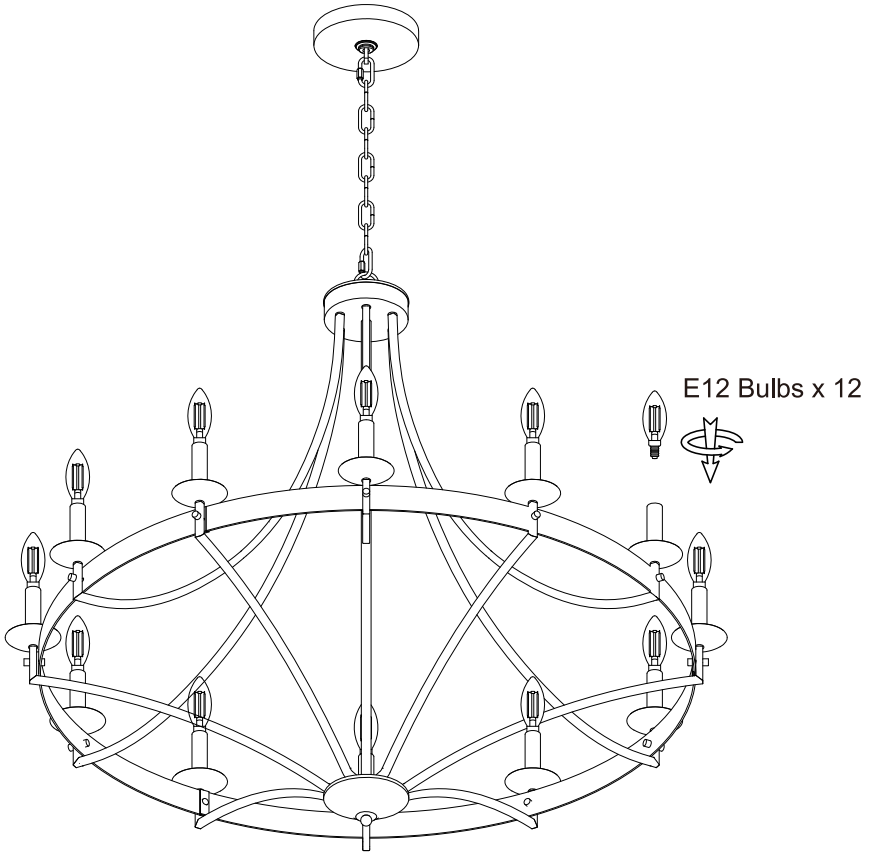

Note:

To achieve dimming functionality, you need to use dimmable bulbs and a dimmer switch.

For bulbs with color temperature control, repeatedly switch “on” and “off” using the wall switch to change settings.

Trouble Shooting

1. Missing / Broken Parts

- Make a list of the missing/broken parts according to the packing list, take photos for broken parts, then email us for free replacements.

2. Bulbs Do Not Light Up

- Check your power and switch to make sure it's power on.
- For regular bulbs, make sure it is connected to the ON/OFF wall switch, not the dimmer switch.
- Replace the bulb with a new one.

3. Bulbs Flicker

- If it is a dimmer switch, use a dimmable bulb.
- Replace the bulb with a new one.

4. Could Not Install / Assemble

- Take photos of the ceiling / fixture, contact seller for technical support.

Clean And Care

To clean, wipe the fixture with a soft cloth. Spraying from chemical cleaners can discolor the finish of the fixture.

Do not use scouring pads, powders, steel wool, or abrasive paper to clean this fixture.

Ordering Parts

Keep this manual for future reference, and in case replacement parts are needed. Available parts can be ordered from the place of purchase. Use exact wording from diagrams when ordering parts.