

ASSEMBLY INSTRUCTIONS

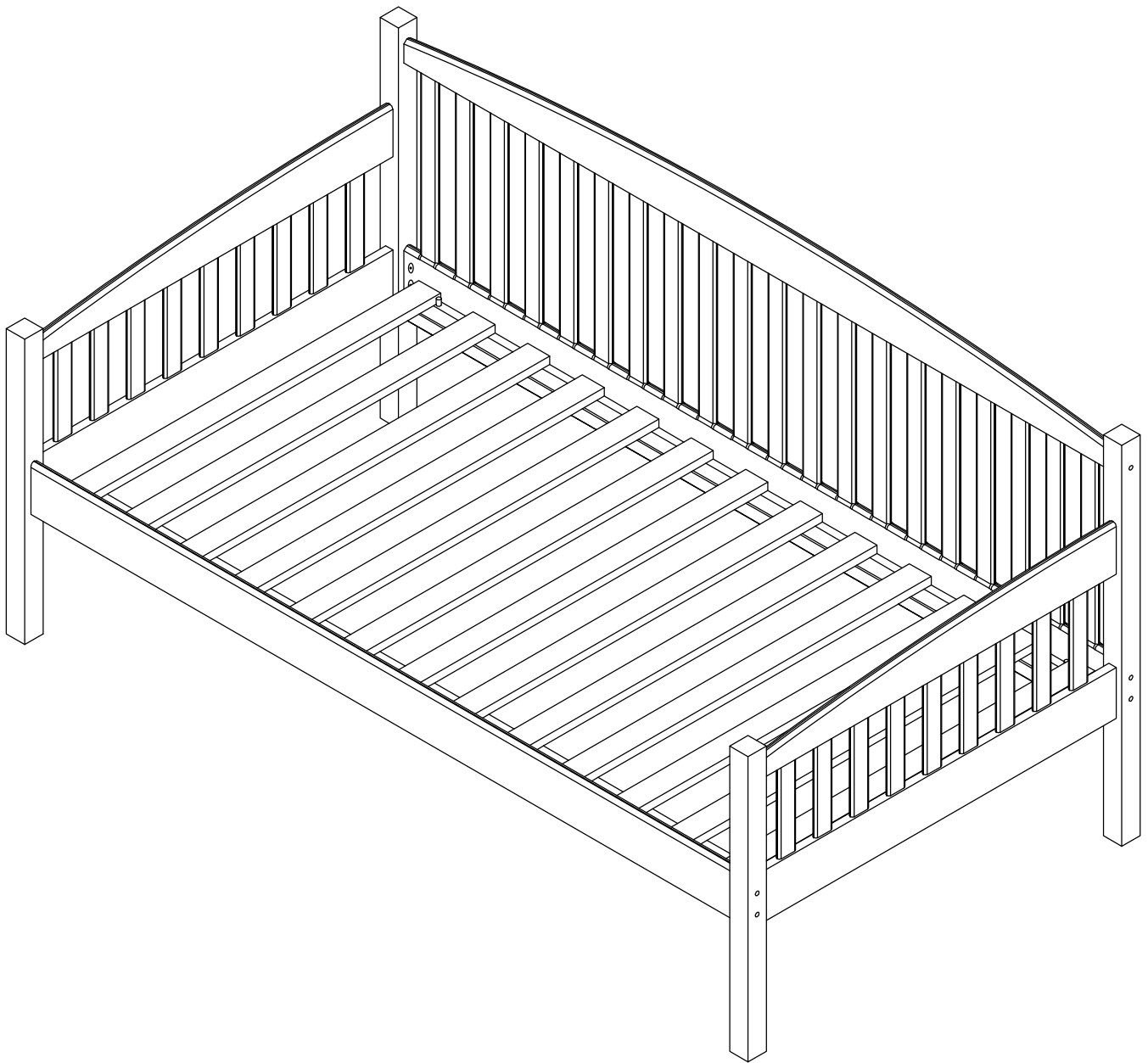



*** Thank you for purchasing this quality product. Be sure to check all packing materials carefully for small parts which may have come loose inside the carton during shipment. Identify and count all parts and compare with parts list below.

*** Assemble product on a flat, soft surface such as a carpet or cloth to prevent scratching the finish. Read all instruction and study the drawings carefully before starting the assembly process.







Do not tighten screws until each step is completed.





PARTS LIST

No	Diagram	Description	Q'ty
1		Right Hedboard	1 pc
2		Left Headboard	1 pc
3		Back Rail Pannel	1 pc
4		Front Rail	1 pc
5		Slats (13pcs=1set)	1 set

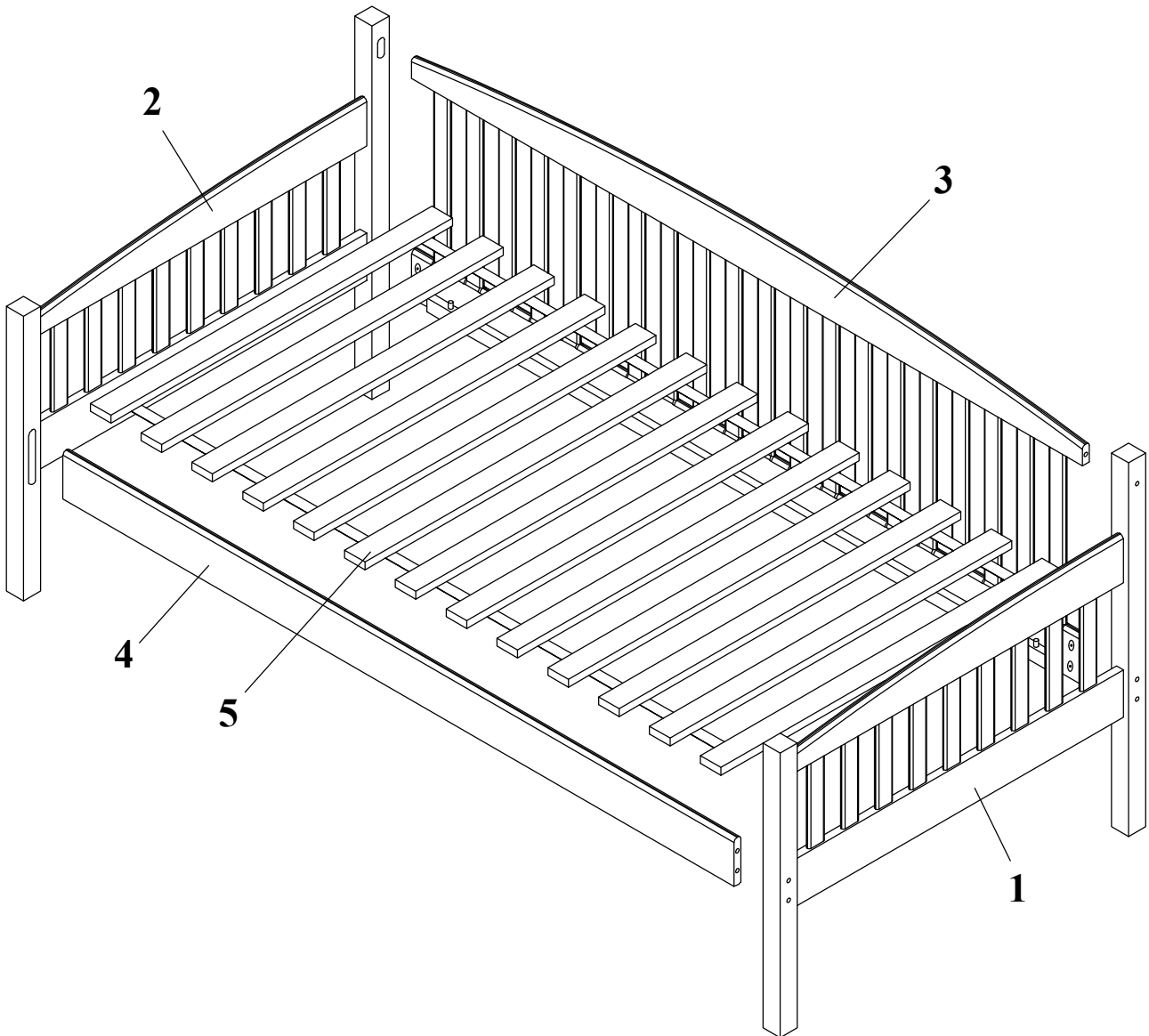
HARDWARE LIST

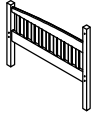
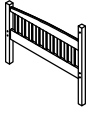
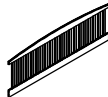
No	Diagram	Description	Q'ty
A		Bolt - 6.3 x 100(mm)	10 pcs
B		Half Round Nut	10 pcs
C		Screw - 4 x 30(mm)	26 pcs
D		Allen Wrench	1 pc

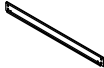
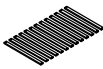

Carton	Disignation	Part		Hardware
Item: HF	Right Hedboard x 1pc	#1		
	Left Headboard x 1pc	#2		
Item: RL	Back Rail Pannel x 1pc	#3		 A: Bolt - 6.3 x 100(mm) x 10pcs  B: Half Round Nut x 10pcs  C: Screw - 4 x 30(mm) x 26pcs  D: Allen Wrench x 1pc
	Front Rail x 1pc	#4		
	Slats (13pcs=1set) x 2pcs	#5		

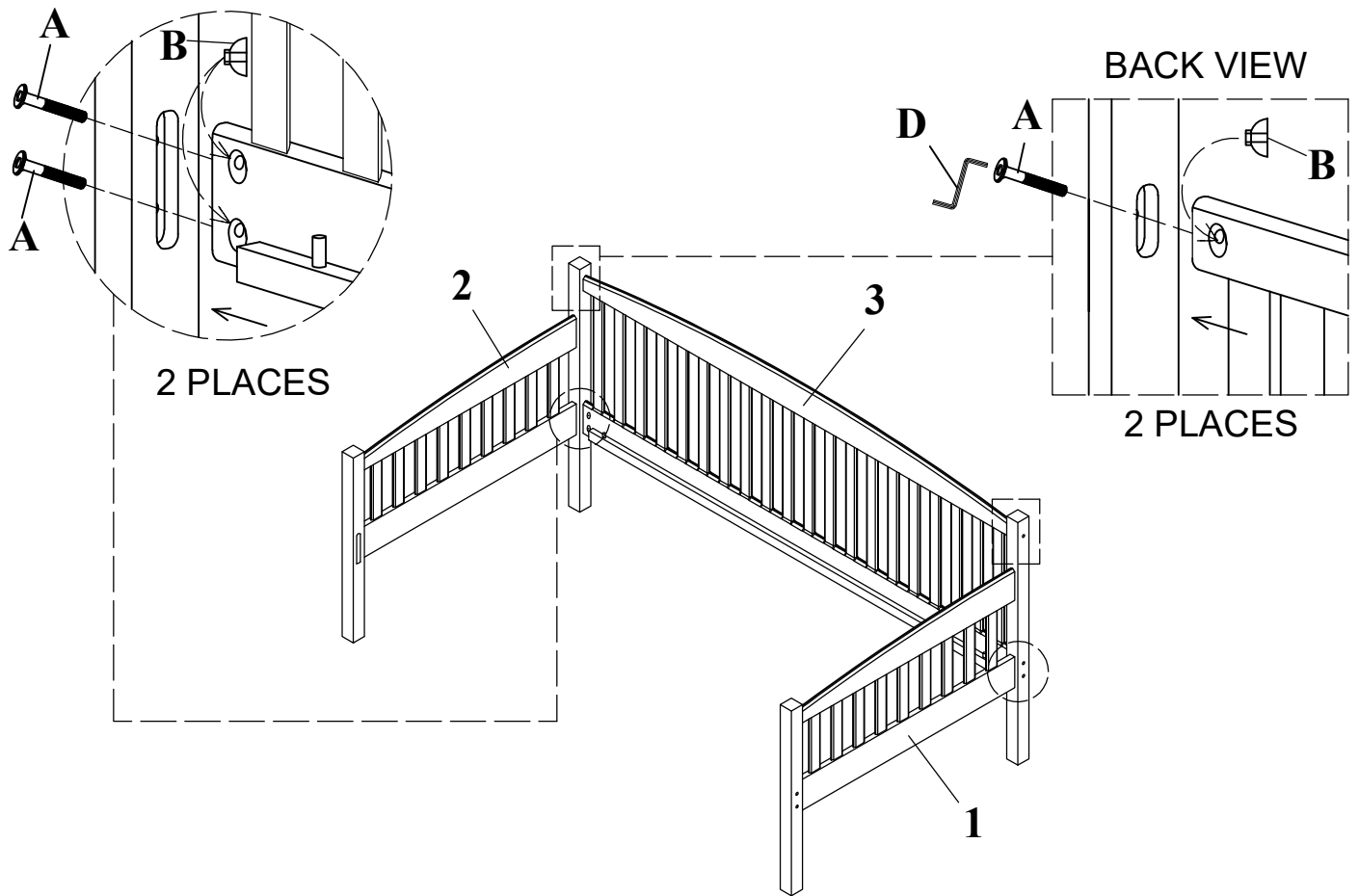

STEP 1: Left & Right Headboard Assembly With Back Panel

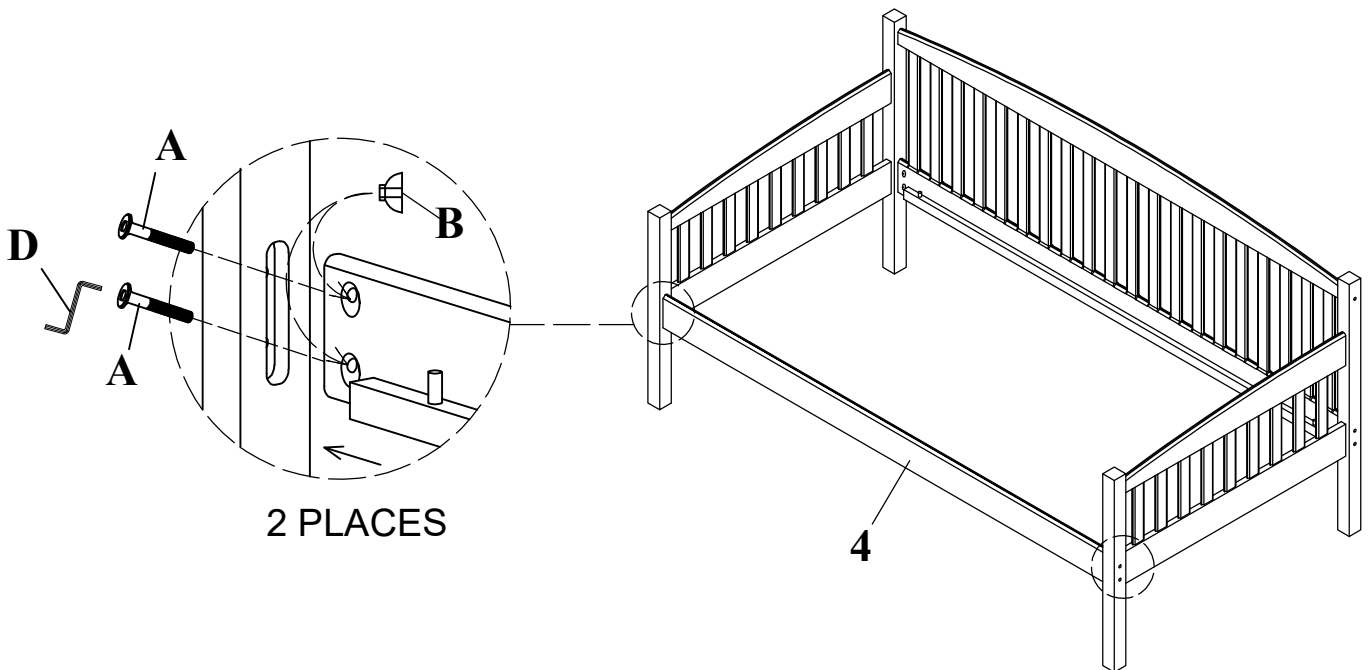

STEP 2: Front Rail Assembly

