

Model: LV-H132

# levoit

Compact HEPA Air Purifier

## Questions or Concerns?

Please contact us Monday - Friday 9:00 am - 5:00 pm PST  
at [support@levoit.com](mailto:support@levoit.com) or at **(888) 726-8520**.

# THANK YOU FOR PURCHASING THE LV-H132 COMPACT HEPA AIR PURIFIER BY LEVOIT.

Should you have any questions or concerns regarding your new product, please contact us at [support@levoit.com](mailto:support@levoit.com). We hope you enjoy your new product!

## GET STYLE INSPIRATION

Find @LevoitLifestyle on social media for wellness + style inspiration. We make every space mindful and chic.

[@LevoitLifestyle](#)

[#LevoitLove](#) • [#LevoitLifestyle](#)

## TABLE OF CONTENTS

Package Contents	3
Specifications	3
Safety Information	4
Getting to Know Your Air Purifier	6
Getting Started	7
Operation	10
· General Operation	10
· Button Controls	11
Keeping Things Clean	12
· General Maintenance	12
· Checking the Air Filters	12
· When Should I Replace the Air Filters?	12
· Replacing the Air Filters	13
· Resetting the Air Purifier	15
Troubleshooting	16
Warranty Information	18
Customer Support	18

## PACKAGE CONTENTS

1 x LV-H132 Compact HEPA Air Purifier  
1 x Activated Carbon & HEPA Filter (Pre-installed)  
1 x Pre-filter (Pre-installed)  
1 x User Manual

## SPECIFICATIONS

Power Supply	AC 120V / 60Hz
Rated Power	28W
Effective Range	129 ft <sup>2</sup> (12 m <sup>2</sup> )
Operating Conditions	Temperature: 14°F~104°F (-10°C~40°C)
Noise Level	≤ 50dB
Standby Power	< 0.8W

# SAFETY INFORMATION

**IMPORTANT:** Please read and comply with all of the instructions and warnings provided in this manual before using the product. Failure to comply with the instructions and warnings provided herein may result in inaccurate results and/or damage to the product itself.

## General Safety

**Only use this air purifier as described in this manual.**

- Ensure the plug fits properly into a polarized power outlet.
- When not being used, turn the air purifier off and disconnect it from its power source by removing the plug from the electrical outlet.
- **DO NOT** operate the unit if cord or plug is damaged. Doing so may result in injury or damage to the unit.
- **DO NOT** handle the unit with wet hands. Thoroughly dry your hands before handling any part of the air purifier.
- **DO NOT** immerse air purifier in water or liquids. Doing so may result in damage to the appliance, electric shock, or fire.
- **DO NOT** use the air purifier in wet or humid environments.
- **DO NOT** use the air purifier outdoors. This appliance is designed for indoor use only.
- **DO NOT** use the purifier in a room with major indoor temperature changes as this may cause condensation to build up inside the appliance.
- **DO NOT** use the air purifier in an enclosed space where flammable, combustible or explosive gases are present.
- **DO NOT** use in an area where toxic vapors, flammable dust or oxygen tanks are present.
- It is important to keep all objects away from the air intake grill.
- **DO NOT** insert fingers or objects into the air outlet.
- Child supervision is required while the air purifier is on. Do not allow children to play on or near the air purifier.
- **CAUTION:** This appliance does not remove carbon monoxide (CO) or radon (Rn). It cannot be used as a safety device to prevent or clean up accidents with combustion processes and hazardous chemicals.

## Use & Care

- Always make sure to place the air purifier on a flat, level surface before operation.
- Always allow 15 inches (38 cm) of clearance on all sides of the purifier.
- **WARNING:** To reduce the risk of fire or electric shock, do not use the appliance with any solid-state speed control device.
- Place the air purifier so that the power cord easily reaches a standard electrical outlet for a polarized plug.
- **DO NOT** run the power cord under carpeting. Do not cover cord with throw rugs, runners or similar coverings.  
**DO NOT ROUTE CORD UNDER FURNITURE OR APPLIANCES.** Place the power cord away from high-traffic areas.
- **DO NOT** use an extension cord with this unit.
- Never place the unit on soft surfaces such as a bed or sofa.
- This air purifier should not be used as a substitute for kitchen or bathroom ventilation or vacuum cleaning.
- **DO NOT** sit on or place anything on top of the purifier
- **DO NOT** place the purifier directly below an air conditioner to prevent any moisture from getting into the purifier.
- **DO NOT** place the air purifier near sources of heat, such as stove tops, ovens, radiators or computers.
- **DO NOT** place open flames, including candles, directly in front of the air purifier.
- **DO NOT** use this appliance with indoor smoke-type insect repellents or in places with oily residues, burning incense, or chemical fumes.
- This appliance should only be used in rooms with temperatures between 14°F and 104°F.
- Always unplug the appliance from the power supply before servicing.

- This unit should be inspected frequently. Dirt that has collected should be removed regularly to prevent excessive accumulation that may result in flashover or fire.
- **DO NOT** clean the appliance with water or any other liquid to avoid electric shock and/or electrical fires.
- Only use Levoit LV-H132-RF replacement filters for this unit. Do not attempt to use other filters with this appliance.
- If you experience any problems while operating the air purifier, refer to the **Troubleshooting** section on page 16. If you are still having problems with your air purifier, contact Customer Support on page 18.
- If the unit is damaged or is not functioning properly, immediately discontinue use and contact Customer Support (page 18).
- **DO NOT** attempt to repair this device in any way or use any replacement components or parts to modify the air purifier. Doing so will void your warranty. Contact Customer Support immediately if your appliance is no longer working.

**SAVE THESE INSTRUCTIONS**

# GETTING TO KNOW YOUR AIR PURIFIER

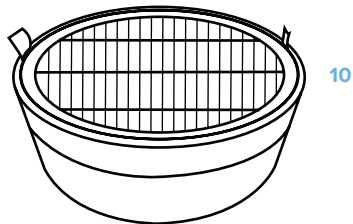
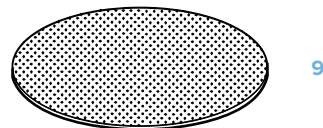
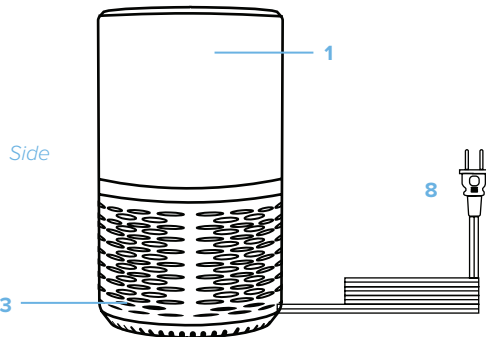
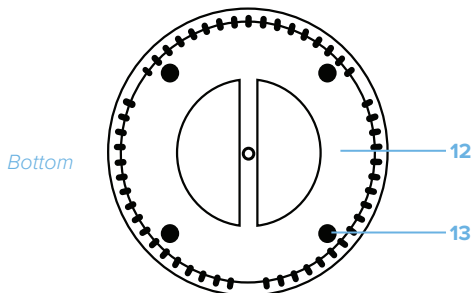
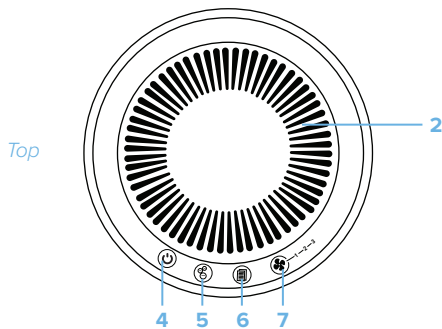

Top view of filter

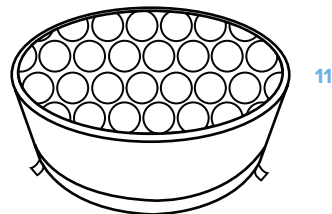

Bottom view of filter

- |                        |                             |
|------------------------|-----------------------------|
| 1. Housing             | 8. Power Cord               |
| 2. Air Outlet          | 9. Pre-Filter               |
| 3. Air Inlet           | 10. HEPA Filter             |
| 4. Power Button        | 11. Activated Carbon Filter |
| 5. Night Light Button  | 12. Filter Cover            |
| 6. Filter Reset Button | 13. Anti-Skid Pads          |
| 7. Fan Speed Button    |                             |

# GETTING STARTED

1. Flip over the purifier to reveal the filter cover.
2. Twist the filter cover counterclockwise to the "OPEN" position and remove the cover. [Figure 1.1]

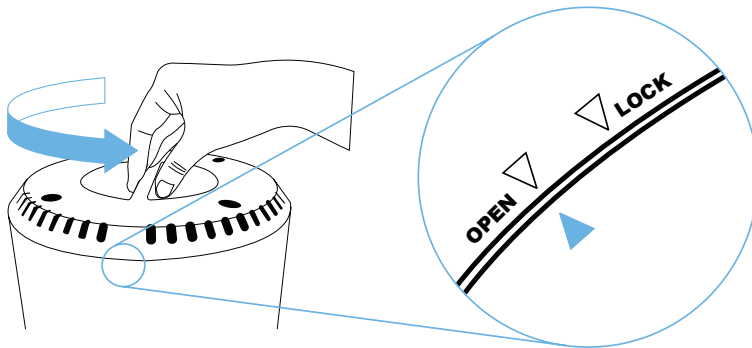

Figure 1.1

3. Remove the filters from their plastic packaging, then reinstall the filters. The white HEPA filter along with the pull tabs should be facing outward. Place the pre-filter on top of the HEPA filter. [Figures 1.2 & 1.3]

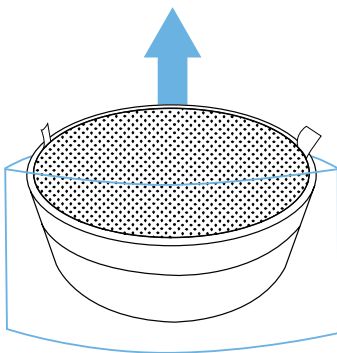

Figure 1.2

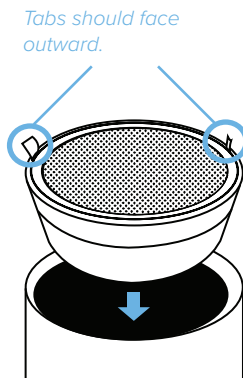

Figure 1.3

## GETTING STARTED (cont.)

4. Replace the filter cover on the air purifier, making sure the arrows on the housing and filter cover align. Twist the filter cover clockwise to the "LOCK" position to secure the filters. The filter cover should snap shut. *[Figure 1.4]*

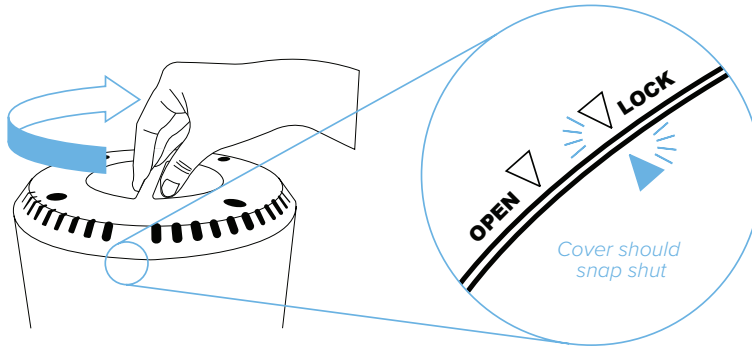

Figure 1.4

5. Place the air purifier on a flat, stable surface with the night light facing up. *[Figure 1.5]*

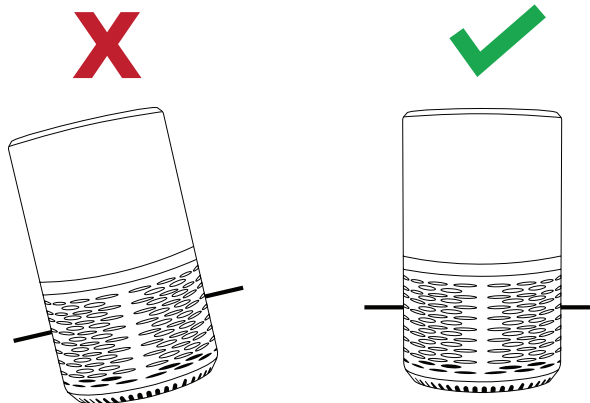

Figure 1.5



**NOTE:**

- Always allow 15 inches of clearance on all sides of the purifier. [Figure 1.6]
- Ensure the air filter is properly positioned in the purifier before use.

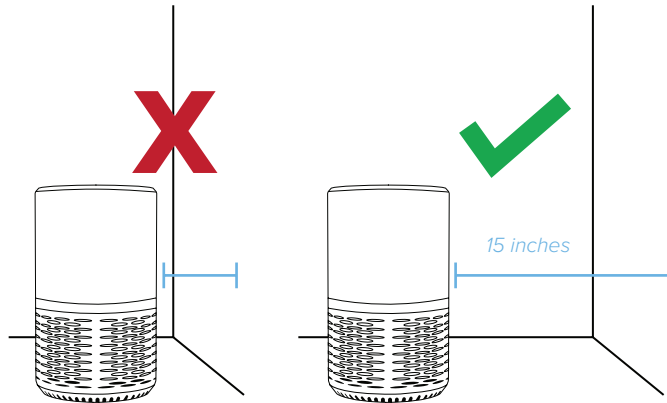





Figure 1.6

# OPERATION

## General Operation

1. Plug the air purifier into a powered electrical outlet. The unit will chime to indicate that it is connected to a power source.
2. Tap '  ' to turn on the air purifier. It will start producing fresh air on fan speed level 2.
3. (Optional): Tap '  ' to change the fan speed of the air purifier.
4. (Optional): Tap '  ' to adjust the brightness or turn off the built-in night light.
5. Tap '  ' to turn off the air purifier once you are finished using the air purifier.

**NOTE:** *It may seem that the airflow is restricted at certain portions of the air purifier when it is operating. This is normal.*

## Button Controls



### Power Button

Tap once to turn on or turn off the air purifier.



### Night Light Button

Activates the night light for the air purifier.

Chart A

Night Light Operation	
Action	Function
Tap once.	Turns on night light
Tap a second time.	Dims the night light.
Tap a third time.	Turns off the night light.
Tap and hold.	Turns off all of the lights on the air purifier. Tap any button except '🔌' to turn the lights back on. <b>NOTE:</b> Only the button lights will turn back on. The night light will remain off until '💡' is tapped once more.



### Filter Reset Button

This button will light up when the air filters need to be checked or replaced. Tap and hold '📄' for 3 seconds after checking or changing the air filters (See **Checking the Air Filters** on page 12).



### Fan Speed Button

Tap '🌀' to cycle through the 3 fan speeds of the air purifier.

#### NOTE:

- To effectively clean the air, make sure to keep the windows closed while the air purifier is operating. Open the windows regularly to maintain proper air circulation throughout your home.
- For best results, it is recommended to run the air purifier at maximum speed for 15–20 minutes before using a lower speed setting or setting the purifier to auto mode.

## Memory Function

The air purifier will remember its programmed settings when turned off. This includes fan speed and night light brightness level. The purifier will resume its settings when it is turned back on.



# KEEPING THINGS CLEAN

## General Maintenance

- Wipe down the housing with a soft, clean cloth.
- **DO NOT** immerse the purifier in water or liquid detergents.
- If necessary, wipe the housing with a clean damp cloth, then immediately dry the housing with a separate clean cloth.

## Checking the Air Filters

The '  ' will light up to remind you to check the air filters. Please note, this is simply a reminder to **check** the air filters. The button will light up on sooner or later depending on how often you use your air purifier. It does not necessarily mean it is time to change the filters.

If '  ' has illuminated, please remember to reset the air purifier after checking the filters by tapping and holding '  ' for 3 seconds (See **Resetting the Air Purifier** see page 15).

## When Should I Replace the Air Filters?

It is recommended to change the air filters every 6–8 months. However, you may need to change your filters sooner or later depending on how often you use your air purifier. It is important to watch out for the following signs of expired filters:

- Increased operating noise
- Decreased airflow
- Clogged filters
- Increased presence of odors

### **NOTE:**

- *The environment in which the air purifier being used may also extend or shorten the lifetime of the the air filters. Using your air purifier in an environment of relatively high pollution may mean you will need to change the air filters more often.*
- *If the air pollution in your environment is very high, there is a possibility that the filters may not be completely effective and may need to be replaced before '  ' lights up.*
- *Remember to reset the air purifier after changing the air filters.*

## Replacing the Air Filters

1. Turn off and unplug the air purifier.
2. Flip over the purifier and remove the filter cover. [Figure 2.1 & 2.2]

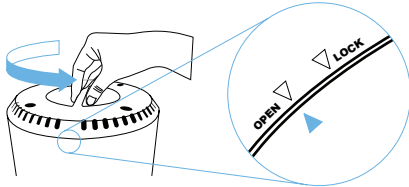

Figure 2.1

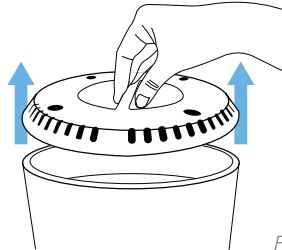

Figure 2.2

3. Remove the old filters. [Figure 2.3]
4. (Optional) Clean any remaining dust or hair inside the purifier using a vacuum hose [Figure 2.4]. DO NOT use water or liquids to clean the purifier.

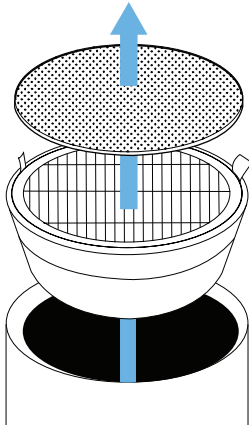

Figure 2.3



Figure 2.4

## Replacing the Air Filters (cont.)

- Remove the new filters from their packaging and place them into the purifier with the pull tabs facing out. The white HEPA filter should also be facing out with the gray pre-filter on top of it. [Figures 2.5 & 2.6]

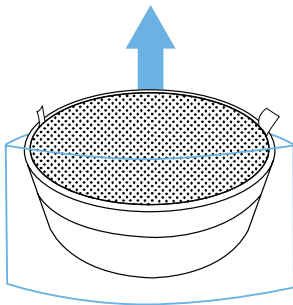

Figure 2.5

*Tabs should face the opening.*

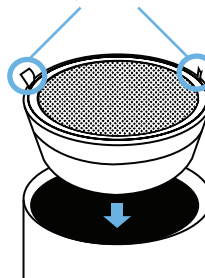

Figure 2.6

- Replace the filter cover onto the housing, making sure the arrows on the housing and filter cover align. Turn the filter cover clockwise to the lock position. [Figures 2.7 & 2.8]
- Follow the instructions in the **Resetting the Air Purifier** on page 15 to complete the filter replacement process.

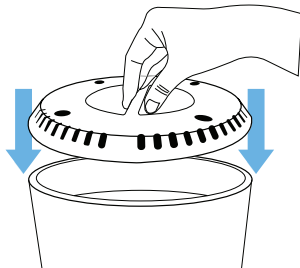

Figure 2.7

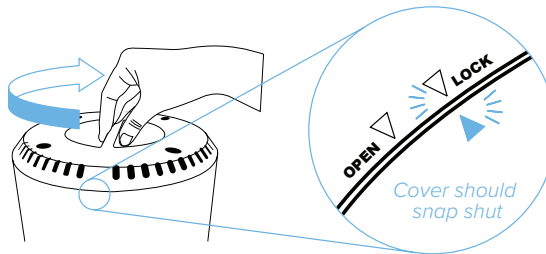

Figure 2.8



**NOTE:**

- **DO NOT** wash and reuse air filters. The air filters cannot be cleaned manually.
- Only use **Levoit LV-H132-RF True HEPA Filters** when changing the filter for this device.
- Scan the QR Code to the right to purchase new air filters.





## Resetting the Air Purifier

The air purifier must be reset if '  ' lights up, and after checking or replacing the air filters.



1. Plug in the air purifier and turn it on.
2. Press and hold '  ' for 3 seconds.
3. Release '  ' and the light will turn off, indicating that the reset is complete.

## Performing a Hard Reset

When using the air purifier in an environment of heavy pollution, the lifespan of the air filters may be significantly reduced. You can change the filters even if '  ' does not light up. Follow the steps below to perform a hard reset.

1. Replace the air filters as mentioned in the Replacing the Air Filters section on page 13.
2. Plug in the air purifier and turn it on.
3. Press and hold '  ' for 3 seconds, and it will light up.
4. Press and hold '  ' again for 3 seconds, and it will **turn off**. The reset is now complete.

# TROUBLESHOOTING

Problem	Cause	Solution
Air purifier does not power on.	Unit is not plugged into an electrical outlet.	Connect the plug to a powered electrical outlet.
	Outlet is not working properly.	Try plugging the air purifier into a different outlet.
	Power button has not been pressed after plugging in the air purifier.	Press '  ' once to turn on the air purifier.
	Power cord is damaged.	Immediately discontinue use and contact Customer Support (page 18).
	Air purifier is defective or malfunctioning.	
Air purifier does not respond to button controls.	Air purifier is not plugged into an outlet.	Connect the plug to a powered electrical outlet.
	Air purifier is defective or malfunctioning.	Immediately discontinue use and contact Customer Support (page 18).
Air purifier makes an unusual noise while operating.	Air filters are dirty.	Replace the air filters as instructed in the <b>Replacing the Air Filters</b> section on page 13.
	Filter does not fit properly.	Properly place filter(s) as noted in the <b>Getting Started</b> and <b>Replacing the Air Filters</b> sections (pages 8 and 13).
	Foreign object inside the unit.	Immediately discontinue use and contact Customer Support (page 18). <b>DO NOT</b> attempt to open the air purifier.
Significantly reduced airflow.	Filter packaging has not been removed.	Remove filter from packaging before use.
	Fan speed is low.	Press '  ' to adjust fan speed.
	Air filters need to be replaced.	Replace the air filters as instructed in the <b>Replacing the Air Filters</b> section on page 13.
	Not enough clearance on all sides of the purifier.	Ensure there is at least 15 inches (38 cm) of clearance on all sides of the purifier.



Problem	Cause	Solution
<p>Poor air purification quality.</p>	<p>Air filters need to be replaced.</p>	<p>Replace the air filters as instructed in the <b>Replacing the Air Filters</b> section on page 13.</p>
	<p>Room is too large for the air purifier's applicable area.</p>	<p>Ensure the room is smaller than 129 ft<sup>2</sup> (12 m<sup>2</sup>).</p>
	<p>Air inlet or outlet is blocked.</p>	<p>Remove objects blocking air inlet or outlet.</p>
	<p>Filters not properly placed in housing.</p>	<p>Properly place filters as noted in the <b>Getting Started</b> and <b>Replacing the Air Filters</b> sections (pages 8 &amp; 13).</p>
<p>Filter reset button is still illuminated after replacing the air filters.</p>	<p>The air purifier has been reset incorrectly.</p>	<p>See the <b>Resetting the Air Purifier</b> section on how to properly reset the unit (page 15).</p>
<p>Air purifier turns on, then suddenly turns off.</p> <p>Air purifier beeps repeatedly after being powered on or plugged in.</p>	<p>Air purifier is defective or malfunctioning.</p>	<p>Immediately discontinue use and contact Customer Support (page 18). <b>DO NOT</b> attempt to open the air purifier for self-servicing.</p>

# WARRANTY INFORMATION

<b>Product Name</b>	Compact HEPA Air Purifier
<b>Model Number</b>	LV-H132
<b>Default Warranty Period</b>	1 Year(s)
<i>For your own reference, we strongly recommend that you record your order number and date of purchase.</i>	
<b>Date of Purchase</b>	
<b>Order Number</b>	

## TERMS & POLICY

Levoit warrants all products to be of the highest quality in material, craftsmanship, and service, effective starting from the date of purchase.

Levoit will replace any product found to be defective due to manufacturer flaws based on eligibility. Refunds are available within the first 30 days of purchase. Refunds are only available to the original purchaser of the product. This warranty extends only to personal use and does not extend to any product that has been used for commercial, rental, or any other use in which the product is not intended for. There are no warranties other than the warranties expressly set forth with each product.

This warranty is non-transferrable. Levoit is not responsible in any way for any damages, losses or inconveniences caused by equipment failure or by user negligence, abuse, or use noncompliant with the user manual or any additional safety, use, or warnings included in the product packaging and manual.

### **This warranty does not apply to the following:**

- Damage due to abuse, accident, alteration, misuse, tampering or vandalism.
- Improper or inadequate maintenance.
- Damage in return transit.
- Unsupervised use by children under 18 years of age.

Levoit and its subsidiaries assume no liability for damage caused by the use of the product other than for its intended use or as instructed in the user manual. Some states do not allow this exclusion or limitation of incidental or consequential losses so the foregoing disclaimer may not apply to you. This warranty gives you specific legal rights and you may also have other rights which may vary from state to state.

**ALL EXPRESSED AND IMPLIED WARRANTIES, INCLUDING THE WARRANTY OF MERCHANTABILITY, ARE LIMITED TO THE PERIOD OF THE LIMITED WARRANTY.**

### **Additional 1-Year Warranty**

You can extend your one-year warranty by an additional year. Log onto [www.levoit.com/warranty](http://www.levoit.com/warranty) and enter your order number (i.e. Amazon or Houzz) within the first 14 days of purchase to register your new product for the extended warranty.

If you are unable to provide the order number for your product, please type a short note in the order number field along with the date you received your product.

### **Defective Products & Returns**

Should your product prove defective within the specified warranty period, please contact Customer Support via [support@levoit.com](mailto:support@levoit.com) with your invoice and order number. Once our Customer Support team has approved your request, please return the unit with a copy of your invoice and order number.

# CUSTOMER SUPPORT

Should you encounter any issues or have any questions regarding your new product, feel free to contact our helpful Customer Support Team. Your satisfaction is our goal!

## **Customer Support**

Levoit Corporation  
1202 N. Miller St., Suite A  
Anaheim, CA 92806

Email: [support@levoit.com](mailto:support@levoit.com)  
Toll-Free: (888) 726-8520

## **Support Hours**

Monday - Friday: 9:00 am - 5:00 pm PST

*\*Please have your order invoice or order number ready before contacting Customer Support.*

Connect with us @LevoitLifestyle



**lėvoit**

**Levoit.com**