

Assembly Instructions

Caution : You must read this before you proceed





67025.00LBRN



WARNING

**Choose an appropriate location for the fountain.
Excessive weight or pressure on any of the fountain sections may cause it to fall. Keep pets, children, or anyone from sitting, leaning, or climbing on any components of the fountain.
While fountain is designed to operate as splash free as possible, some water splashing out of the fountain is inevitable. Place the fountain in a location where any splashing will not cause damage.
Keep this manual for future reference.
Take out all the package parts from the carton, follow assembly the fountain as below steps**

Parts List

Label	Picture	Description	QTY
A		Fountain Body	1
B		4 LED lights	1
C		Pump	1
D		Transformer	1

Assembly Preparation

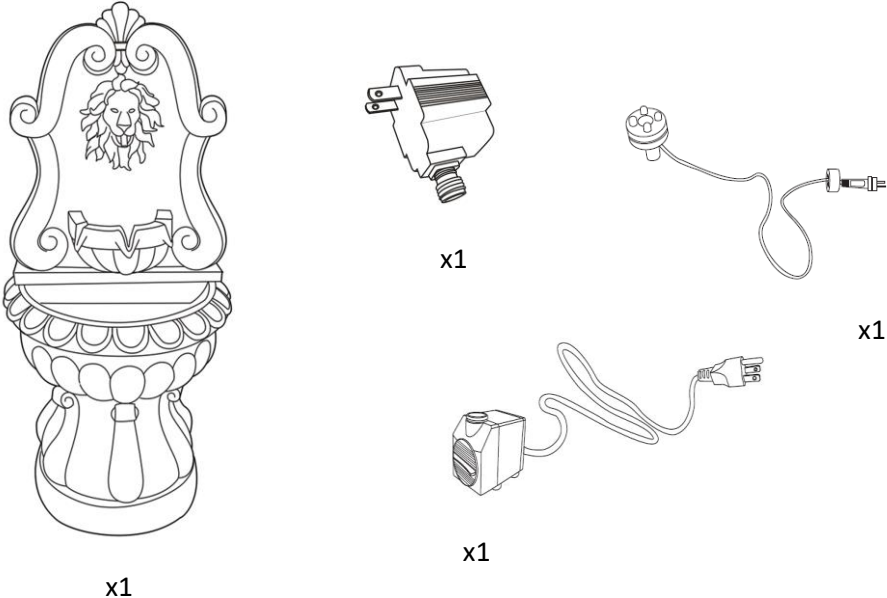
<p>Before Beginning Assembly:</p>	 <p>The diagram illustrates the components needed for assembly. On the left is the fountain body (A). To its right are the transformer (D), the 4 LED lights (B), and the pump (C). Each component is accompanied by the label 'x1'.</p>
-----------------------------------	--



- Read instructions, cover to cover-



- Have 2 adults on hand for assembly-



- Do not assemble on flooring or carpet-



- Assemble on a clean non-marring surface (packing foam)-



- Save all packaging until finished-

Assembly Steps

This Fountain has multiple parts and may require up to some minutes to assemble. Please read through the instructions below to familiarise yourself with the parts and steps before assembly.

Step 1

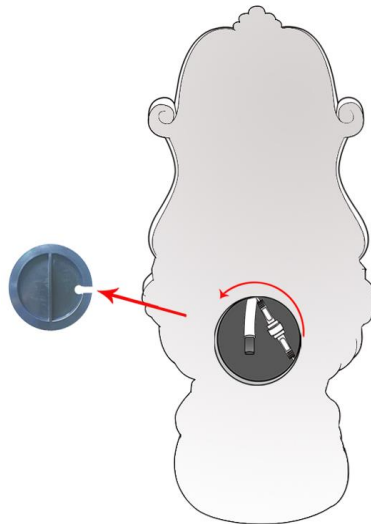

Place the Fountain Body(A) on a level surface away from areas where it is likely to get colgged with leaves and make sure that the cable will reach the socket and open the back door(anticlockwise).

Step 2

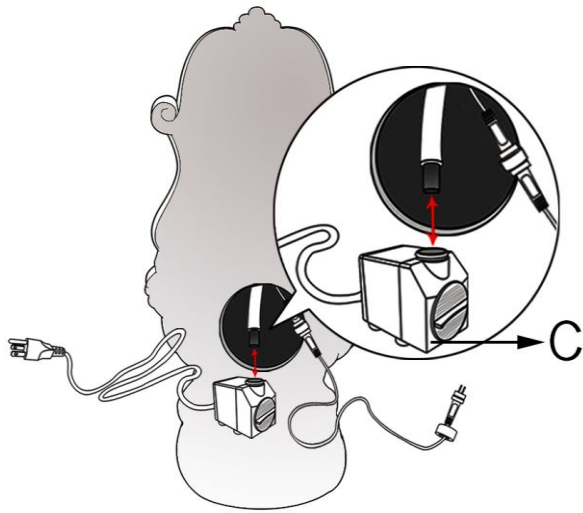

Insert water pipe into the Pump(C), showed as above.

Step 3

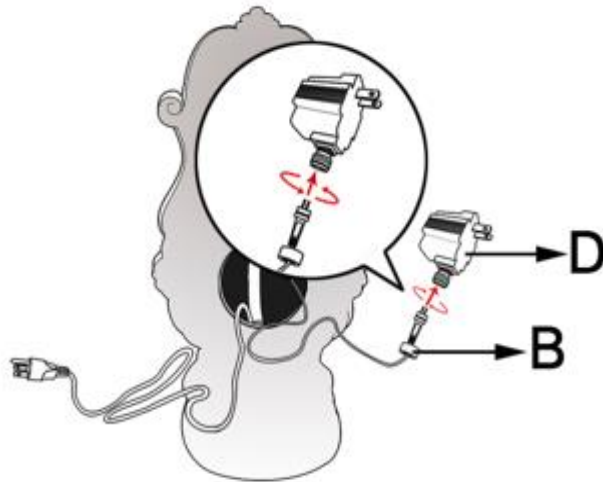

Connect the 4 LED Light(B) to Transformer(D), showed as above.

Step 4

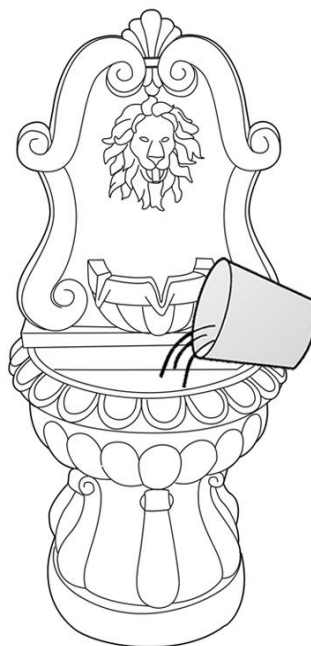

Fill the Fountain with clean water carefully, showed as above.

Step 5

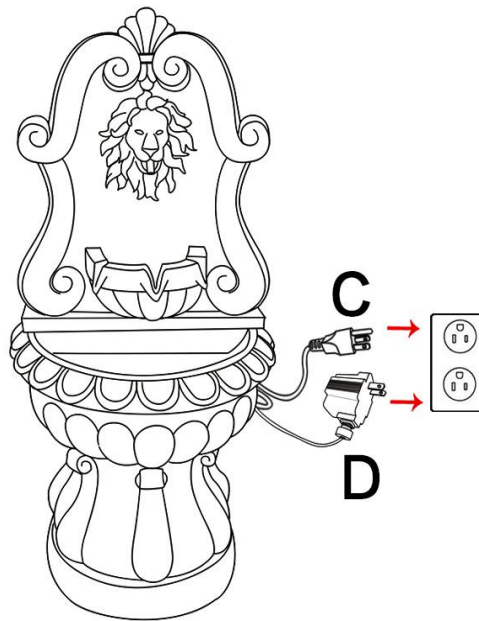

Plug the Pump(C) and Transformer(D) to the socket, showed as above. The water will start to flow in minutes.

Attention: Always make sure the water can submerge the pump completely to work properly to prevent the pump damage.



















Troubleshooting:

Turn off the power before you check following!

If pump does not run, or lights not on:

- (1) Check the circuit breaker, try another outlet.**
- (2) Check the water level in the fountain. Running the pump without sufficient water can damage the pump.**
- (3) Check the setting of the flow control on the pump and adjust the flow.**
- (4) Check the pump discharge and intake for dirt and debris.**
- (5) The pump might be "air locked", plug and unplug the pump.**
- (6) Check and reconnect all the cords and try again.**

Care & Maintenance

-   ● Do not put hot items directly on furniture surface
 -   ● Do not clean furniture with harsh cleansers or polish.
 -   ● To obtain the longest lifespan of your outdoor products, minimizing exposure to direct sunlight is recommended.
 -   ● Children should not climb or jump on the furniture.
 -   ● Do not write on furniture without a padded barrier to protect the surface.
 -   ● To obtain the longest lifespan of your outdoor products, avoid extended and lengthy exposure to rain, snow, and direct sunshine. Whenever possible cover the product and /or place under patio or awnings.
 -   ● Not for commercial use. For residential use only .
 -   ● Stains may be removed with mild soap solution and damp cloth.
-
-   ● Dust and pick-up spills using a clean, non-colored, lint-free cloth .

Questions & Answers about Proposition 65

• What is Proposition 65?

Proposition 65 requires businesses to provide warnings to Californians about significant exposures to chemicals that cause cancer, birth defects or other reproductive harm. These chemicals can be in the products that Californians purchase, in their homes or workplaces, or that are released into the environment. By requiring that this information be provided, Proposition 65 enables Californians to make informed decisions about their exposures to these chemicals.

Proposition 65 also prohibits California businesses from knowingly discharging significant amounts of listed chemicals into sources of drinking water.

Proposition 65 requires California to publish a list of chemicals known to cause cancer, birth defects or other reproductive harm. This list, which must be updated at least once a year, has grown to include approximately 900 chemicals since it was first published in 1987.

• What types of chemicals are on the Proposition 65 list?

The list contains a wide range of naturally occurring and synthetic chemicals that include additives or ingredients in pesticides, common household products, food, drugs, dyes, or solvents. Listed chemicals may also be used in manufacturing and construction, or they may be byproducts of chemical processes, such as motor vehicle exhaust.

• What does a warning mean?

If a warning is placed on a product label or posted or distributed at a workplace, a business, or in rental housing, the business issuing the warning is aware or believes that it is exposing individuals to one or more listed chemicals.

By law, a warning must be given for listed chemicals unless the exposure is low enough to pose no significant risk of cancer or is significantly below levels observed to cause birth defects or other reproductive harm.

• Where can I get more information on Proposition 65?

If you have specific questions on the administration or implementation of Proposition 65, you can contact OEHHHA's Proposition 65 program at P65.Questions@oehha.ca.gov, or by phone at (916) 445-6900.