

ASSEMBLY INSTRUCTION

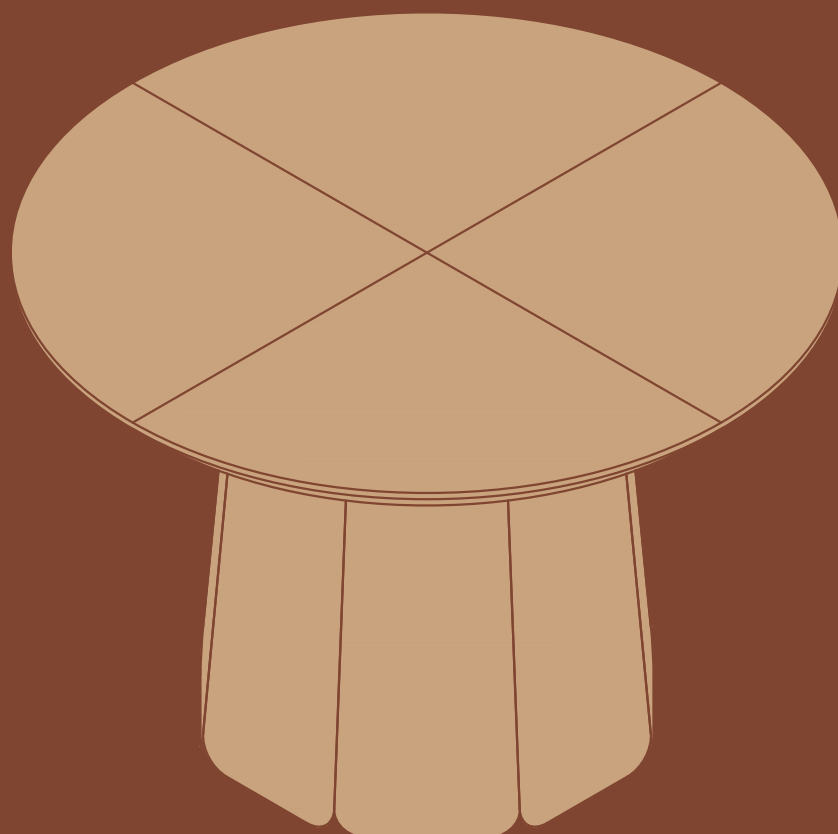

Dining Table

CATALOGUE

Precautions	01
Parts List	02
Hardware List	03
Tool List	04
Assembly Process	05-13

INTRODUCTION

Thank you for purchasing our products. Please read the instructions carefully before installation and keep it in a safe place for future reference. If you need any assistance or support, please feel free to contact our customer support team.

PRECAUTIONS

This package contains numerous components and hardware pieces. Please identify and verify all parts against the parts list before you begin assembly.

WARNING: Choking Hazard. This product contains small items. Keep all parts and hardware out of the reach of children during assembly.

To prevent scratches, assemble the product on a soft, non-abrasive surface such as a carpet, blanket, or the flattened cardboard packaging.



Some components are heavy. For safety, we recommend this product be assembled by two adults.

The unit may be unstable until assembly is fully complete. Do not move the product until all steps are finished.





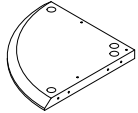

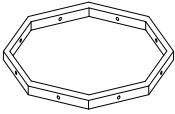
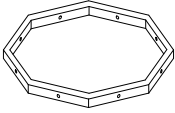
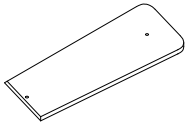



If you encounter any issues or have questions, please contact our customer service team for assistance.

- * **Please be sure to follow the installation steps in the manual to avoid unnecessary losses caused by improper installation.**
- * **If you need further assistance, please contact the customer service online.**

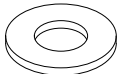
Parts List

ID	Parts	QTY
1		4
2		1
3		1
4		1
5		8

Hardware List

ID	Parts	QTY
A	 M6*32mm	28+2
B	 M6*15mm	4
C	 Ø8*30mm	8
D		4
E	 M6	32+3
F	 M8*85mm	8
G	 M8	16+1
H		16+1
I		8
J		8

Tool List

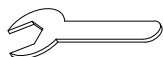
ID	Parts	QTY
Z1		1
Z2		2

Required Tools (Not Included)

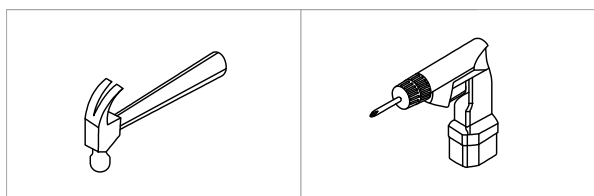

Wall mounting only

These tools are not required for product assembly.

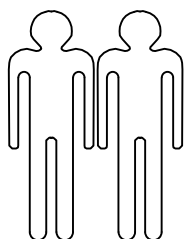

Multi-person installation

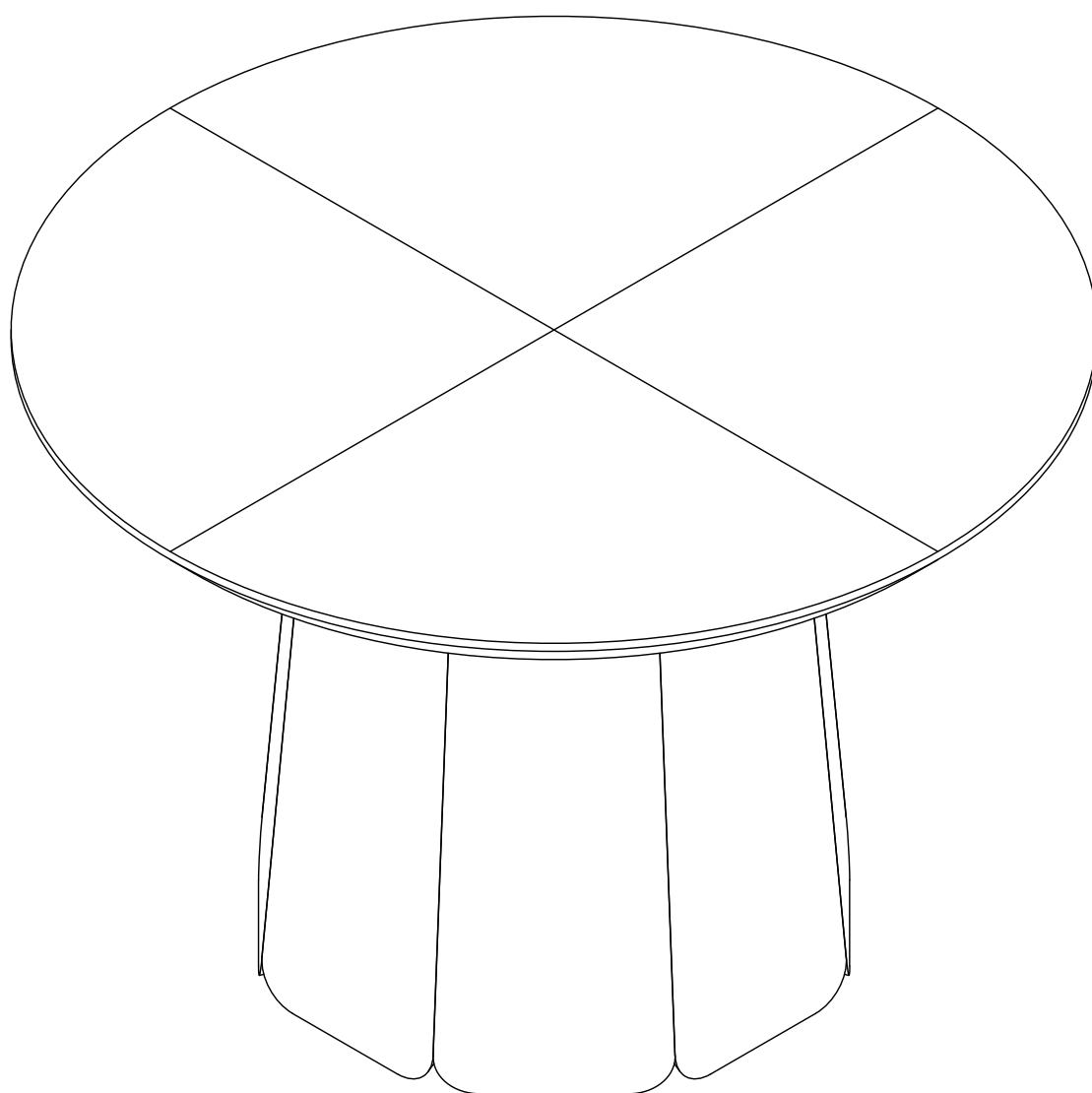

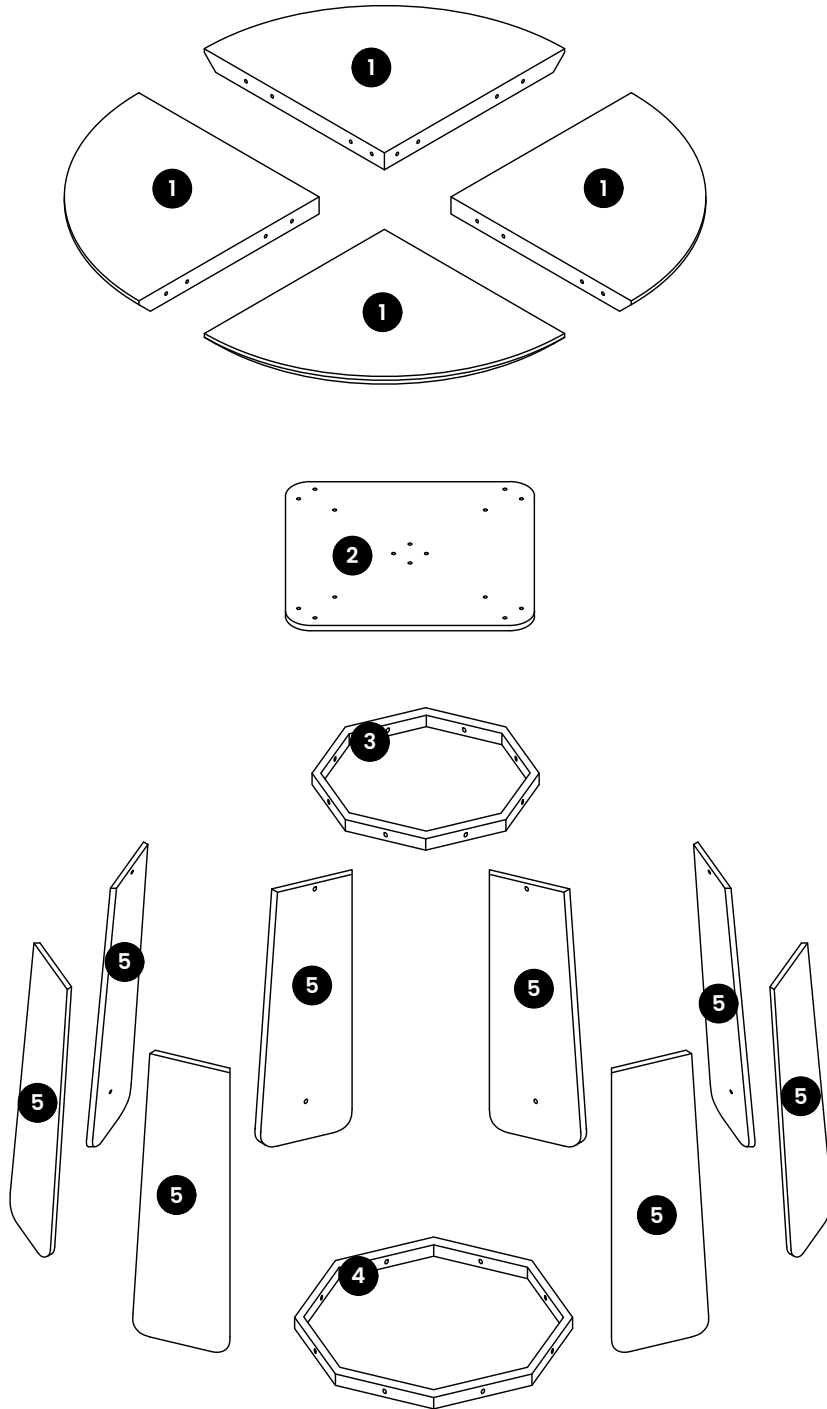

STEP 1



x2

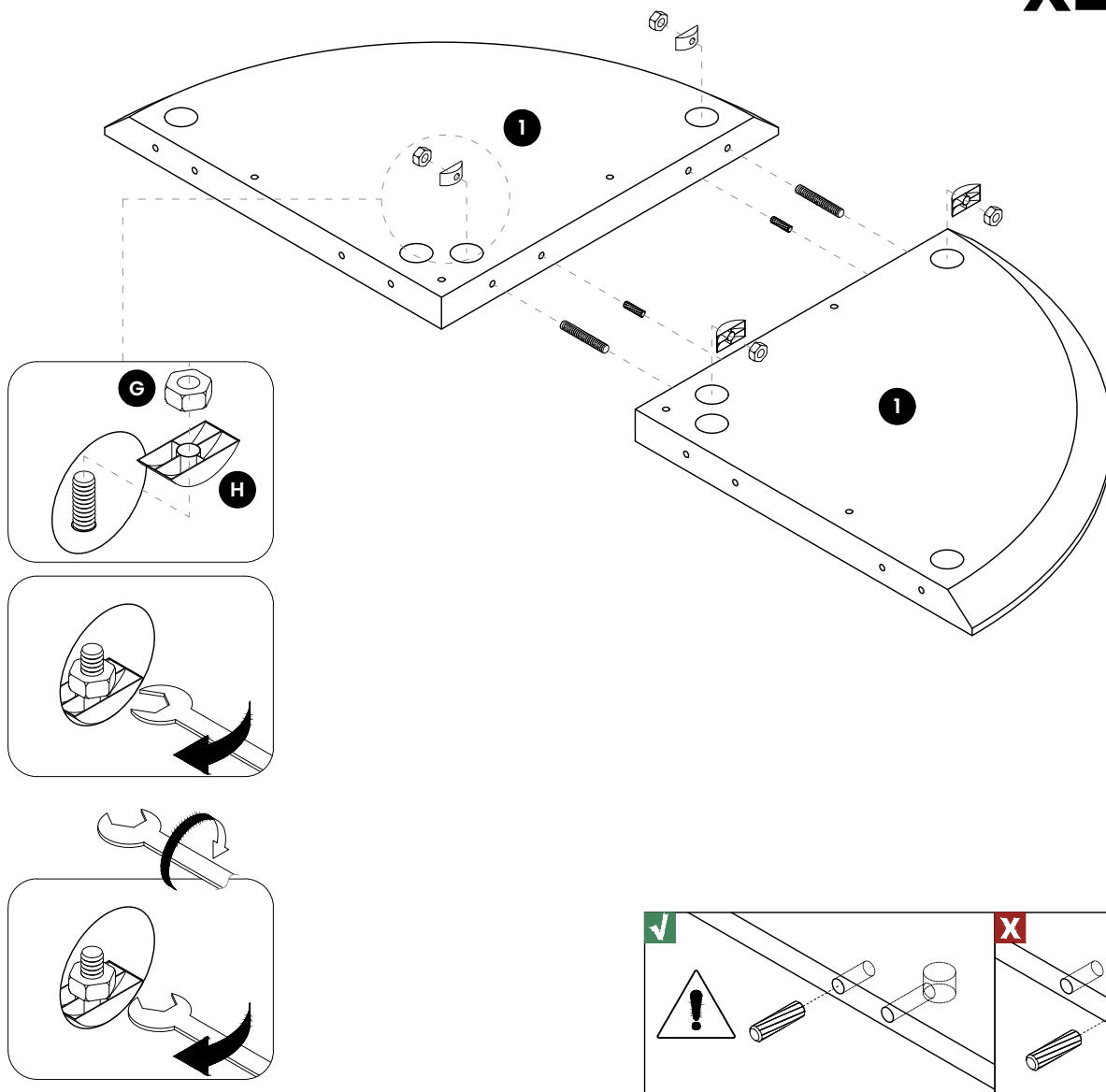

STEP 2

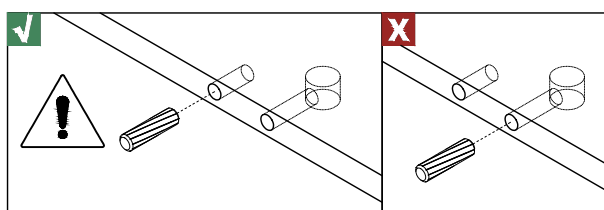
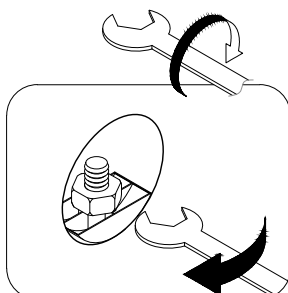
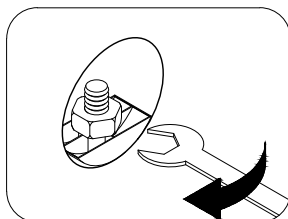
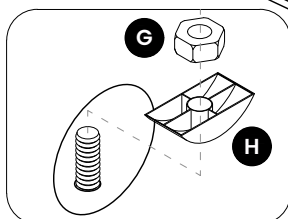
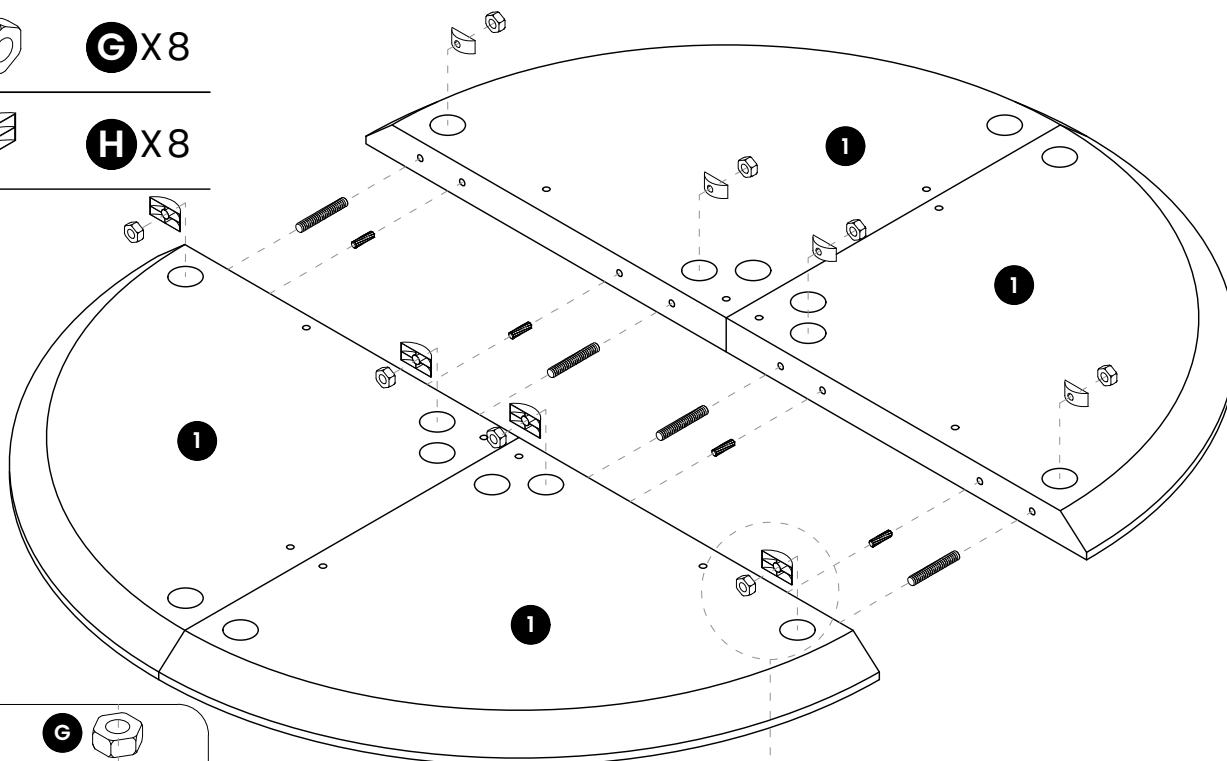

STEP 3

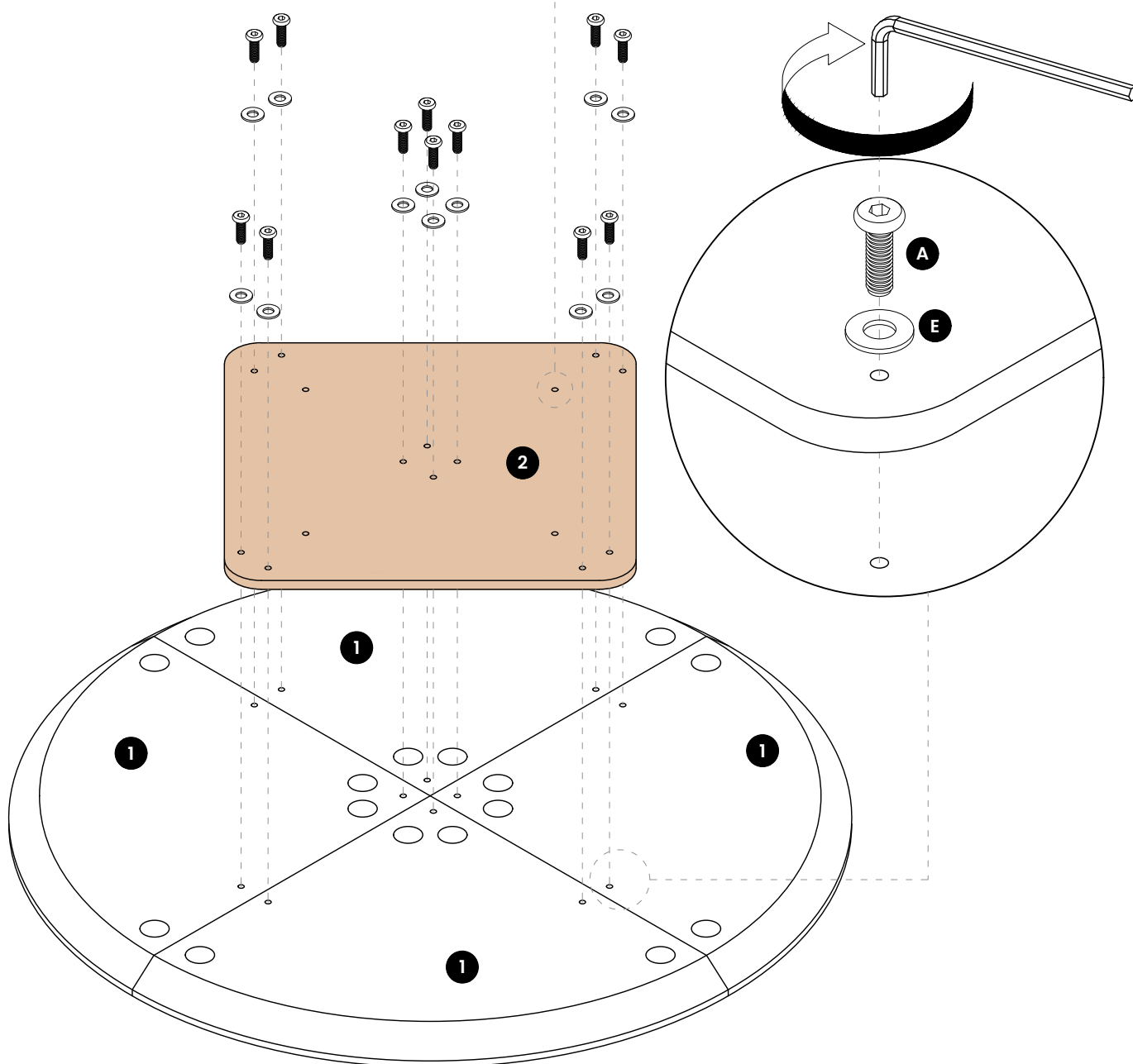
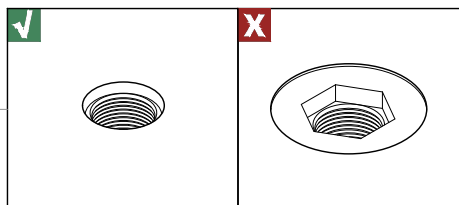

STEP 4

 **A** X8

 **D** X4

 **E** X8

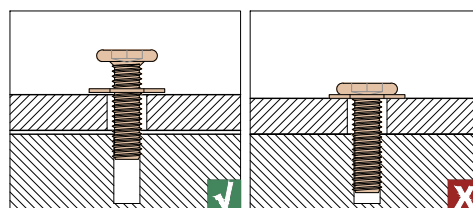
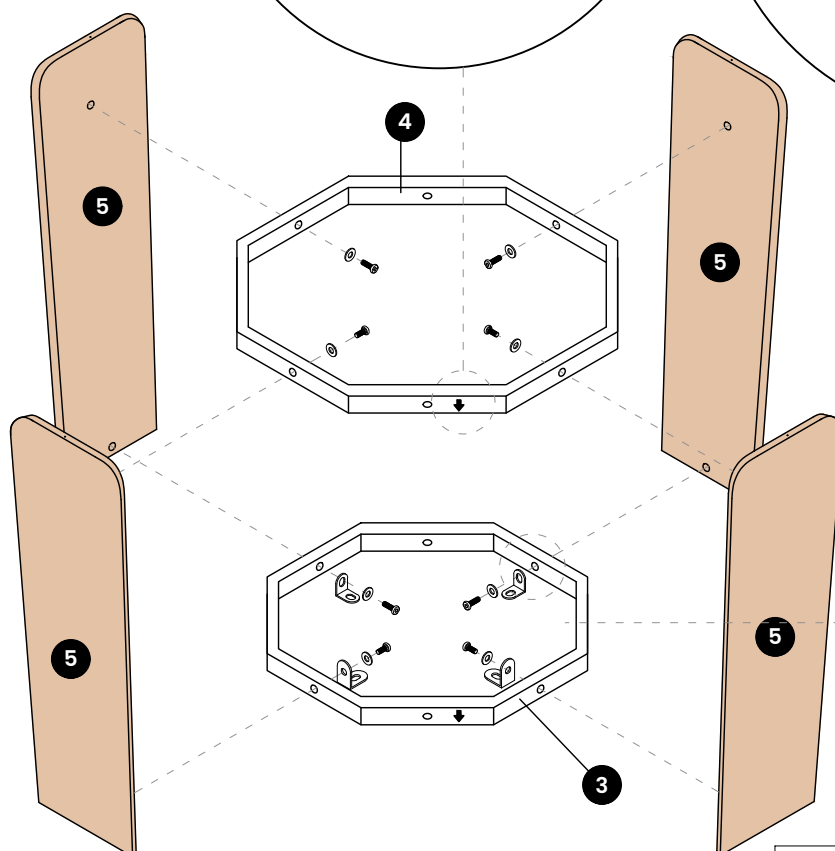
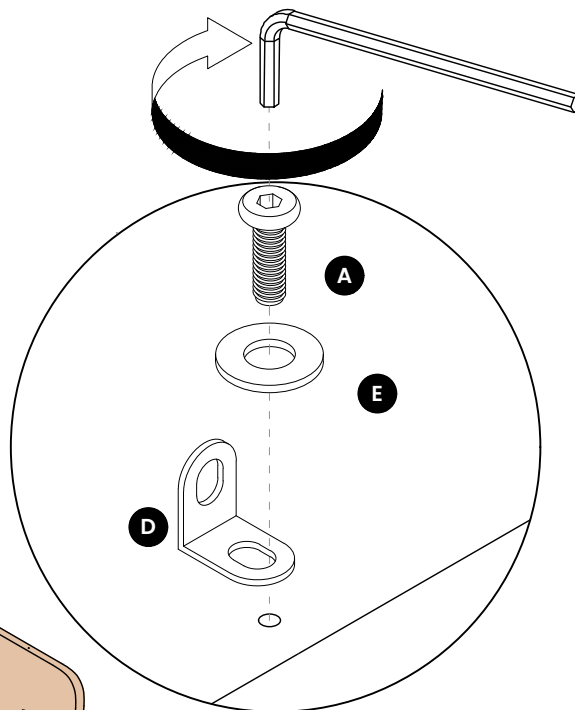
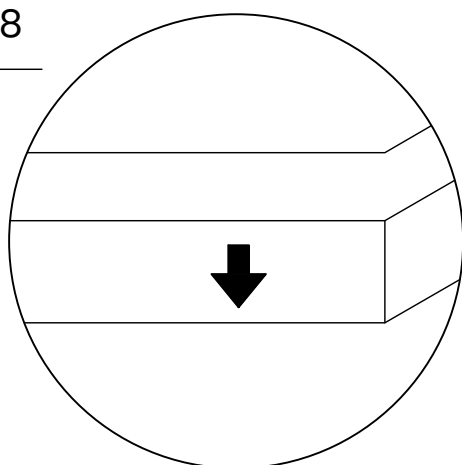

STEP 5

 **A** X8

 **E** X8

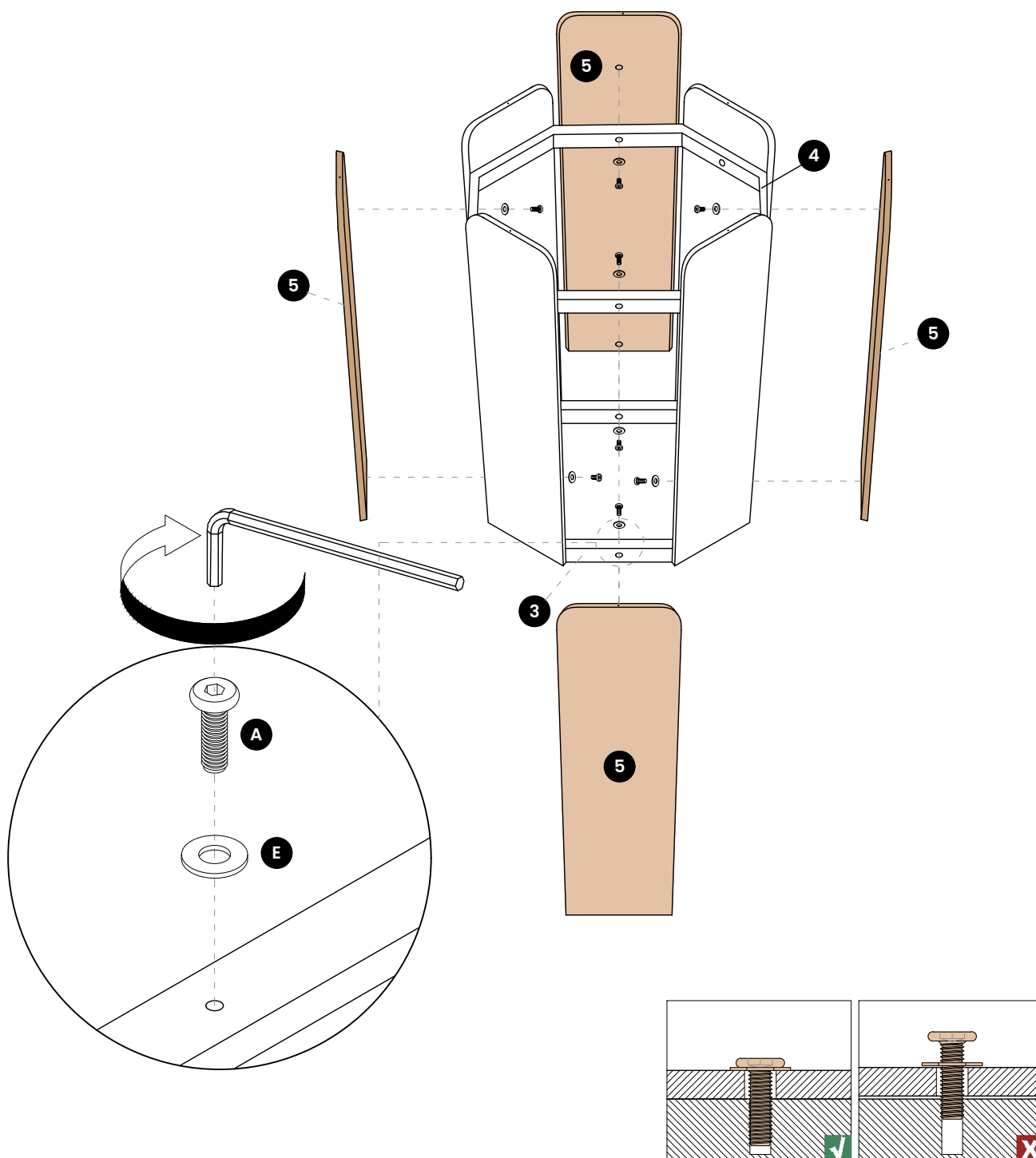

STEP 6

 **B** X4

 **E** X4

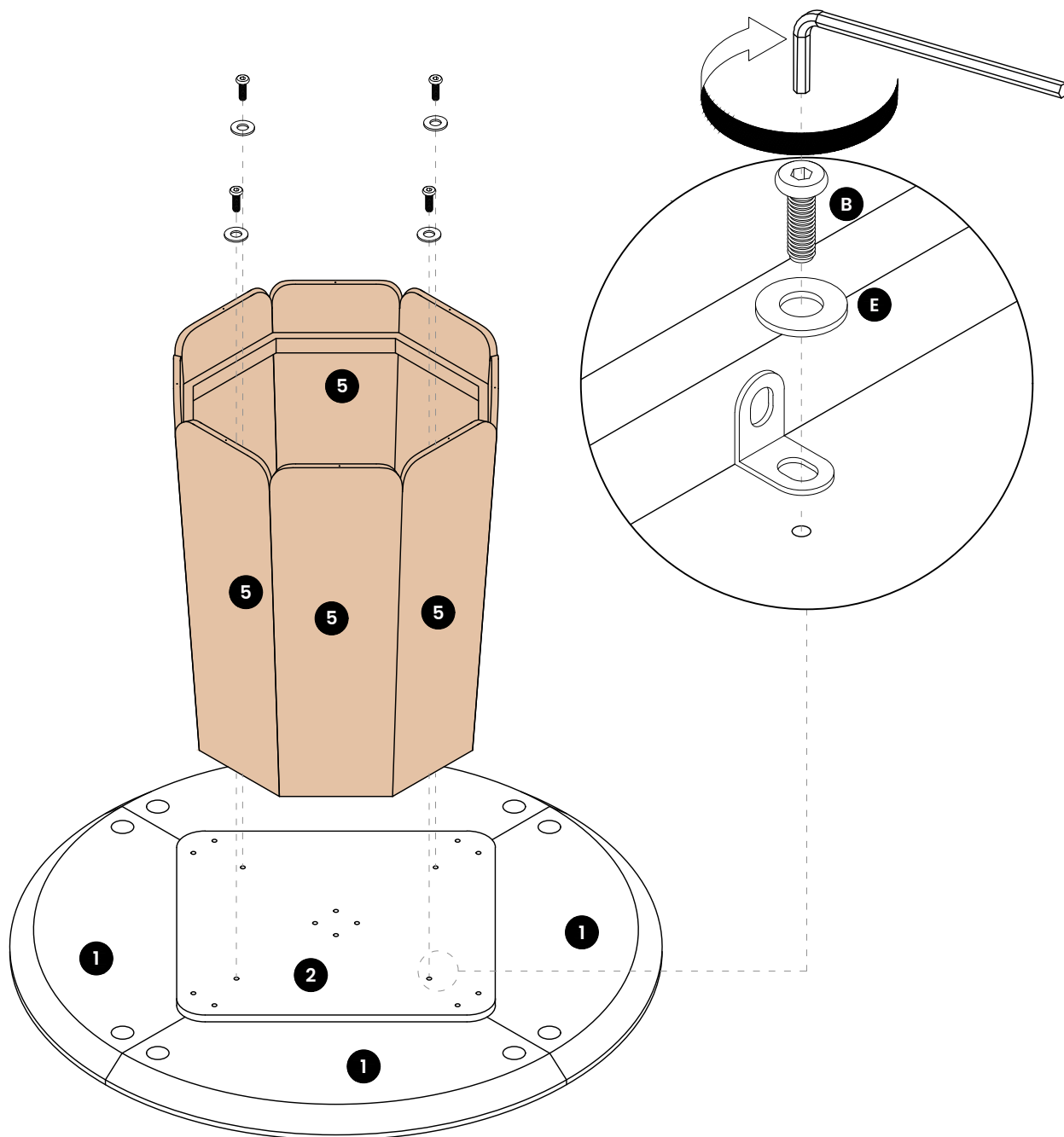

STEP 7

 **J** X8

 **I** X8

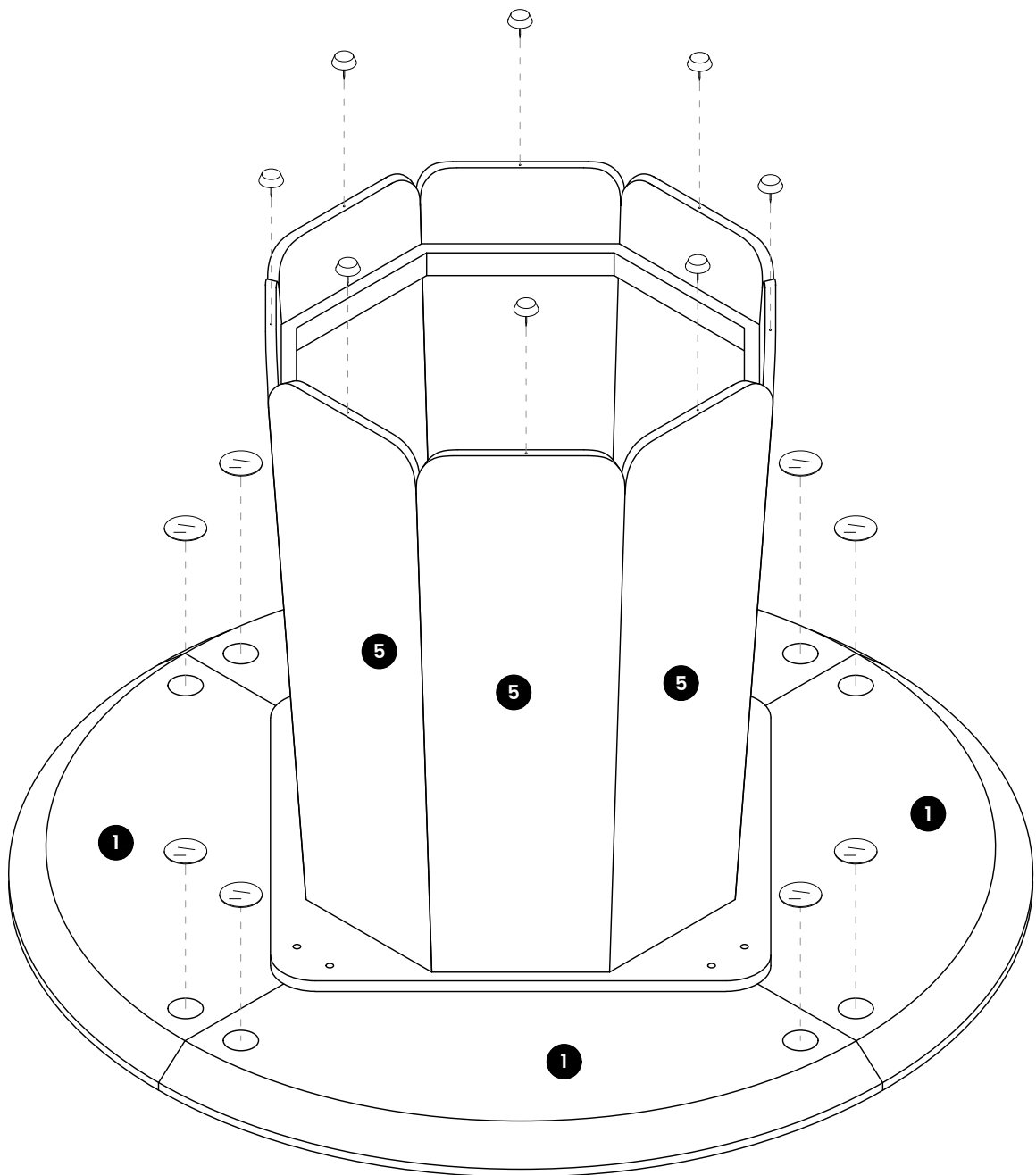



After-Sales Service Hotline: (800) 661-5928