

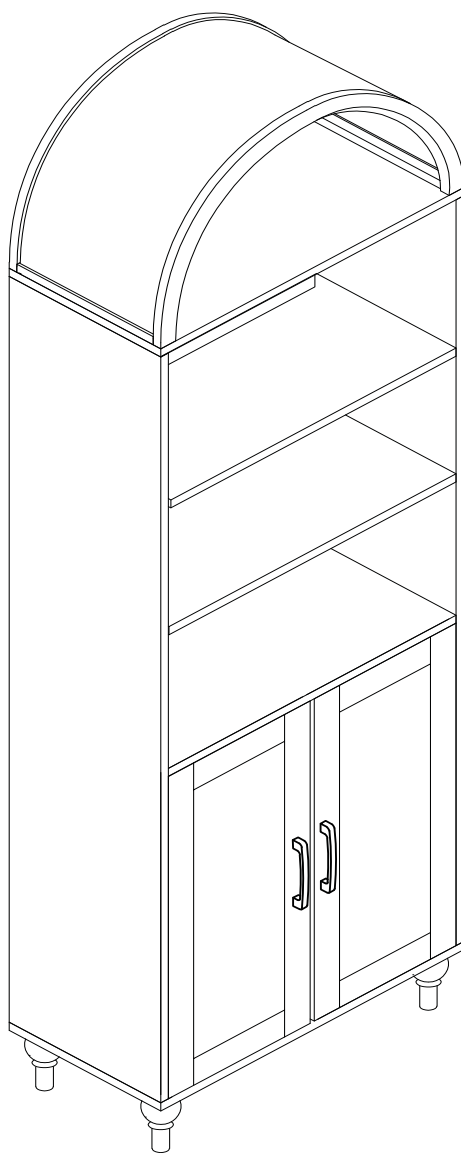

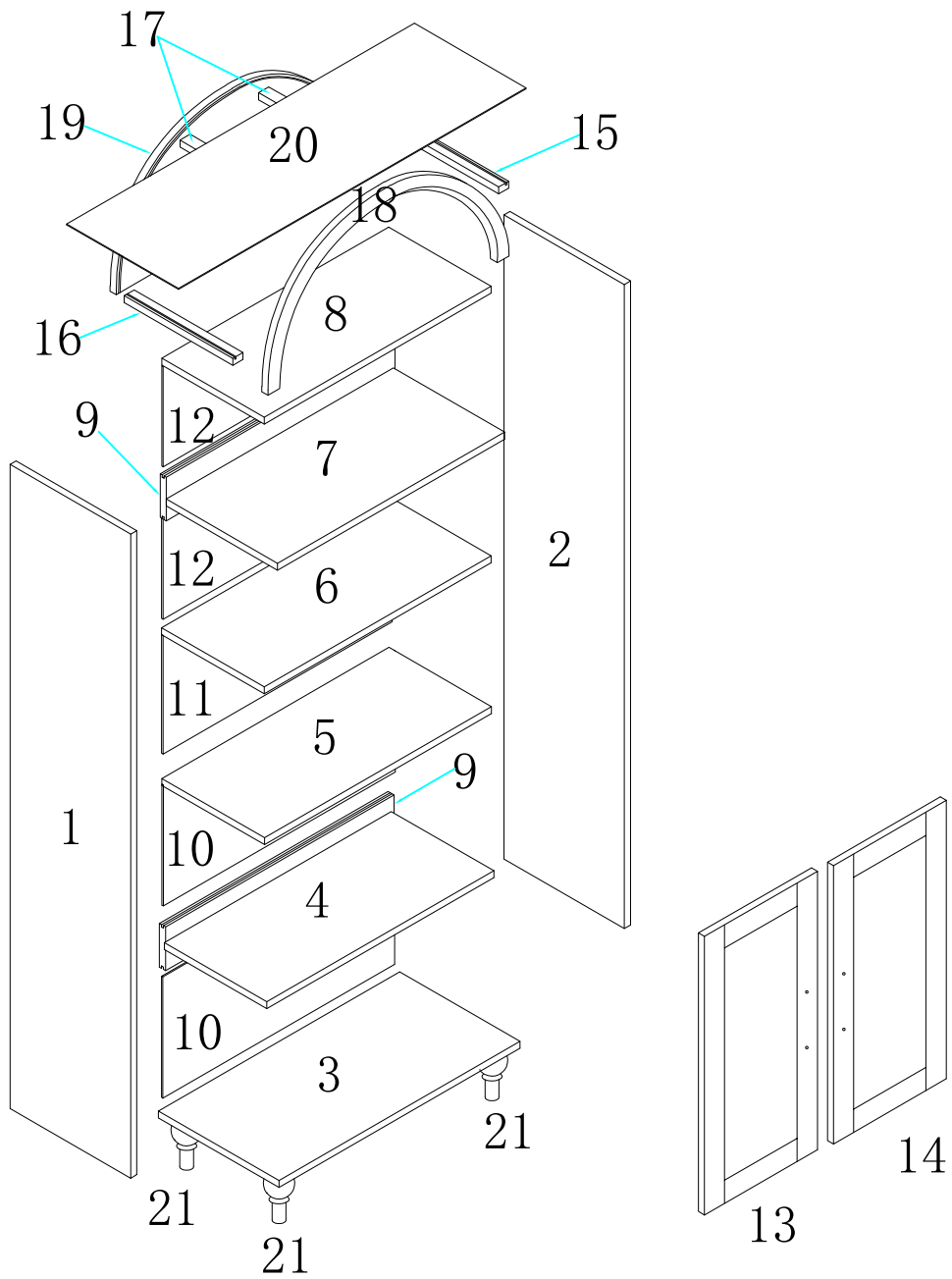









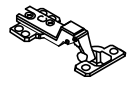

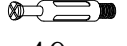









# Assembly Instructions

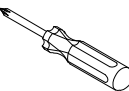
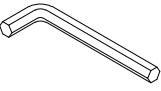



A  3.5*16mm x24+(2)	B  x20	C  14mm x20+(1)	D  x4	E  x4	F  x2	G  40mm x20+(1)	H  ø15 x20+(1)
I  28mm x4+(1)	J  ø12 x4+(1)	K  40mm x4+(1)	L  30mm x4+(1)	M  25mm x6	N  x8	O  x1	P  x2
Q  12mm x4	R  x4	S 	T 	U 	KK  x2	LL  14mm x2	MM  28mm x2
NN  x4	OO  x2						

1

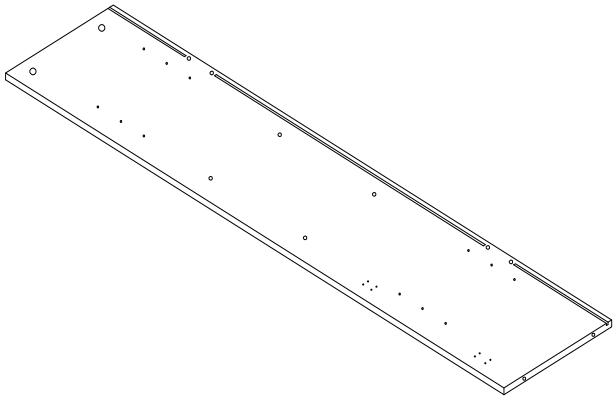

x1

2

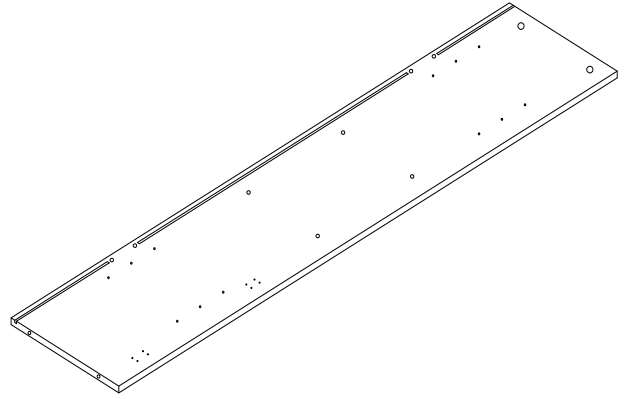

x1

3

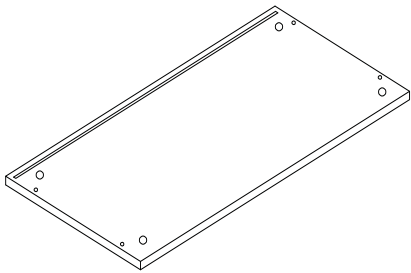

x1

4

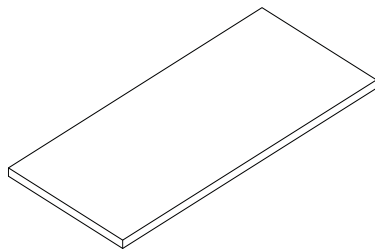

x1

5

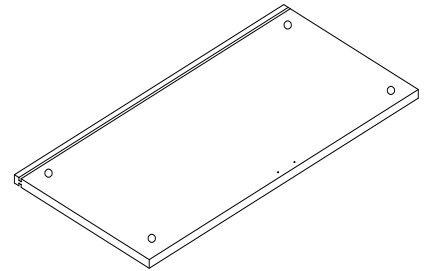

x1

6

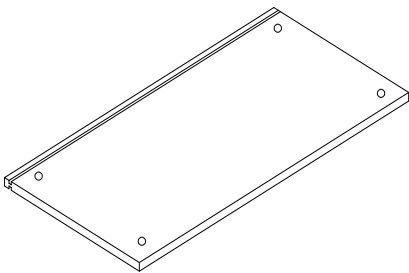

x1

7

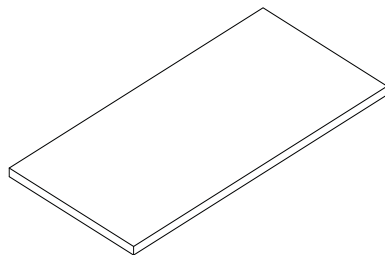

x1

8

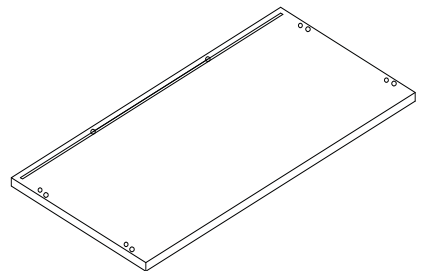

x1

9

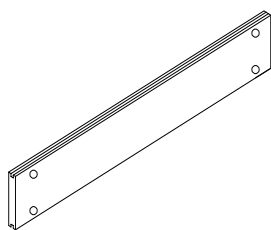

x2

10

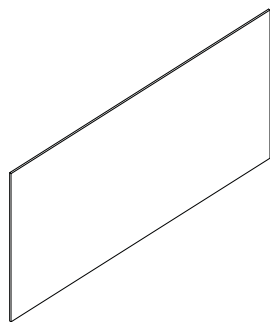

x2

11

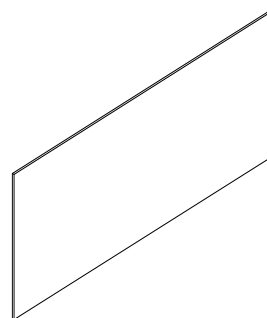

x1

12

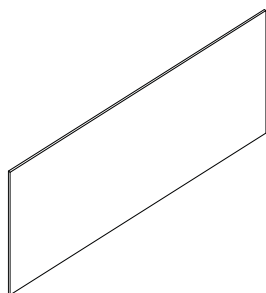

x2

13

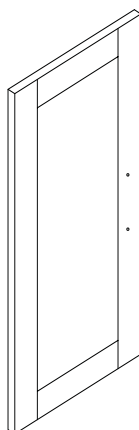

x1

14

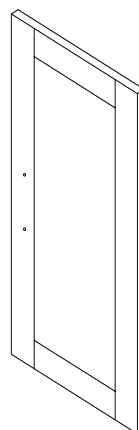

x1

15

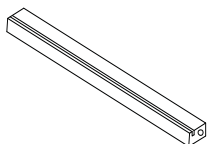

x1

16

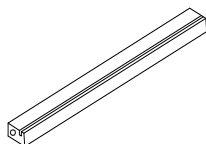

x1

17

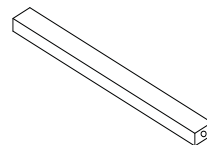

x2

18

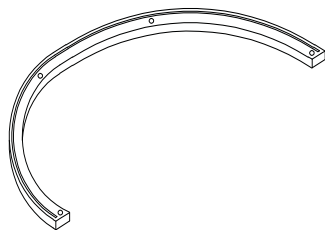

x1

19

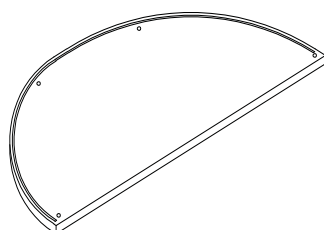

x1

20

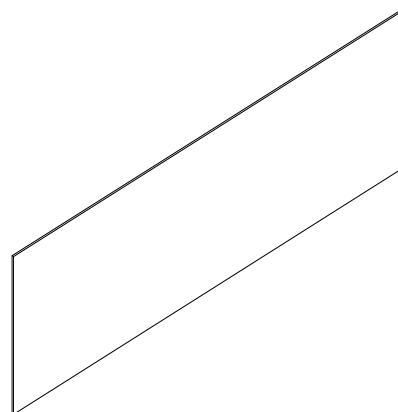

x1

21

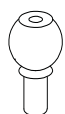

x4



## Hardware installation demonstration

- Please make sure G.I hardware tightened and can't be pulled out

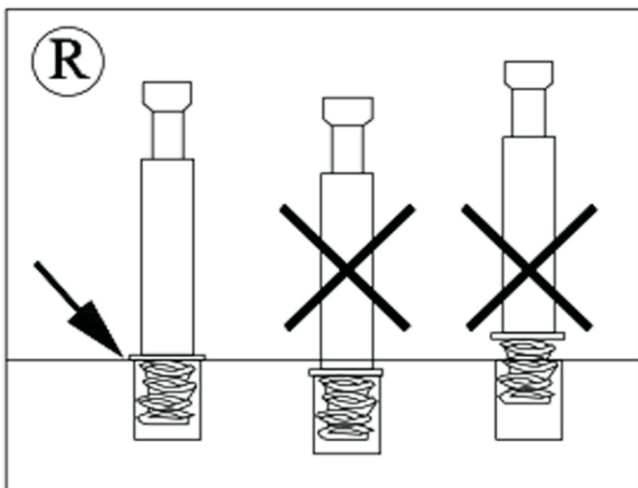
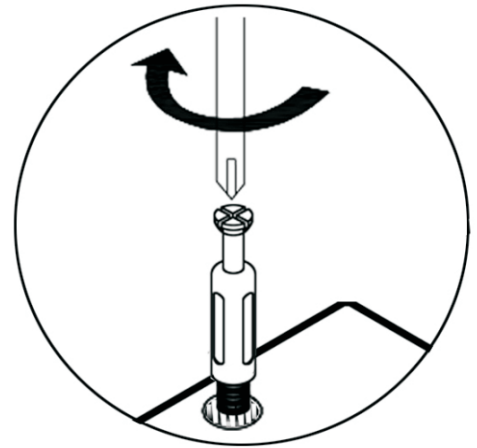
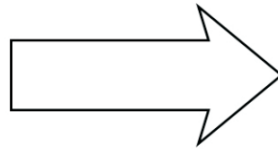
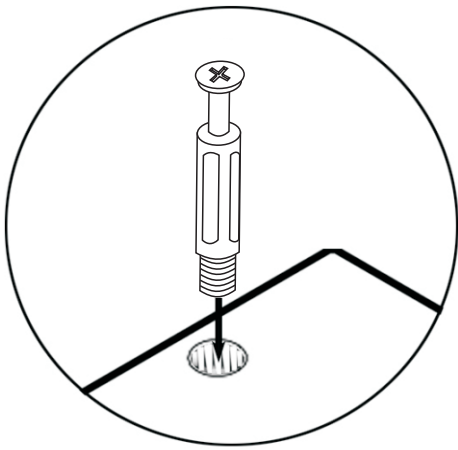



## Hardware installation demonstration

- When inserting cam ensure arrowhead on cam points toward to the hole on the panel edge

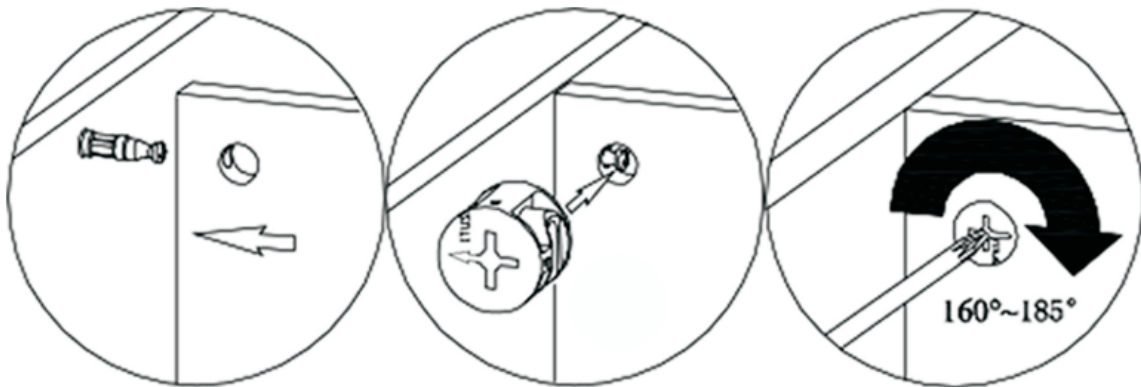

How TO ADJUST THE EUROPEAN ADJUSTABLE HINGES ON DOOR  
If the doors require adjustment, follow the below options as needed: To adjust door up or down, loosen screws (a), adjust door and retighten screws. To adjust door left and right, turn screw (b) in or out. To adjust door in and out, loosen screw (c), adjust door and retighten screw.

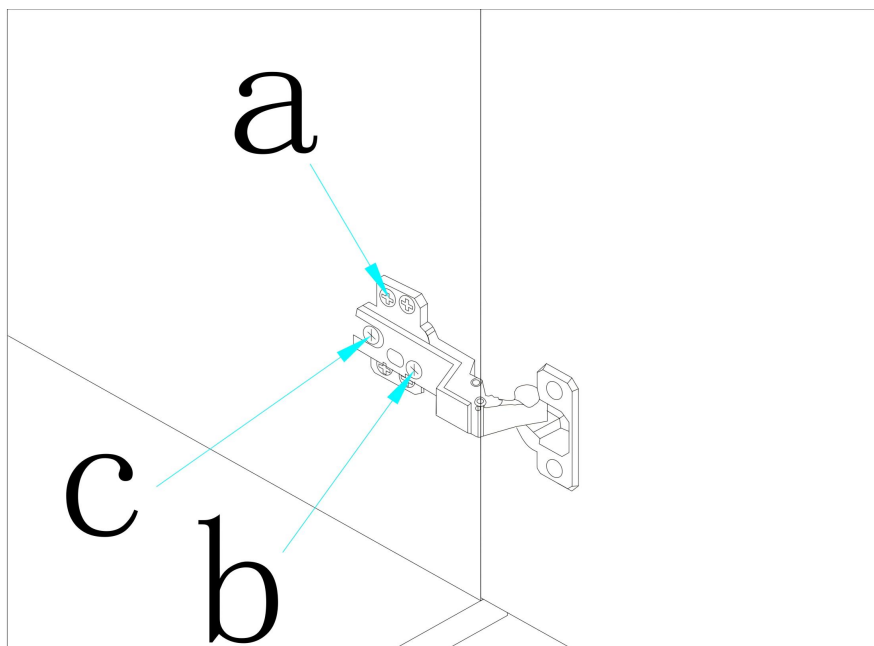

# Step01

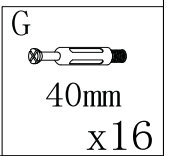
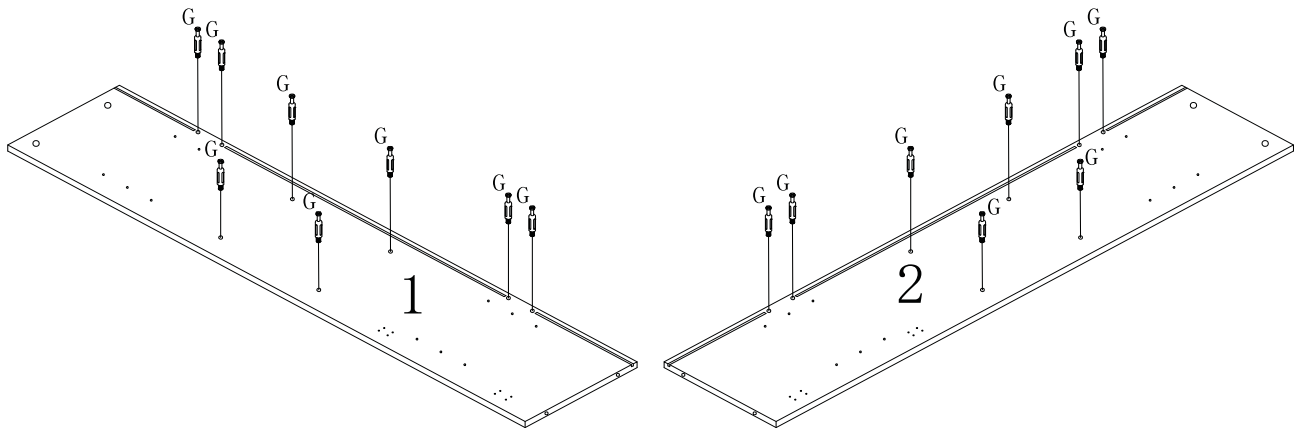

# Step02

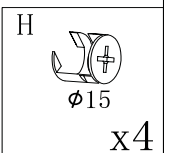
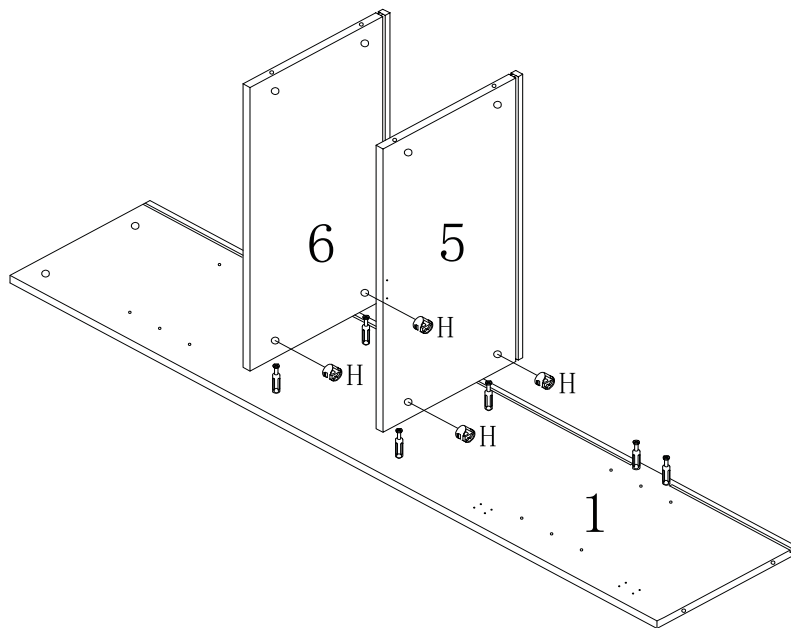

# Step03

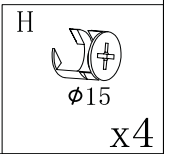
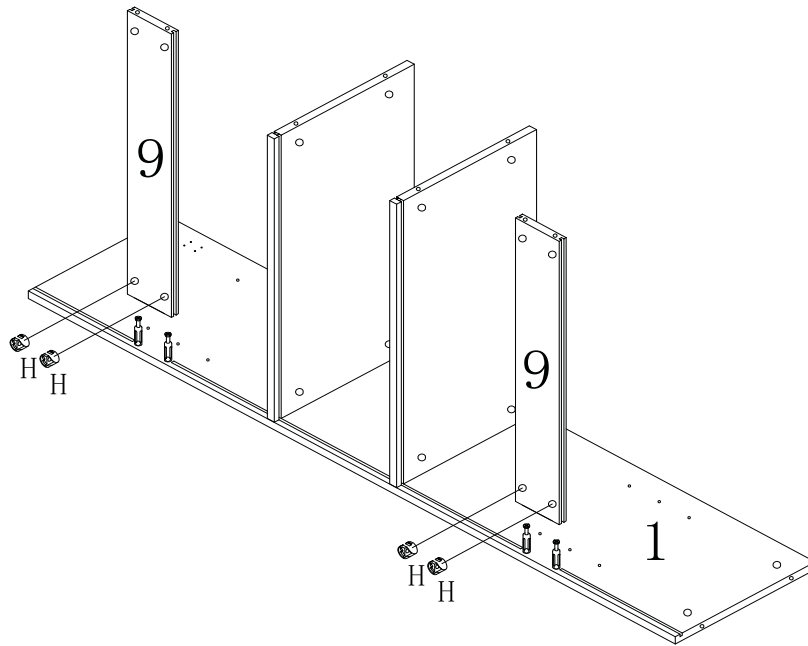

# Step04

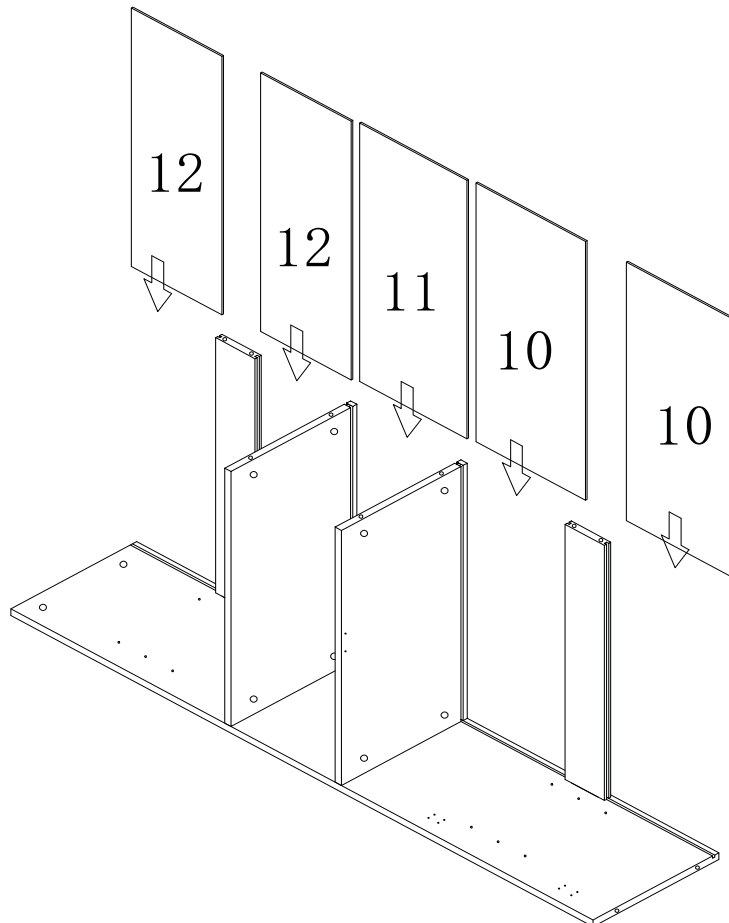

# Step05

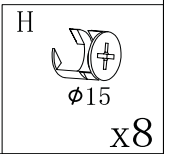
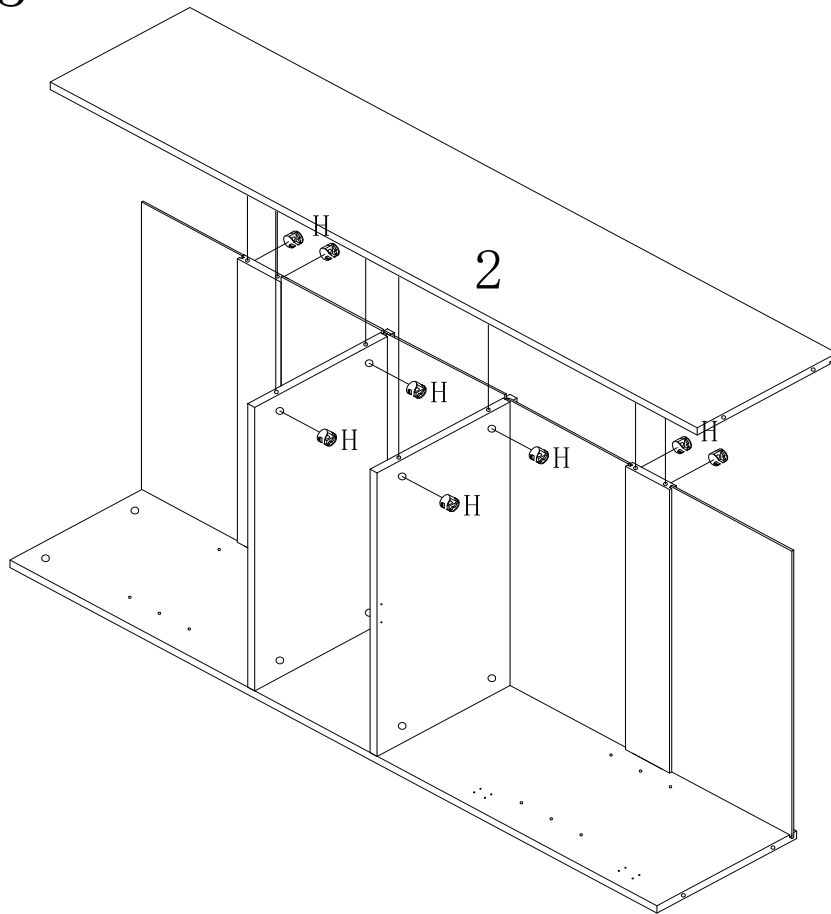

# Step06

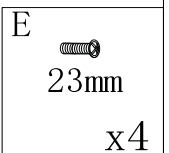
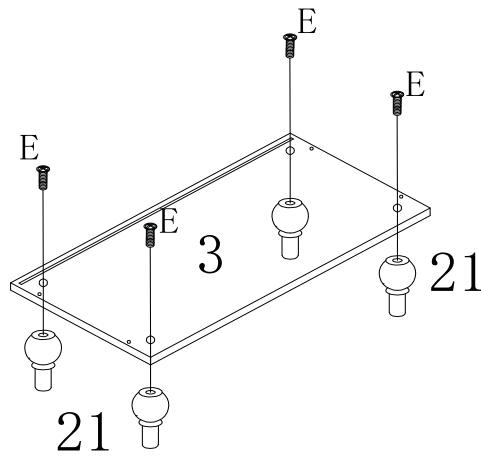

# Step07

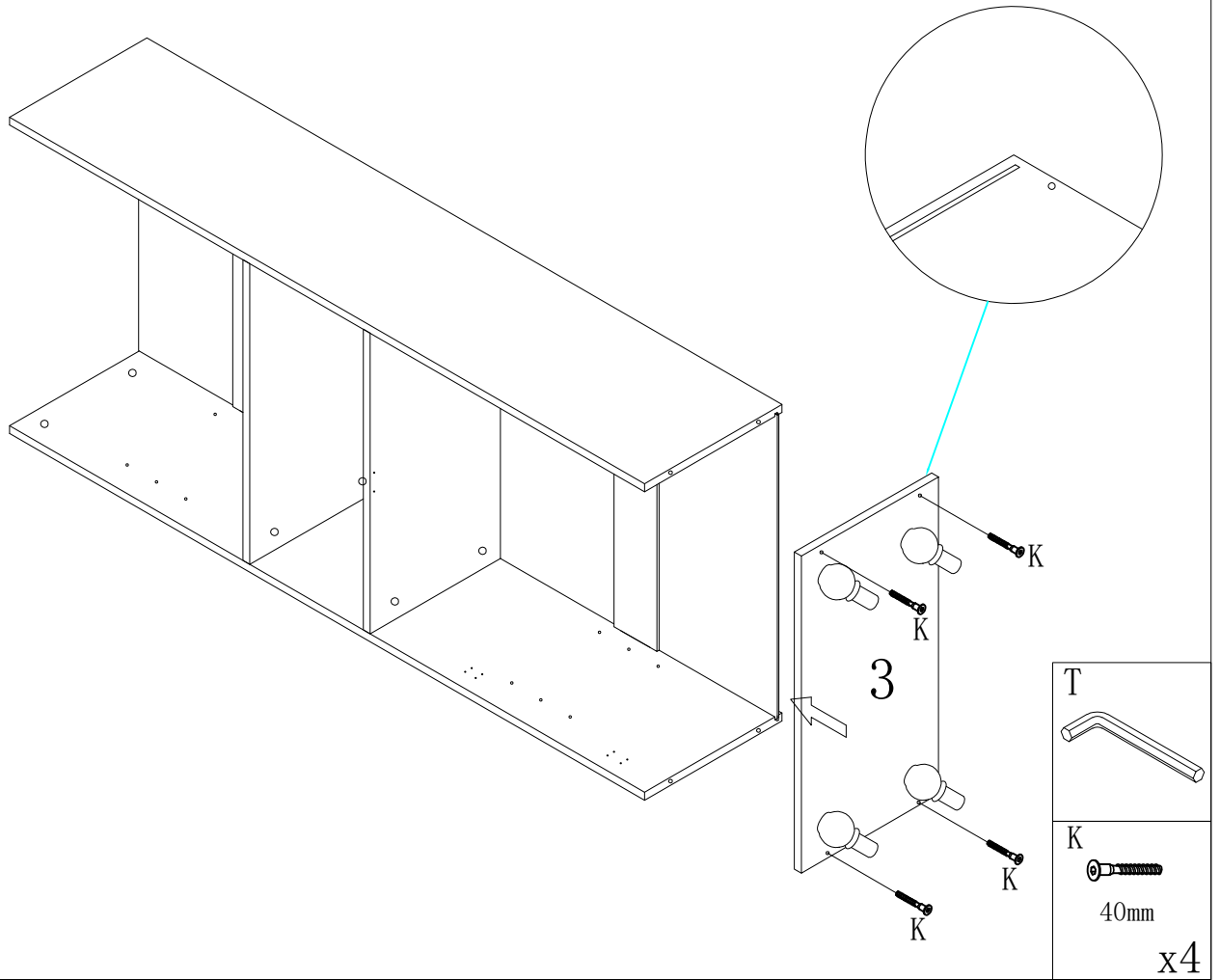

# Step08

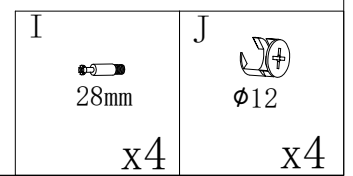
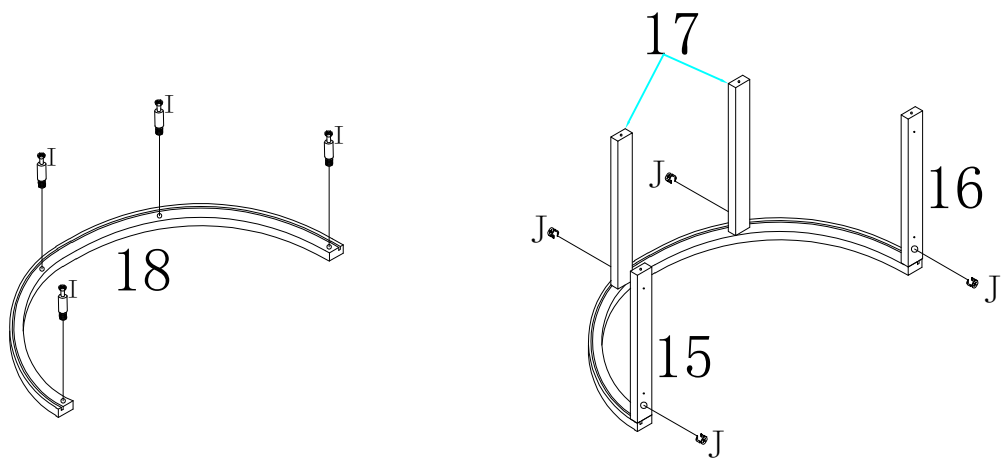

# Step09

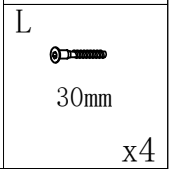
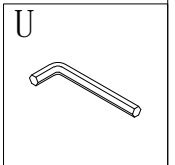
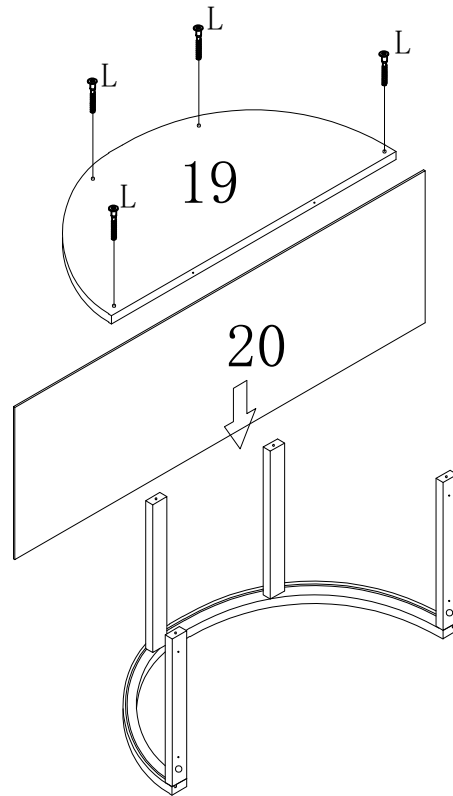

# Step10

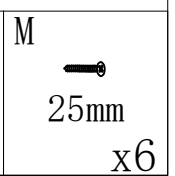
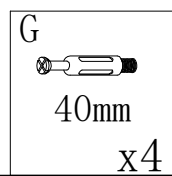
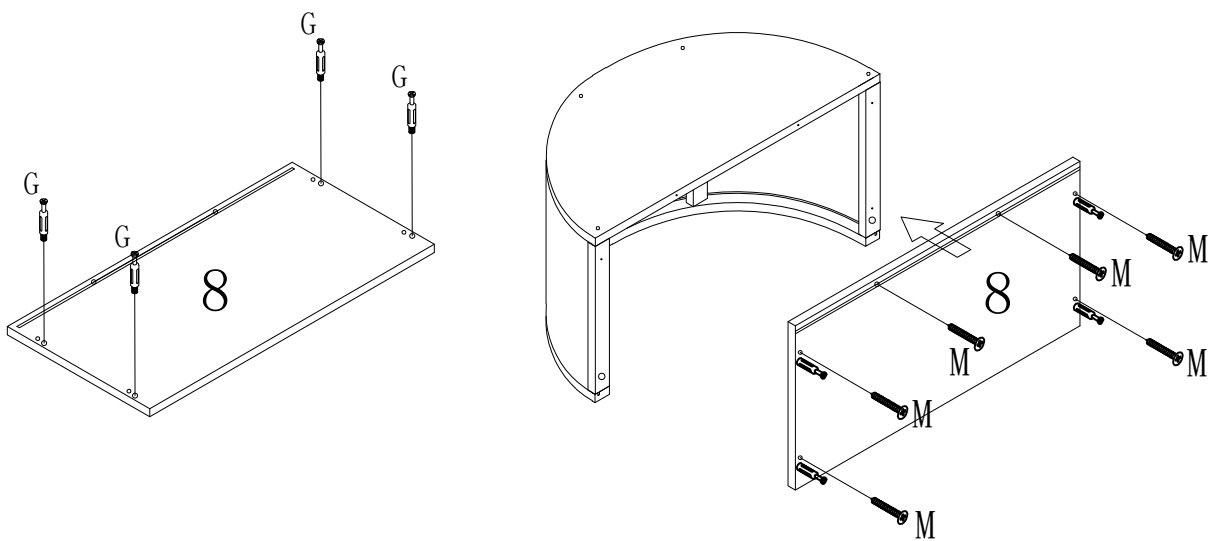

# Step11

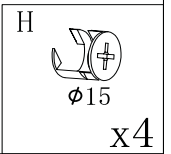
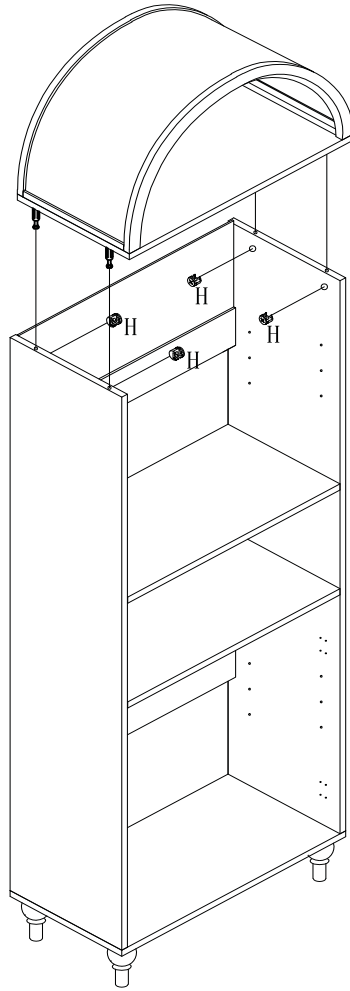



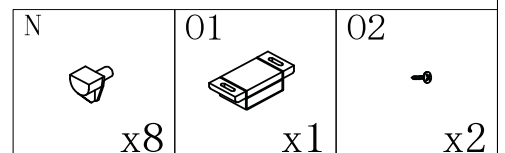
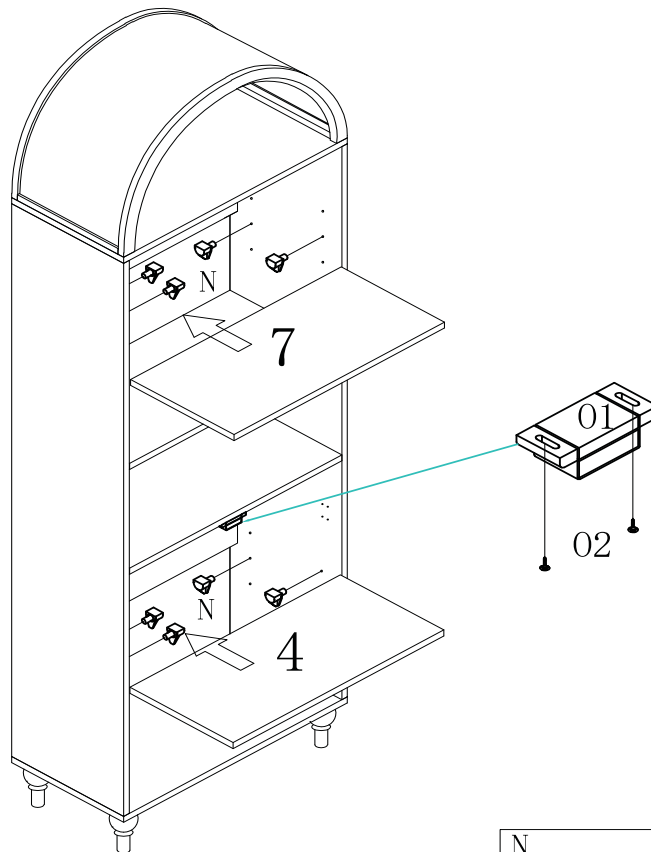

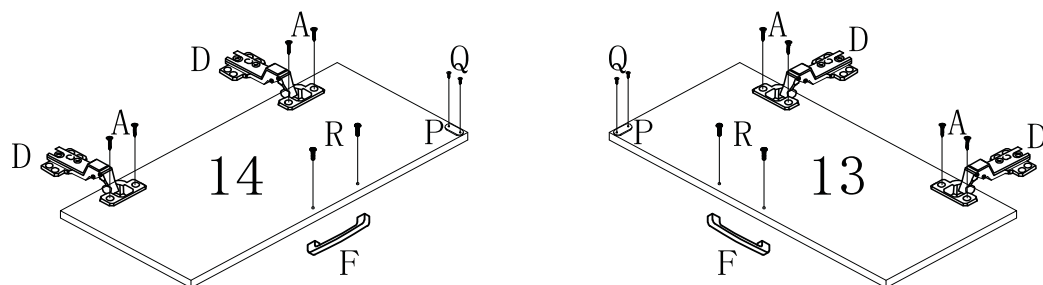

# Step12



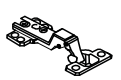

# Step13



<p>A</p>  <p>3.5*16mm x8</p>	<p>Q</p>  <p>12mm x4</p>	<p>D</p>  <p>x4</p>	<p>F</p>  <p>x2</p>	<p>P</p>  <p>x2</p>	<p>R</p>  <p>x4</p>
---	---	---	--	--	--

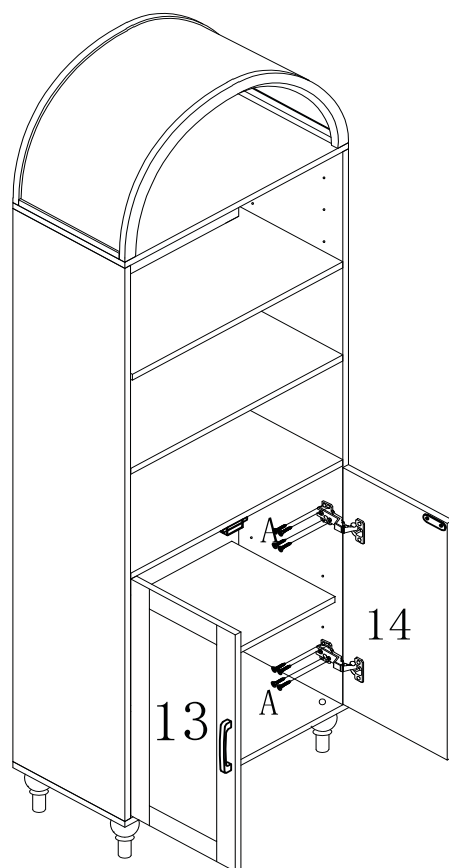

# Step14



<p>A</p>  <p>3.5*16mm x16</p>
--

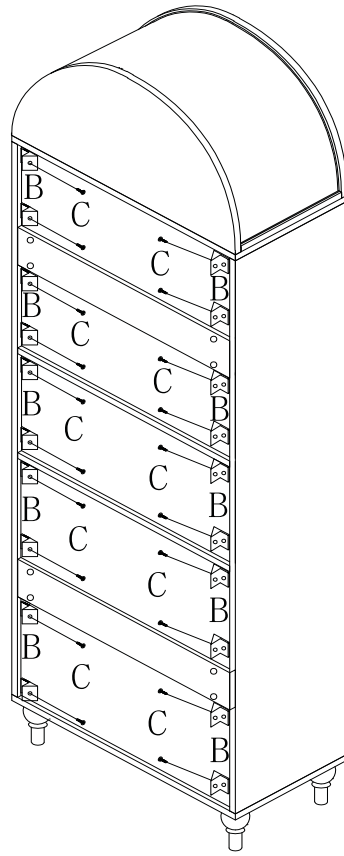

# Step15

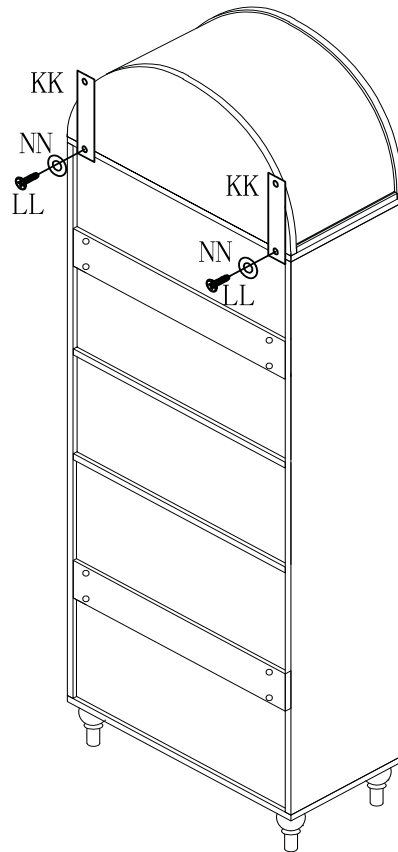

B	C
	
x20	14mm x20

# Step16





KK	LL	NN
	 14mm	

# Step17

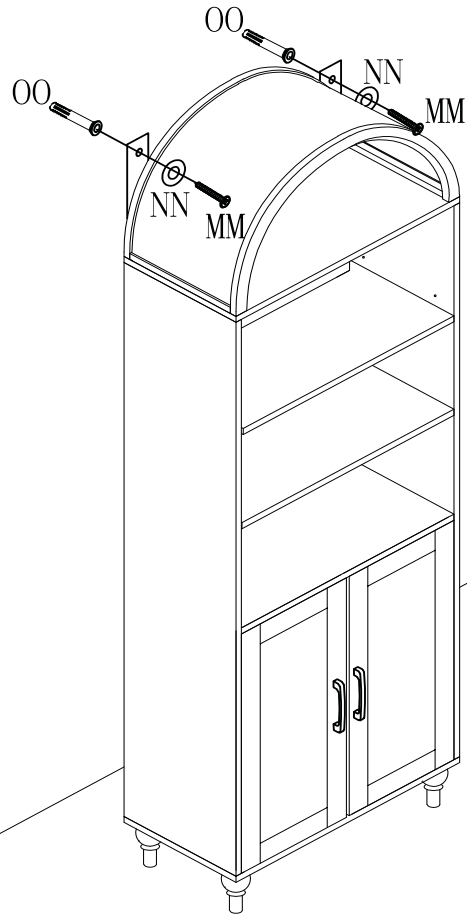
WALL



MM  28mm x2	NN  x2	OO  x2
---	---	---