

# INSTALLATION GUIDE

## WARNINGS AND CAUTIONS

Released Date:2025-04

### READ AND SAVE THESE INSTRUCTIONS

Please read and understand this entire manual before attempting to assemble, install or operate the product.

#### WARNING

- RISK OF ELECTRIC SHOCK - Before beginning installation, turn off electricity at the circuit breaker box or the main fuse box.
- RISK OF FIRE - Use bulbs specified by the markings and/or labels on the fixture.

#### CAUTION

- For your safety, read instructions completely before beginning installation.
- If in doubt about electrical installation, consult a licensed electrician.
- Turn off electricity to fixture before replacing the bulb(s).

#### TOOLS REQUIRED

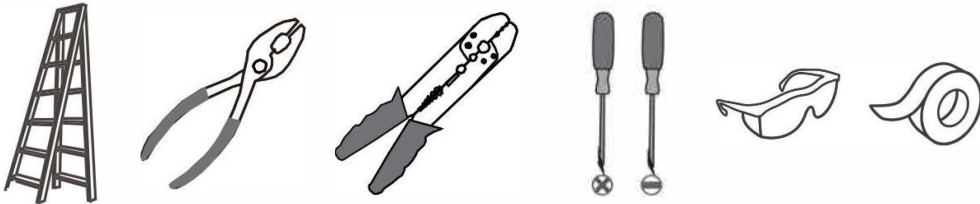

#### CARE AND MAINTENANCE

- Wipe clean using soft, dry cloth or static duster. Always avoid using harsh chemicals and abrasives to clean fixture as they may damage the finish.

# PACKAGE CONTENTS

**A** Ceiling Canopy  
x 1

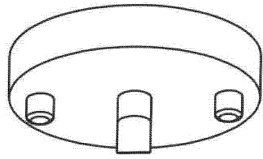

**C** Forest Deer Iron Panel  
x 4

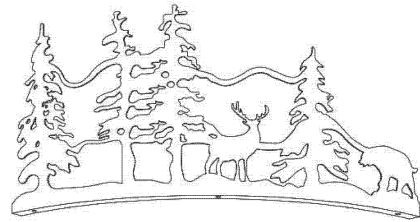

**B** Fixture Chain  
x 1

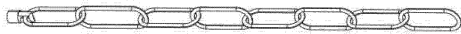

**D** Connecting Rod  
x 8



**E** Fixture Body Frame  
x 1

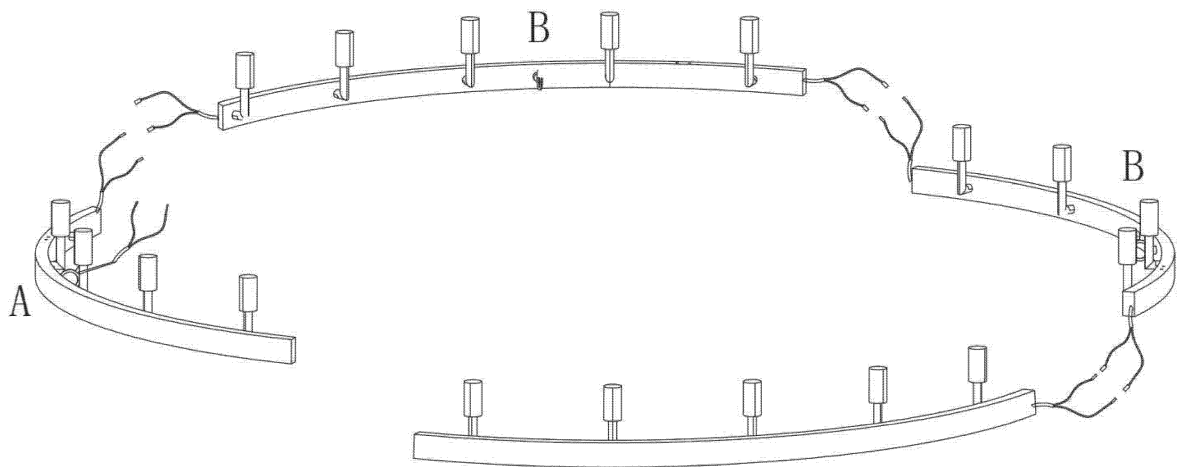

**F** Frame Connector  
x 4

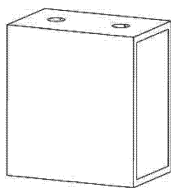

**H** Carabiner  
x 12

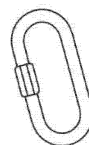

## PACKAGE CONTENTS (PARTS BAG 1)

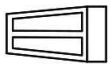

**AA** Wire Connector  
x 4

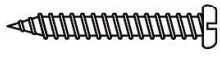

**BB** Screw  
x 4



**CC** Wall Anchor  
x 4



**EE** Mechanical Screw  
x 2

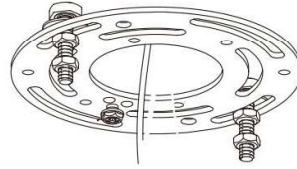

**FF** Mounting Bracket  
x 1

## PACKAGE CONTENTS (PARTS BAG 2)

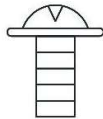

**KK** Spare Screws  
x 4

- 1** Unscrew the 7 screws from each Fixture Body Frame (A, B, B, and C), totaling 28 screws. Please keep them safely, as they will be required for later steps

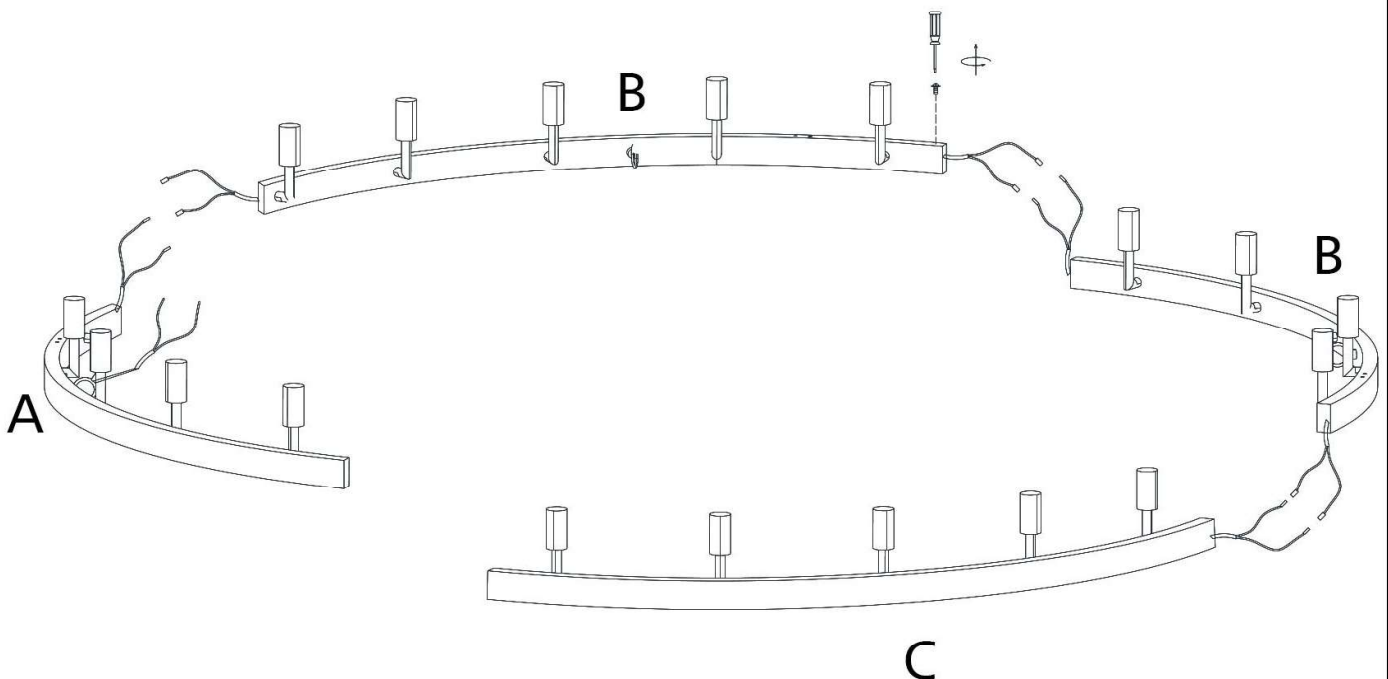

## INSTALLATION

- 2** Insert each of the 4 frame connectors into the corresponding connection points A, B, C, and D on the Fixture Body Frame

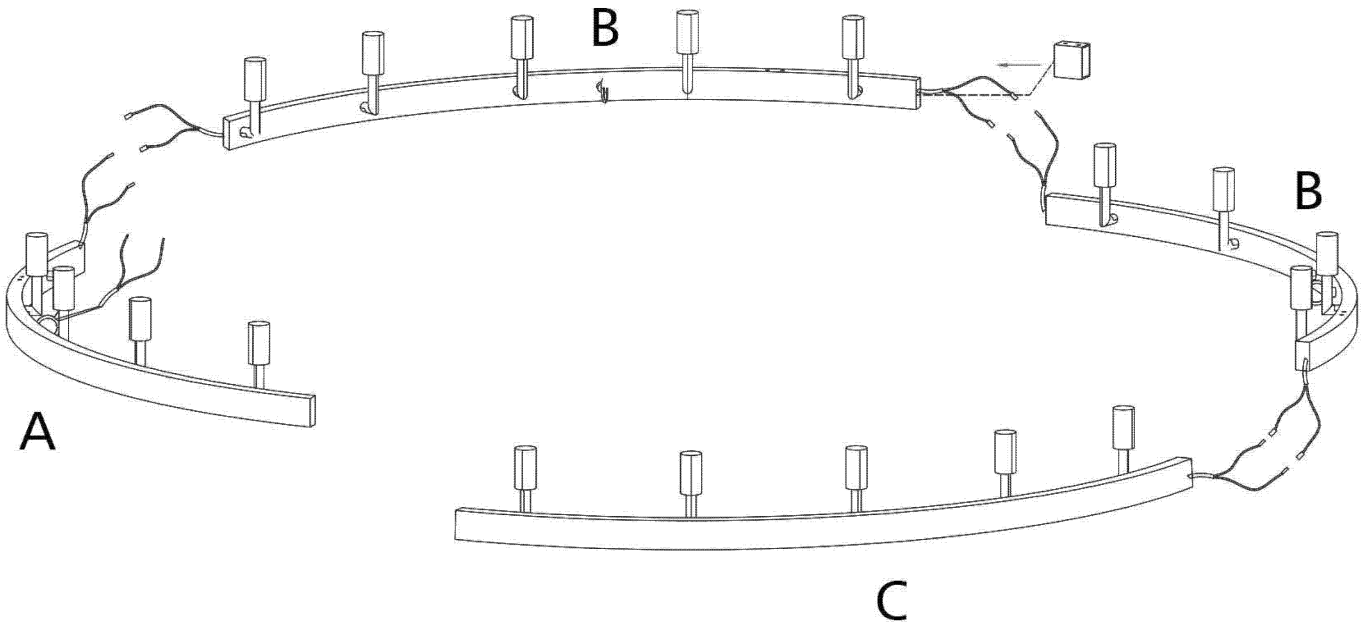

- 3** Place the Fixture Body Frames in the sequence A-B-B-C according to the diagram. Then, connect the internal plugs of the Frame Connectors, ensuring black is connected to black and white to white

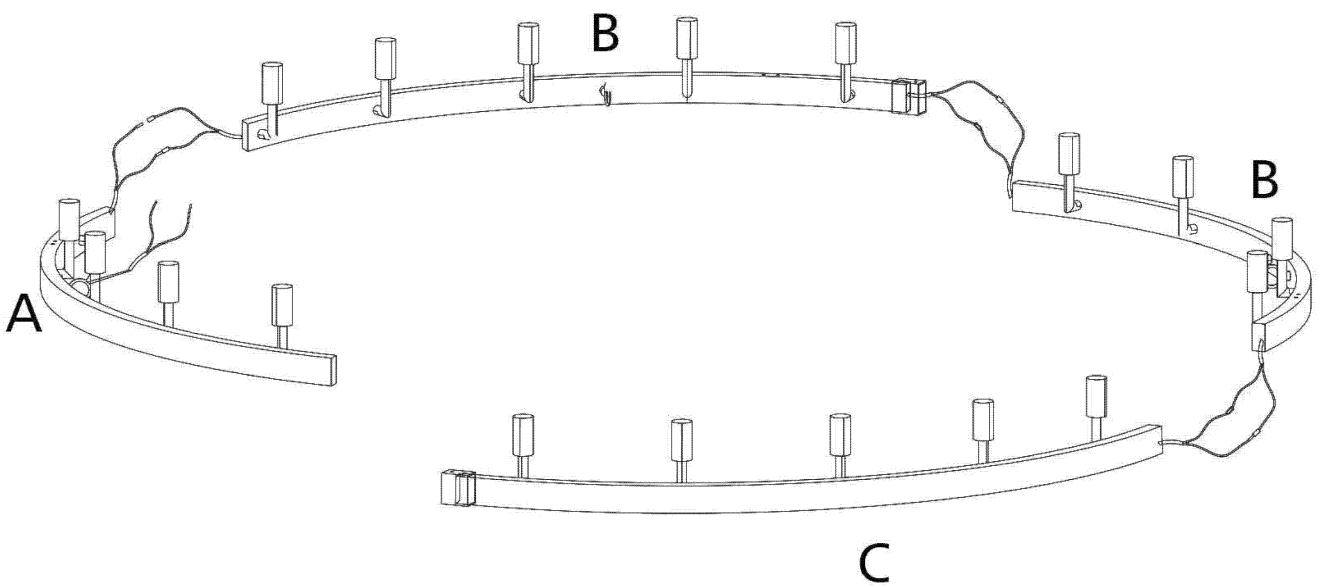

## INSTALLATION

- 4 Align the screw holes of the frame connector with those on the fixture body frame and secure them with 2 screws, a total of 8 screws are required

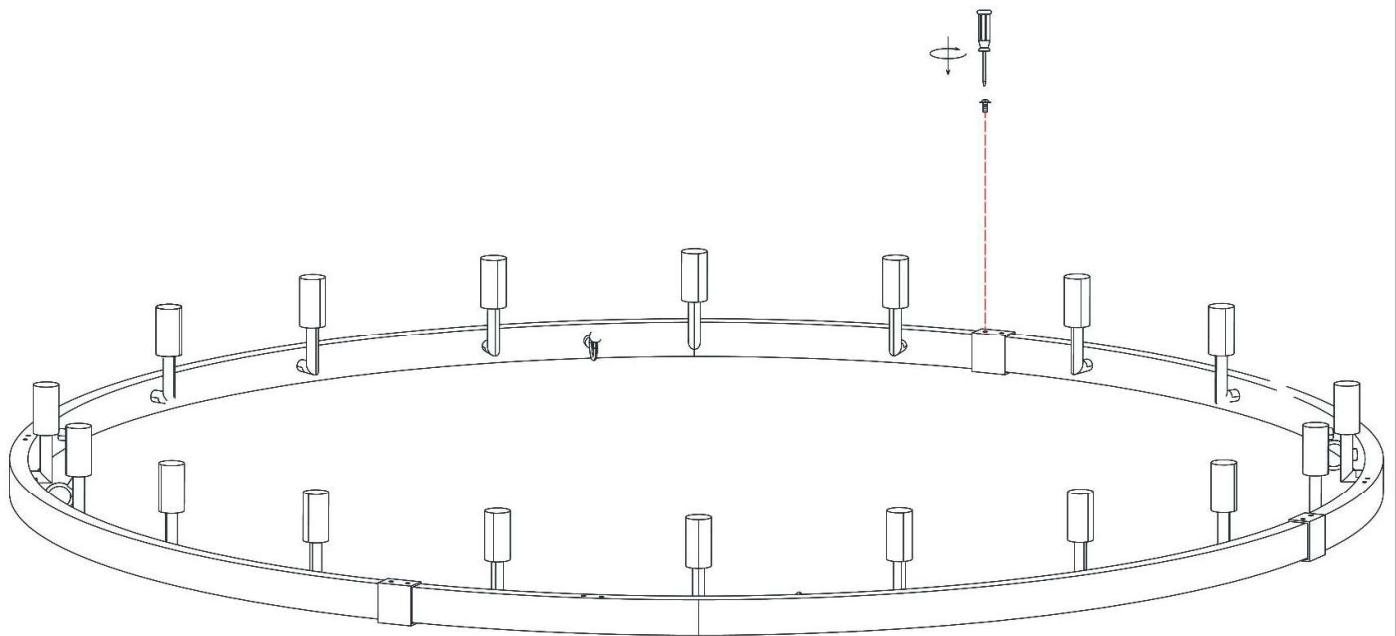

## INSTALLATION

**5**

1. Use 4 carabiners to pair and connect the 8 connecting rods (2 rods per carabiner)

2. Use a carabiner to connect the ring on the fixture body frame to the ring on the connecting rod

3. Use a carabiner to connect the ring on the lamp holder to the ring on the connecting rod

4. Use the carabiner on the hanging chain to connect to the ring on the lamp holder

5. Use the carabiner on the hanging chain to connect to the ring on the ceiling canopy

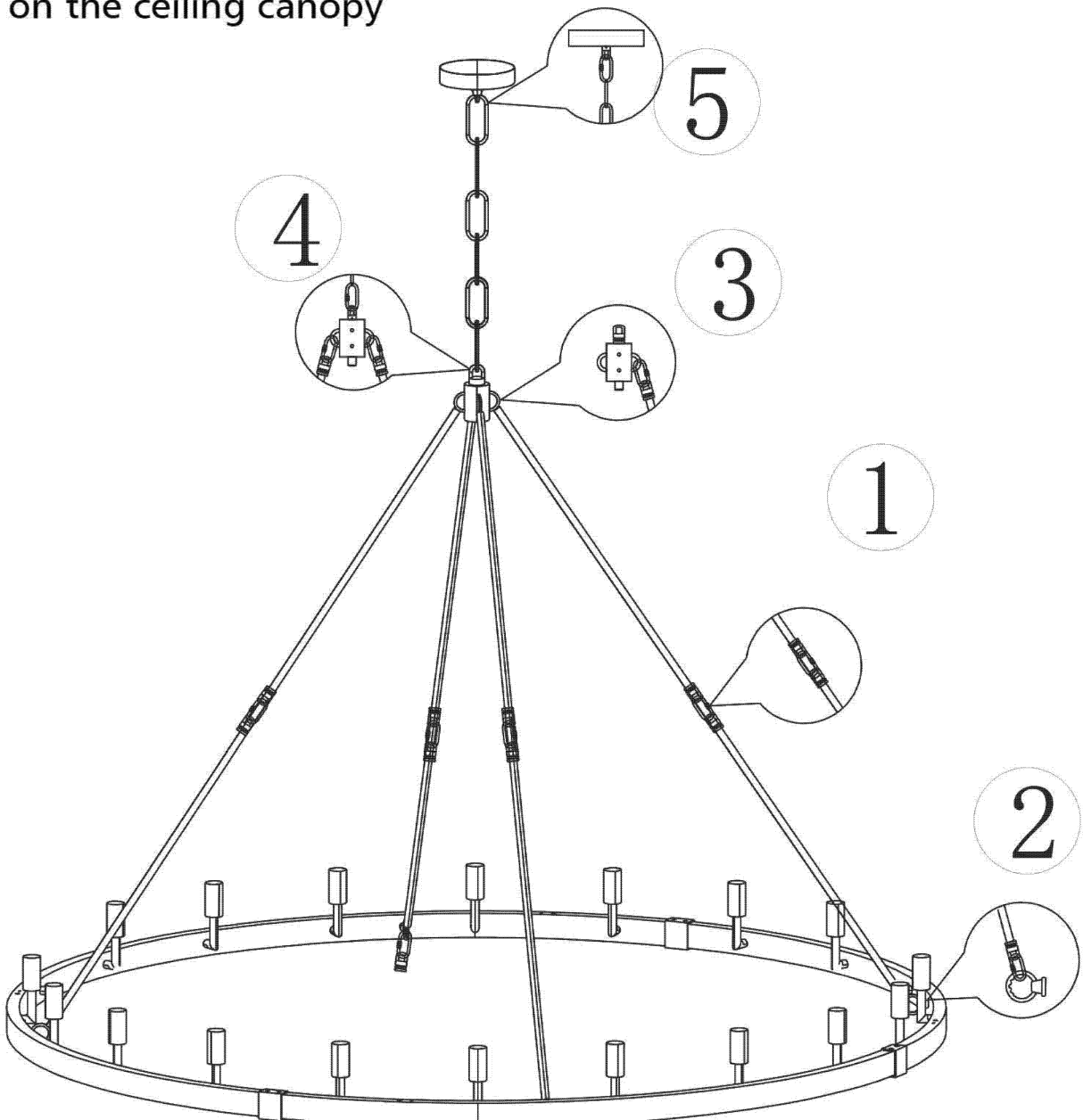

## INSTALLATION

- 6** 1. Unscrew the nuts **1** on both sides of the ceiling canopy.  
2. Take out the hanging bracket. **2**

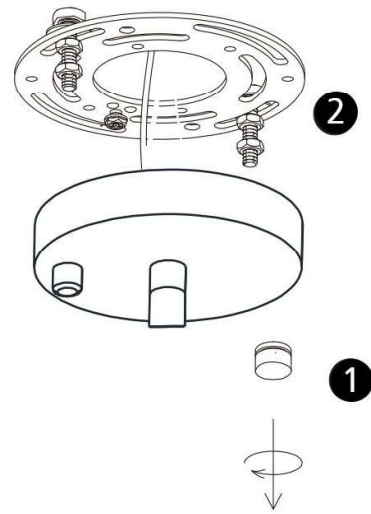

- 7** Install the Mounting Bracket

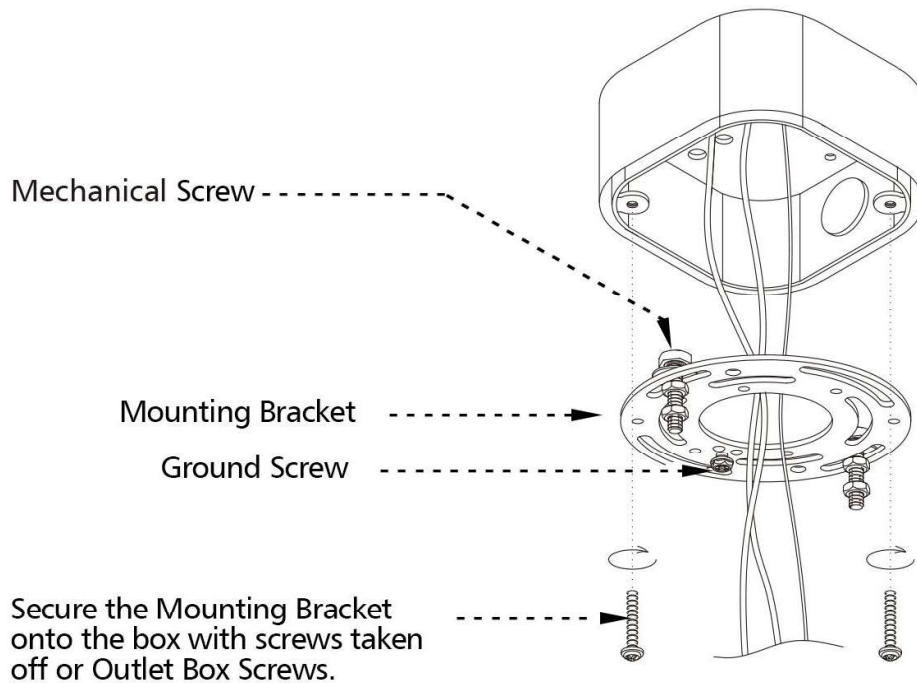

## INSTALLATION

**8** Thread the wire through the chain and the canopy

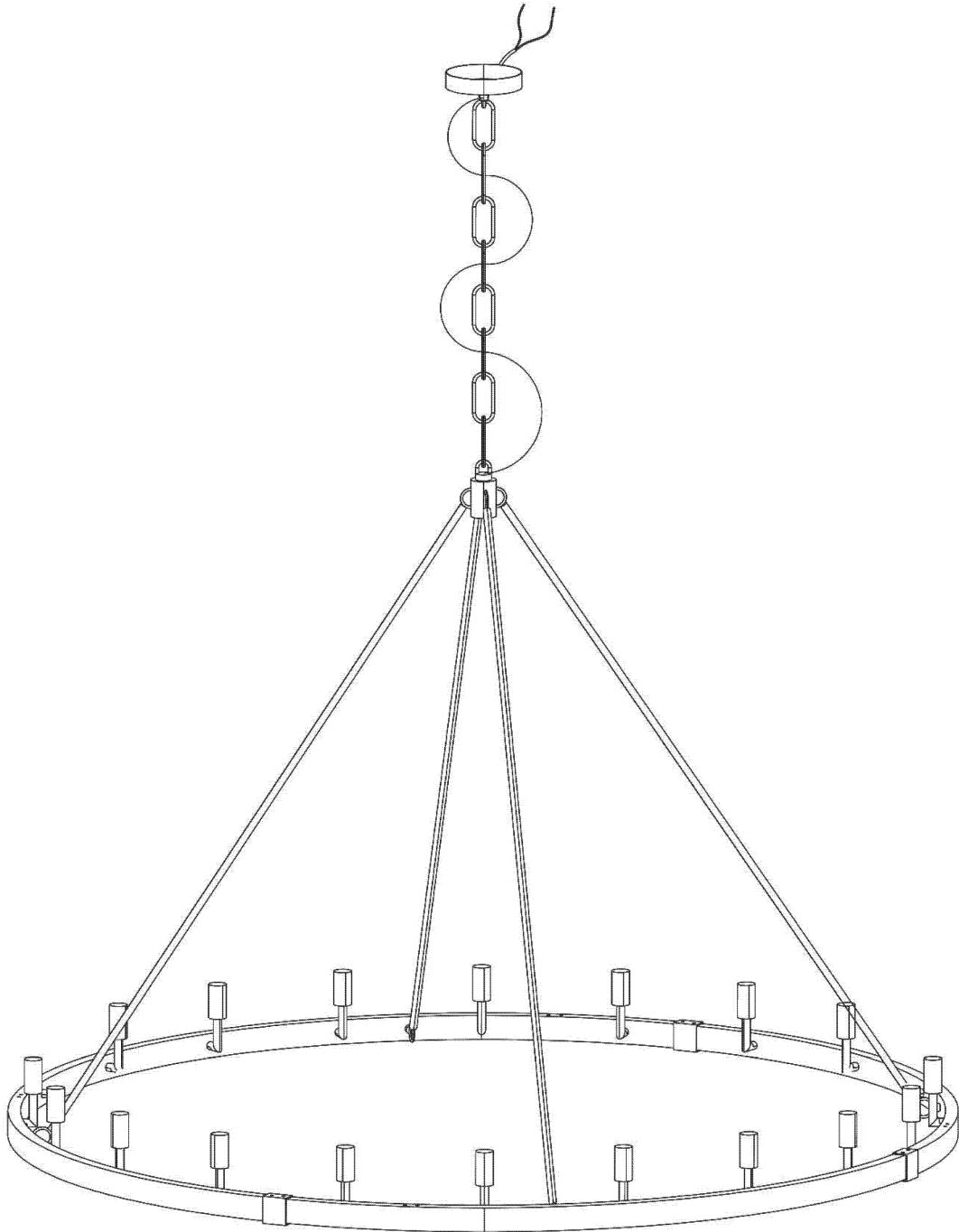



## INSTALLATION

**11** The remaining 20 screws will be used to secure the Forest Deer Iron Panel.

Each Forest Deer Iron Panel requires 5 screws for installation.  
Align the holes and tighten the screws accordingly

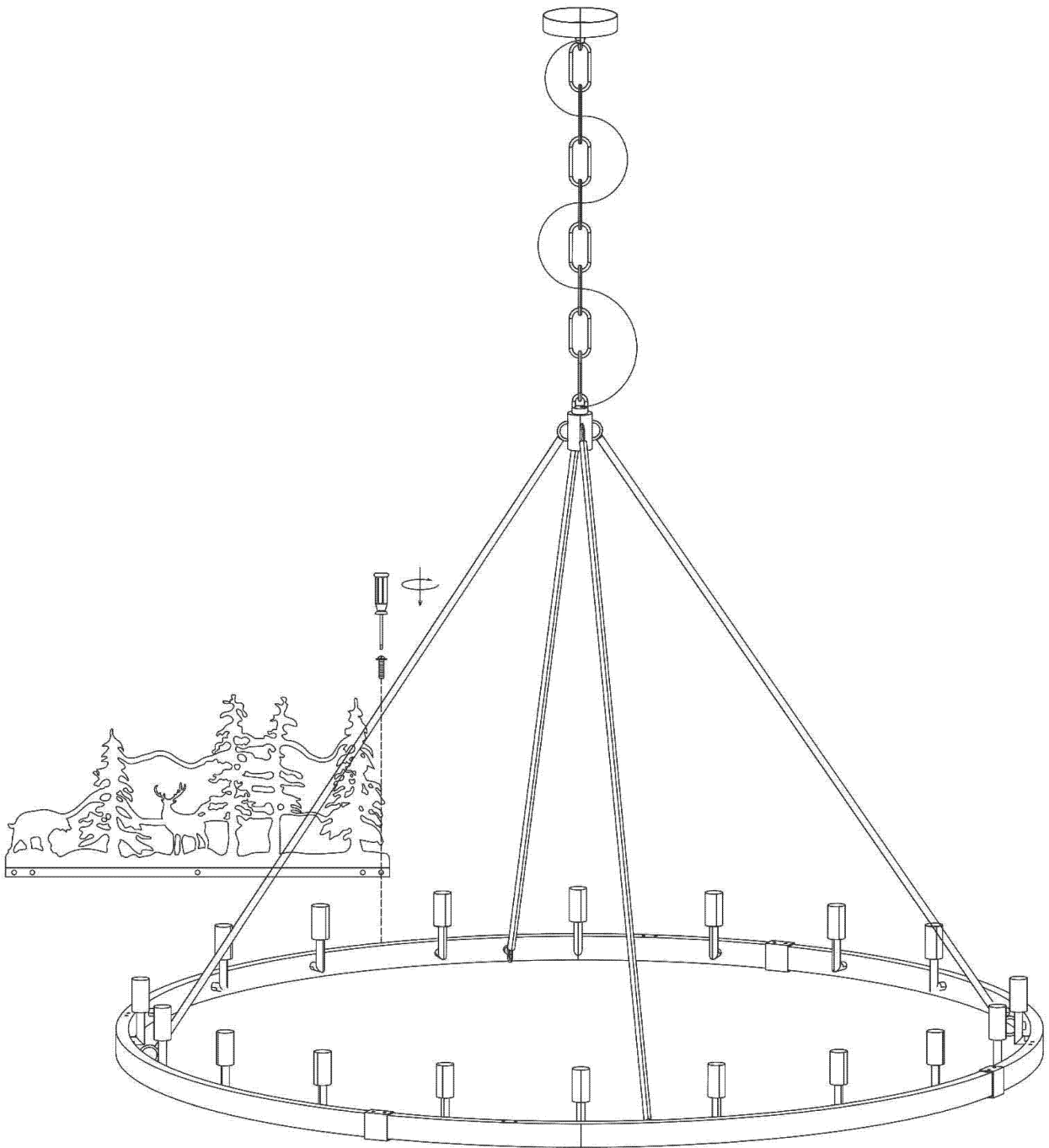

## INSTALLATION

### 12 Install 20 bulbs with E12 base

