





15'

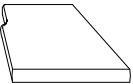
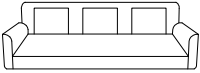
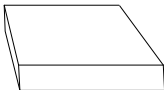

2

<b>A</b>	<b>B</b>	<b>C</b>	<b>D</b>	<b>E</b>	<b>F</b>
					
<b>x 3</b>	<b>x 1</b>	<b>x 1</b>	<b>x 1</b>	<b>x 1</b>	<b>x 8</b>

**A x 3**

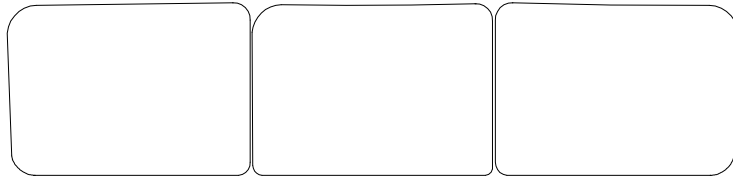

**B**

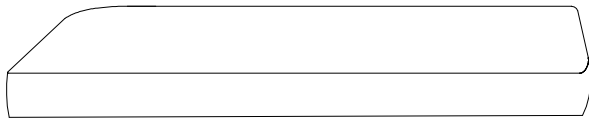

**C**

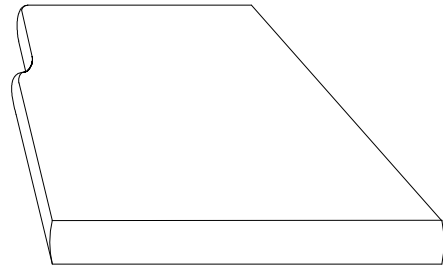

**D**

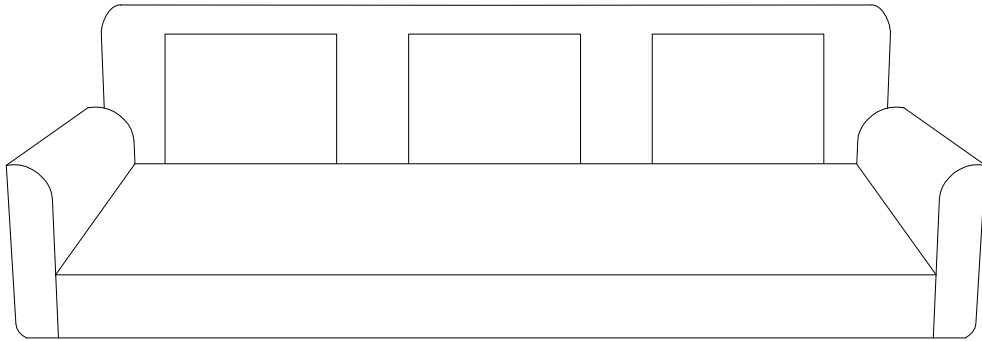

**F x 8**

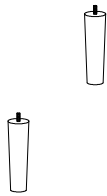

**E**

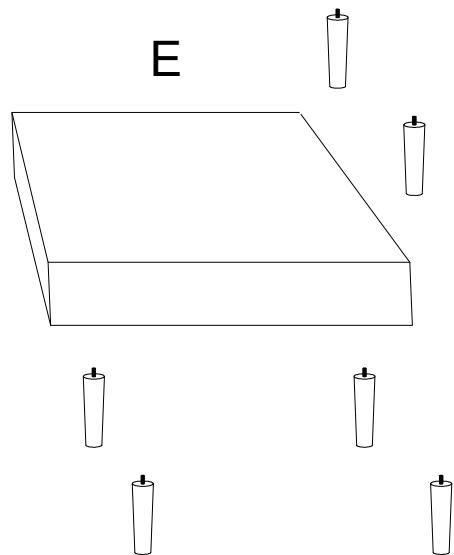

1

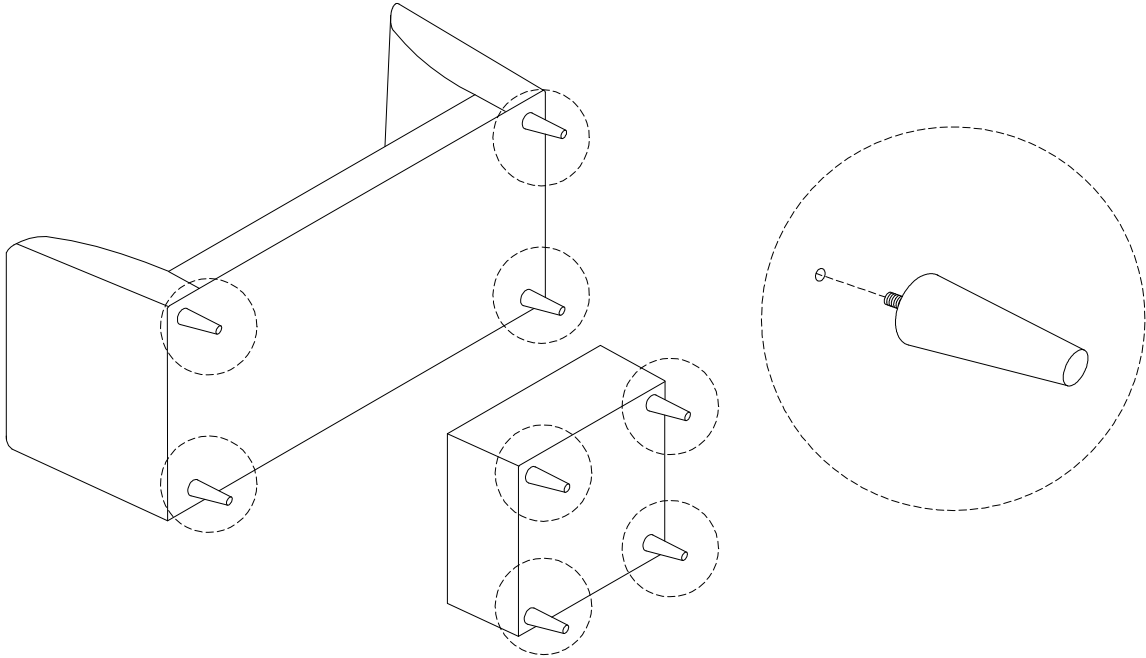
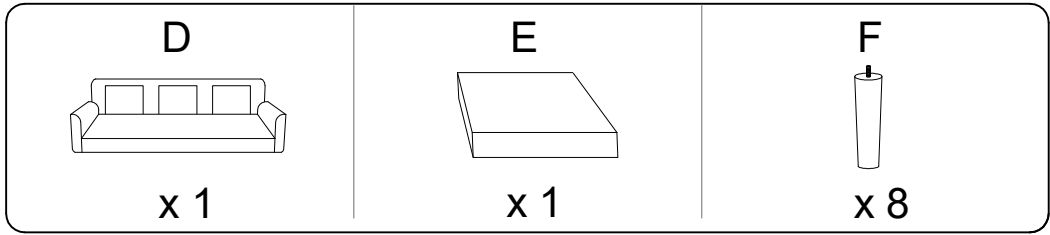

2

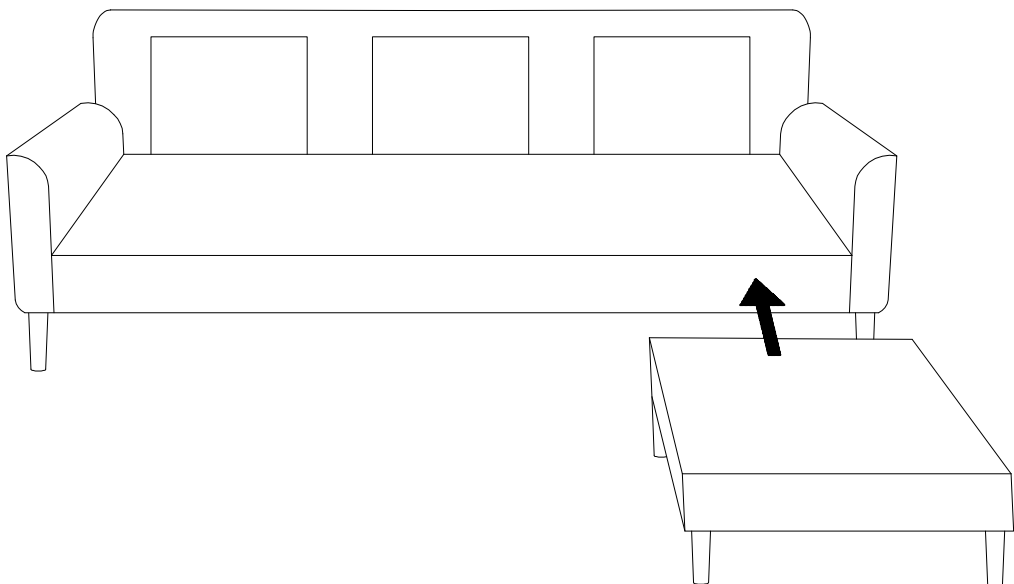

3

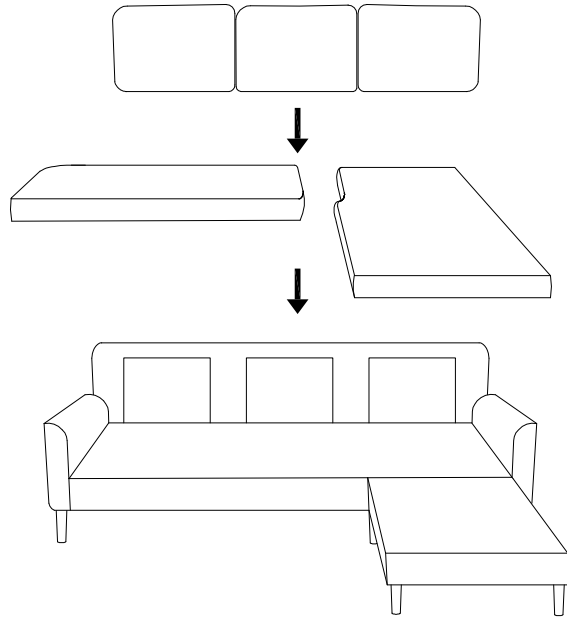
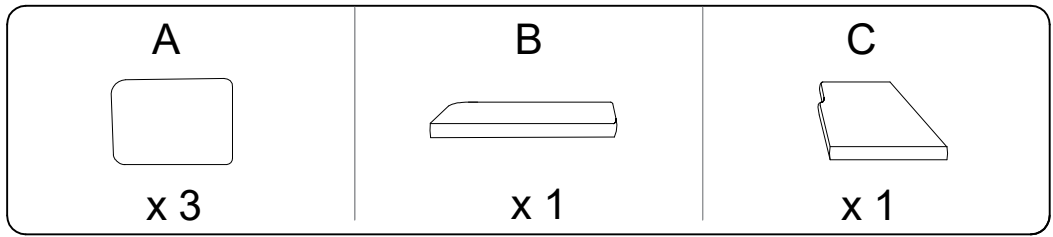

!

