

Pure & Easy



ASSEMBLY INSTRUCTIONS

NOTICE

IMPORTANT, RETAIN FOR FUTURE REFERENCE: READ CAREFULLY
WICHTIG, FÜR SPÄTERE NACHSCHLAGE AUFBEWAHREN: SORGFÄLTIG LESEN
IMPORTANTE, GUARDAR PARA REFERENCIA FUTURA: LEER ATENTAMENTE
IMPORTANTE, CONSERVARE PER RIFERIMENTI FUTURI: LEGGERE ATTENTAMENTE
IMPORTANT, À CONSERVER POUR RÉFÉRENCE FUTURE : LIRE ATTENTIVEMENT

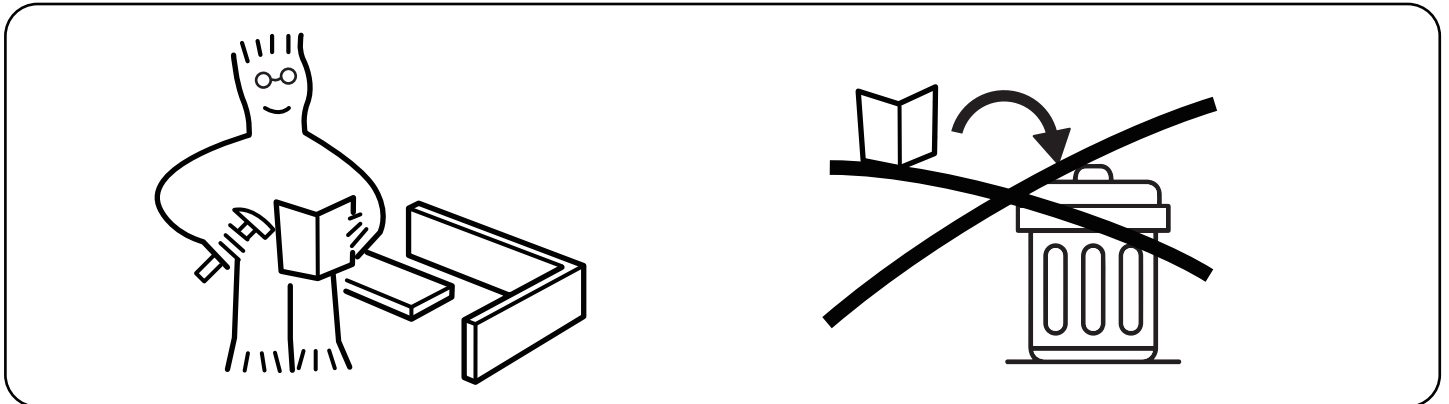

Assemble on a flat and solid surface. To avoid the unstable surface affecting the overall frame stability during installation.

Montieren Sie auf einer ebenen und festen Oberfläche. Um zu verhindern, dass eine unebene Oberfläche während der Montage die Gesamtrahmen-Stabilität beeinträchtigt.

Ensamblar en una superficie plana y sólida. Afin d'éviter que la surface inégale n'affecte la stabilité générale du cadre lors de l'installation.

Assemblare su una superficie piana e solida. Per evitare che una superficie irregolare influisca sulla stabilità complessiva della struttura durante l'installazione.

Assemble sur une surface plate et solide. Para evitar que la instalación en una superficie irregular afecte la estabilidad general del marco.

Professional installation is highly recommended.
Eine professionelle Installation wird dringend empfohlen.
Une installation professionnelle est fortement recommandée.
Si raccomanda vivamente l'installazione professionale.
Se recomienda altamente la instalación profesional.



Periodically Check That All Components Are Tightly Secured.
Überprüfen Sie Regelmäßig, Dass Alle Komponenten Fest Gesichert Sind.
Vérifiez Périodiquement Que Tous Les Composants Sont Bien Fixés.
Controllare Periodicamente Che Tutti I Componenti Siano Ben Fissati.
Verifique Periódicamente Que Todos Los Componentes Estén Bien Asegurados.





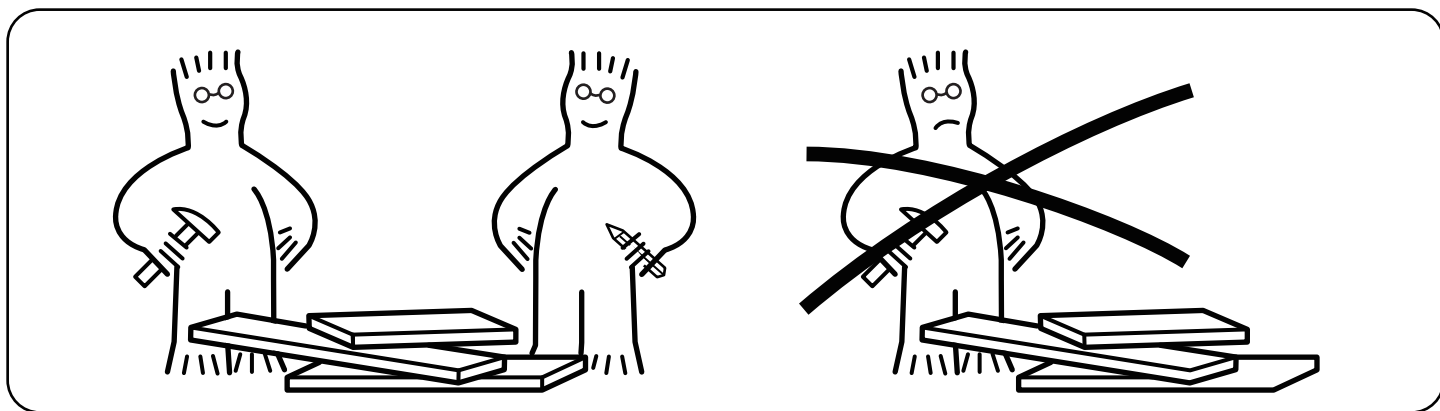



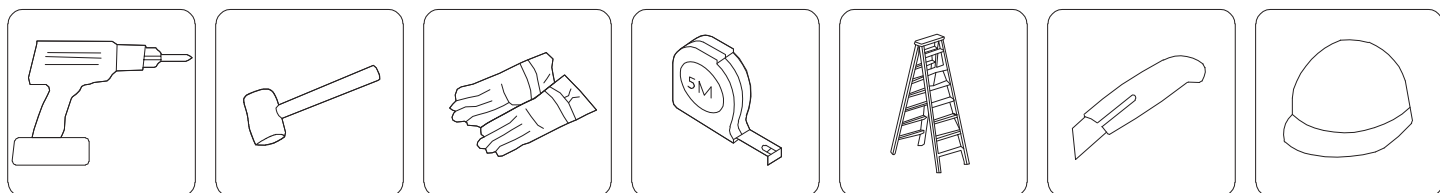



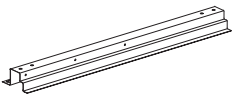
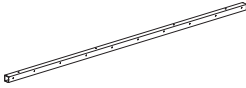

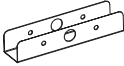
It is recommended that multiple people assemble this product.
Es wird empfohlen, dass mehrere Personen dieses Produkt zusammenbauen.
Il est recommandé que plusieurs personnes assemblent ce produit.
Si raccomanda che più persone assemblino questo prodotto.
Se recomienda que varias personas ensamblen este producto.

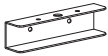
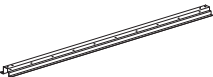

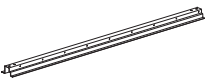
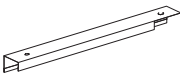
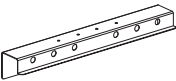

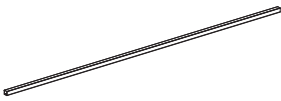

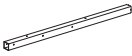
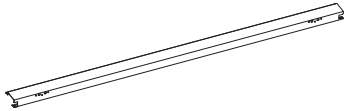

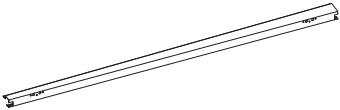
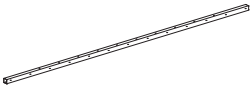
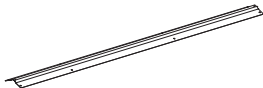
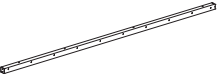
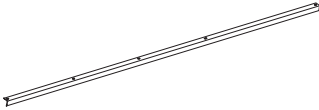

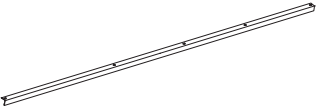





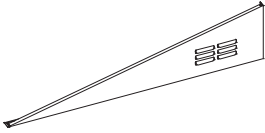

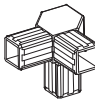
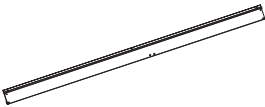

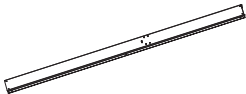
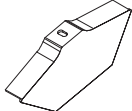
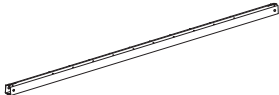

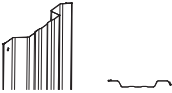
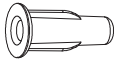
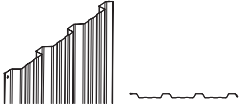

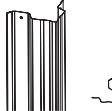

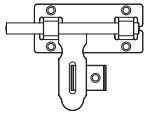
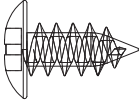
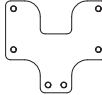

Please have the following auxiliary tools ready:

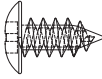
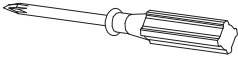
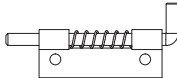
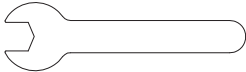
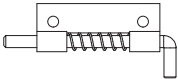

PARTS

Item no.	Reference Image	Qty.	Item no.	Reference Image	Qty.
1L		X1	8R		X1
1R		X1	10		X1
2		X2	10A		X1
3L		X1	11B		X2
3R		X1	11F		X2
4B		X2	15		X4
5		X4	16		X2
6L		X1	17L		X1
6R		X1	17R		X1
7		X2	18		X1
8L		X1	19L		X1

Item no.	Reference Image	Qty.	Item no.	Reference Image	Qty.
19R		X1	W12		X6
20		X4	W15		X2
21		X4	M1		X2
21L		X2	C		X4
21R		X2	F		X4
22		X1	F4		X4
23		X1	F5		X2
25A		X1	F7		X80
W1		X4	F8		X20
W3		X14	F9		X2
W7		X4	S1		X1

Item no.	Reference Image	Qty.	Item no.	Reference Image	Qty.
S2		X1	S8	 M5 X 16mm	X4
S3		X1	S9		X4
S4	 M4 X 10mm	X260	S12		X1
S5L		X1	S15		X1
S5R		X1	S35		X1
S6	 M4 X 8mm	X55	Q17		X2
S6A		X10	Q20		X2
S7	 M4	X59	Q37		X2

EXPLODED VIEW

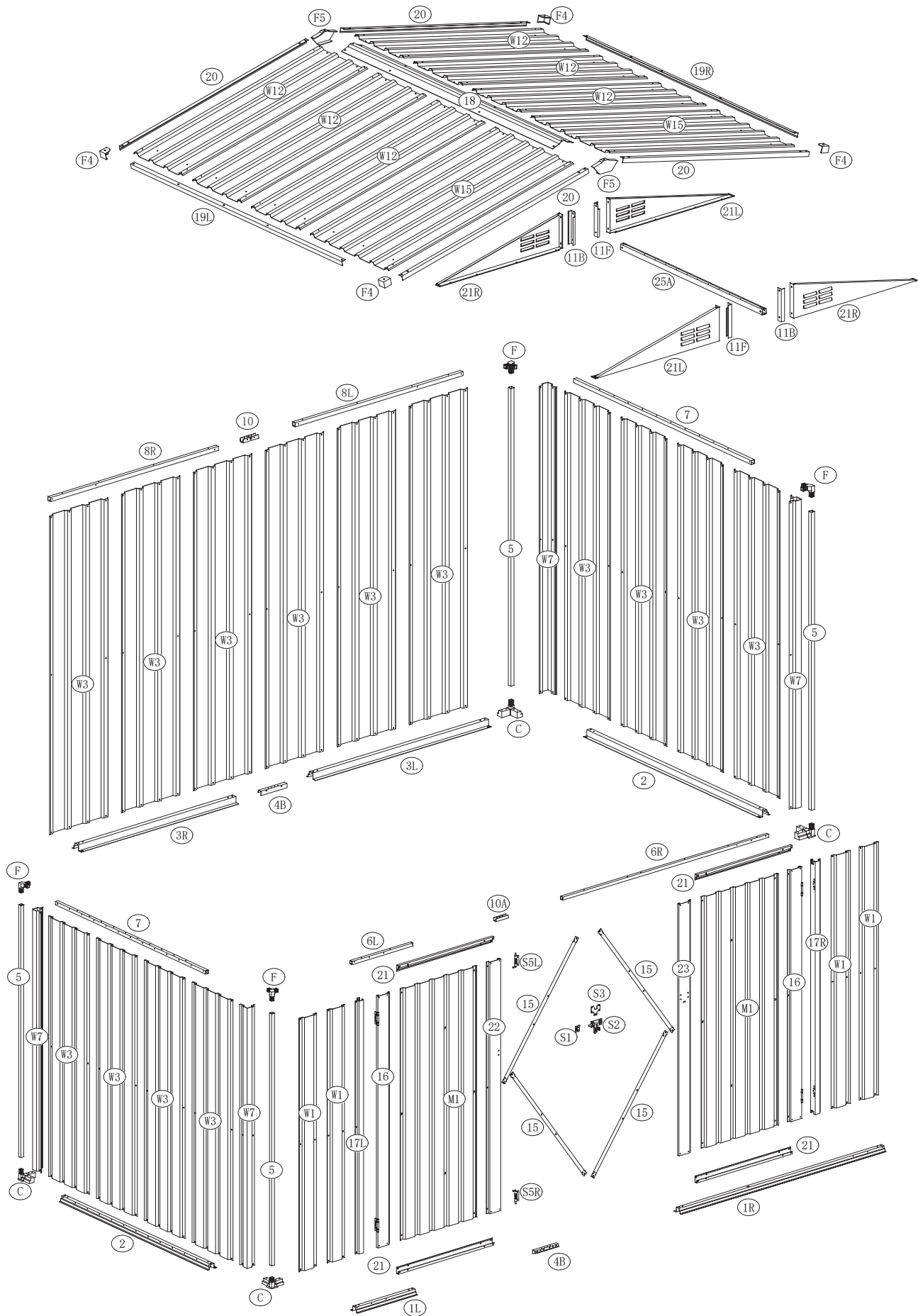

ASSEMBLY

1

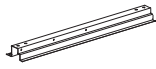

①L 1pc



①R 1pc

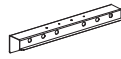

④B 1pc



⑤S4 4pcs

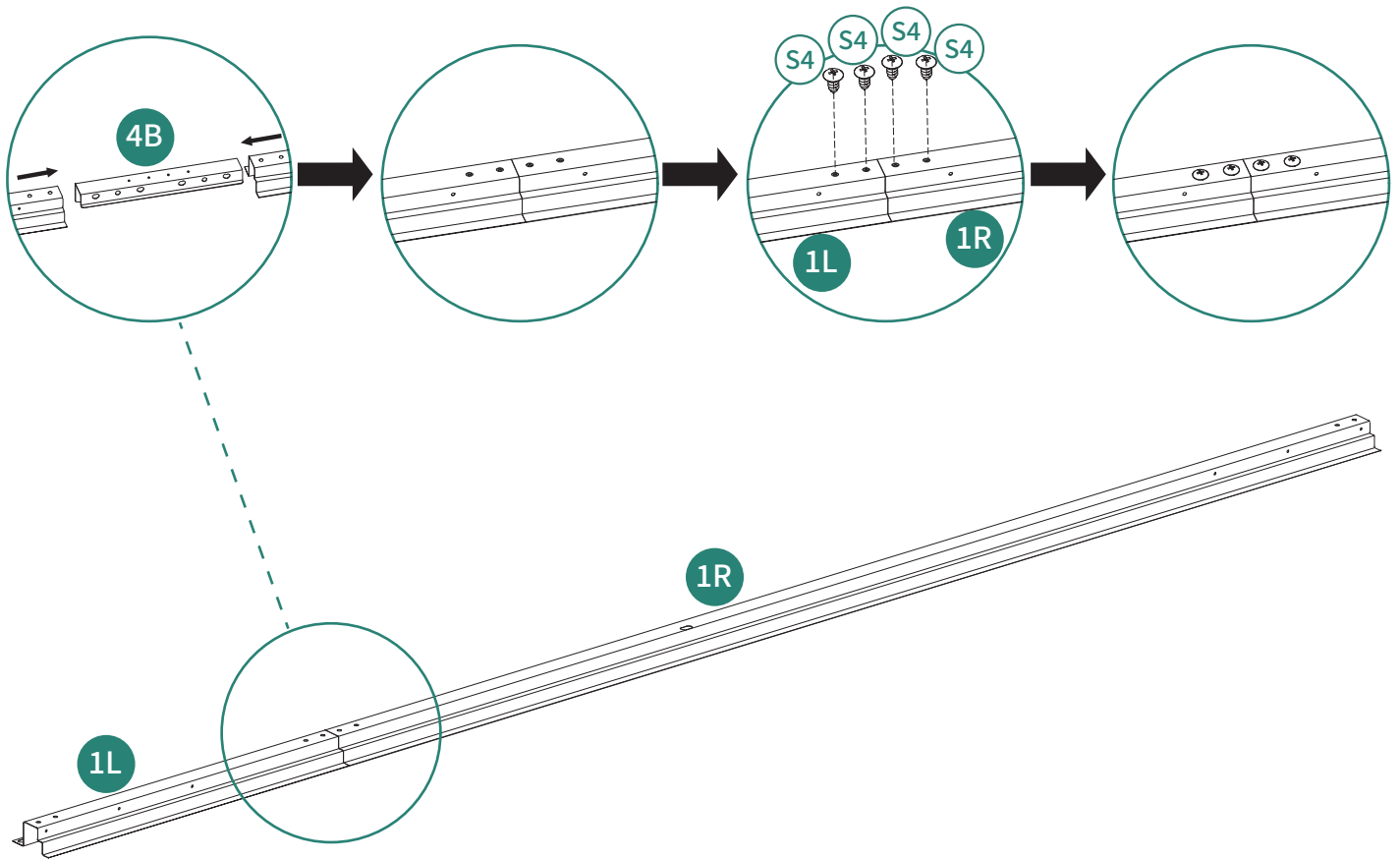

2



3L 1pc



3R 1pc

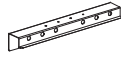

4B 1pc



S4 4pcs

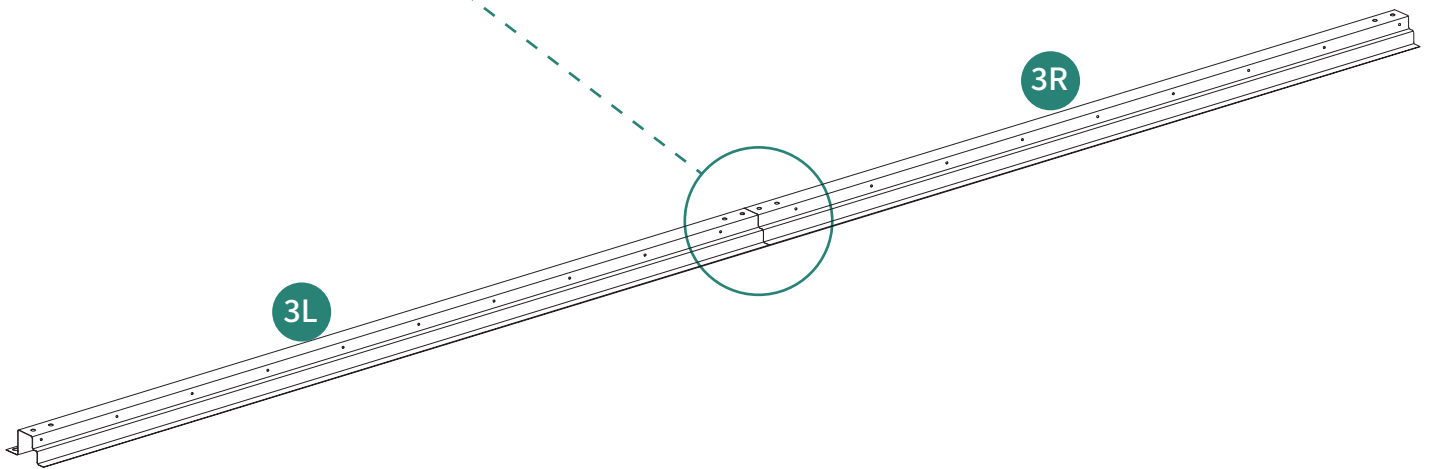
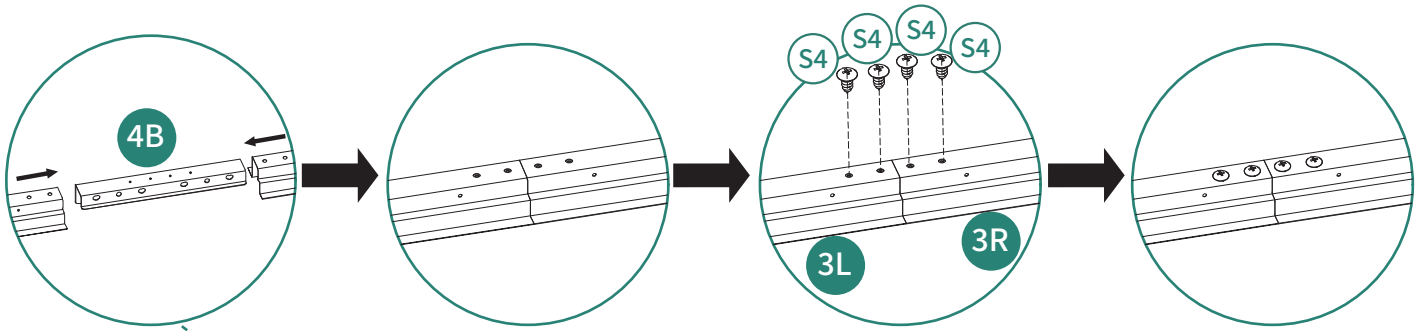

3



② 2pcs



④ 4pcs

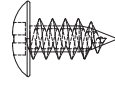

⑬ 16pcs

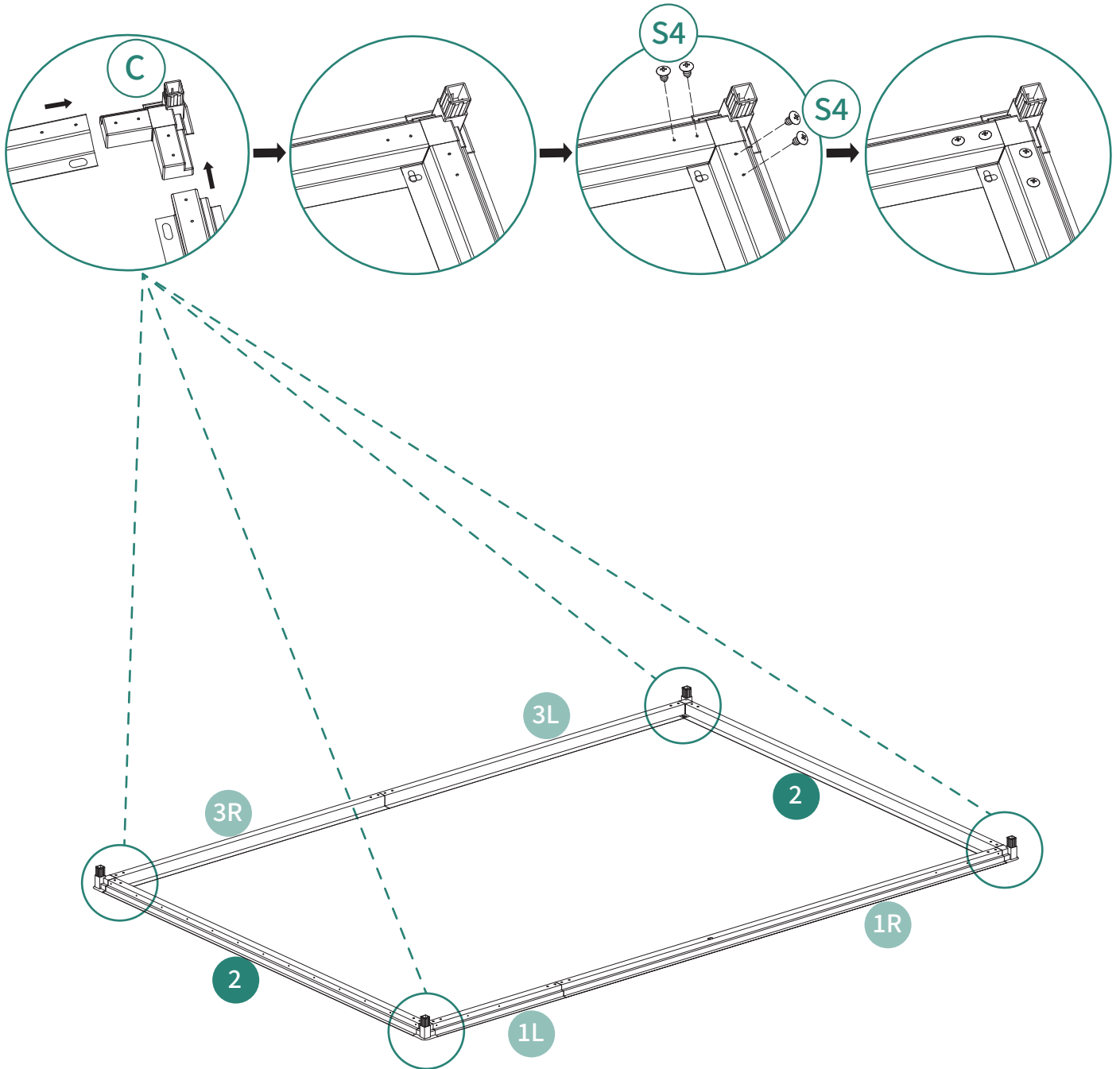

4

⑤ 4pcs

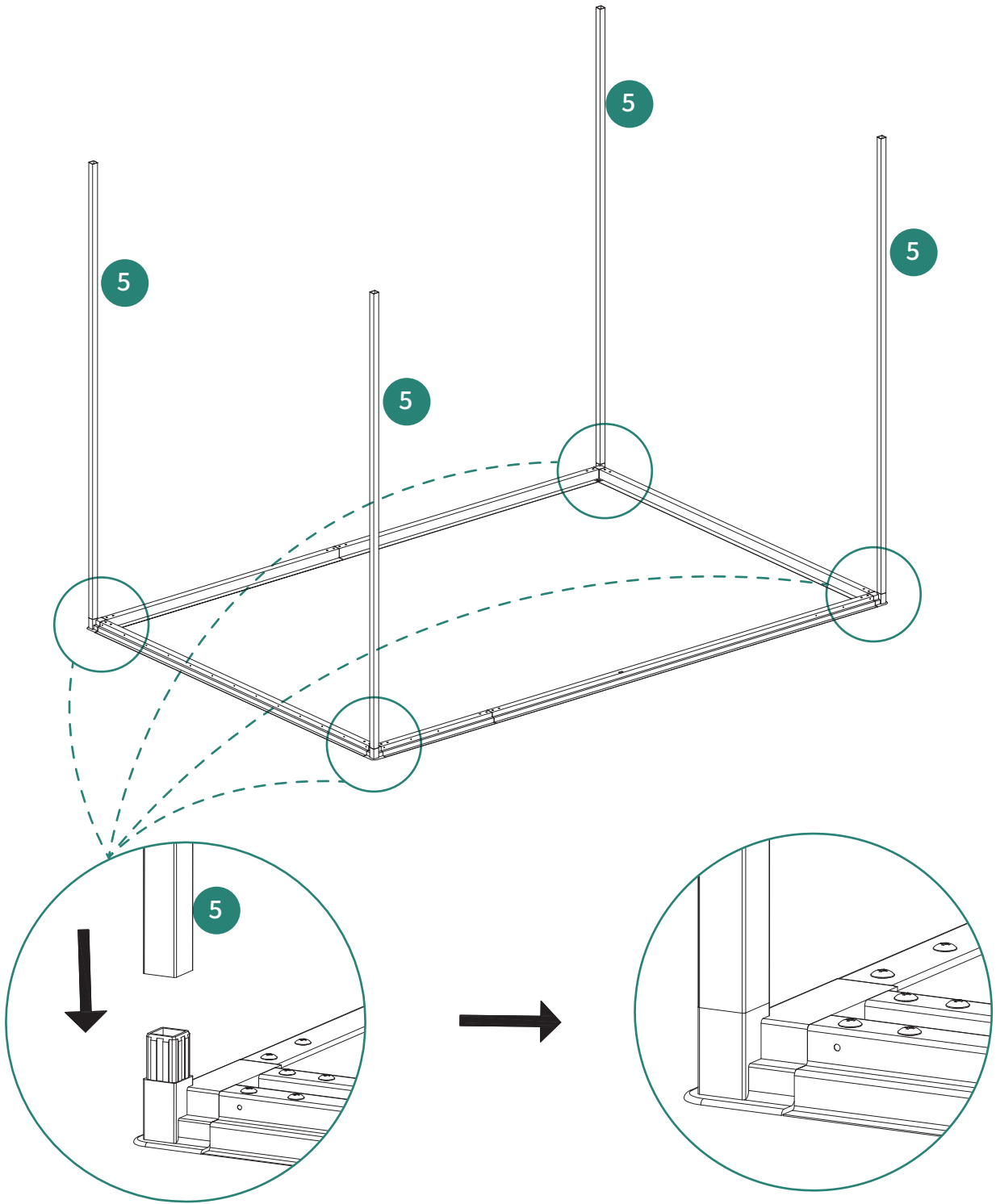

6



⑥L 1pc



⑥R 1pc



⑩A 1pc



④S 4pcs

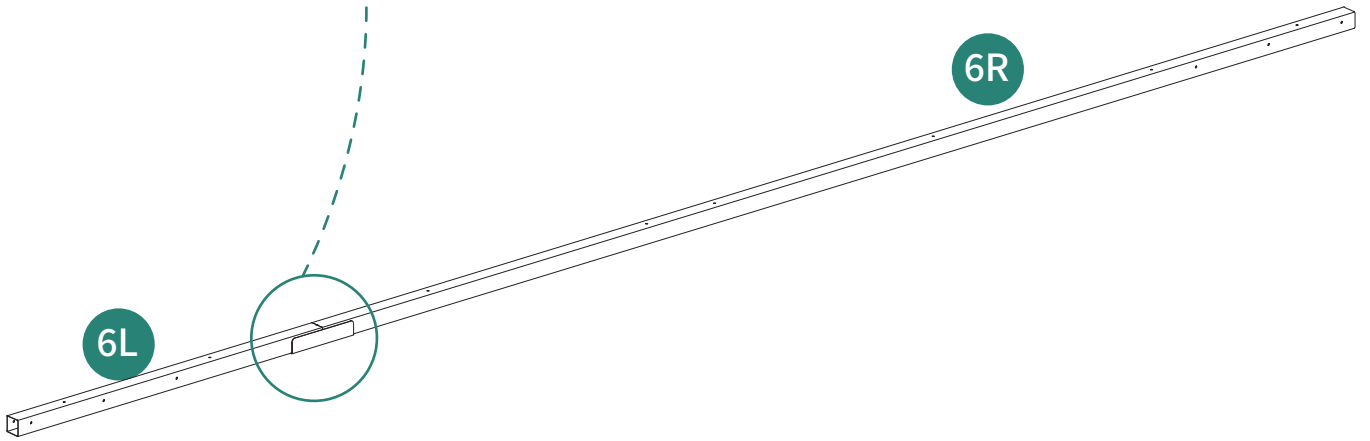
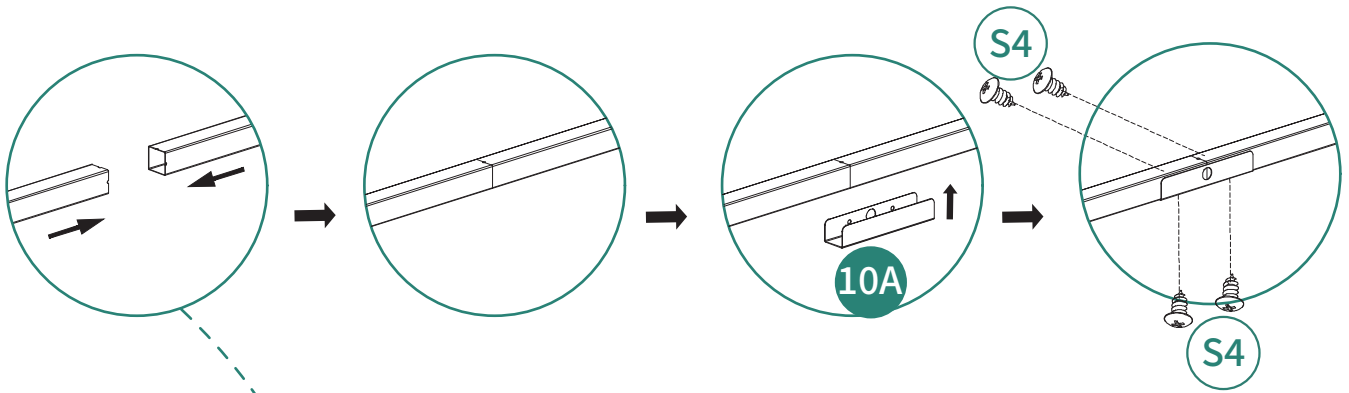

7

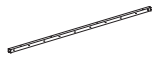

⑧L 1pc

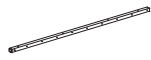

⑧R 1pc



⑩ 1pc



④S 4pcs

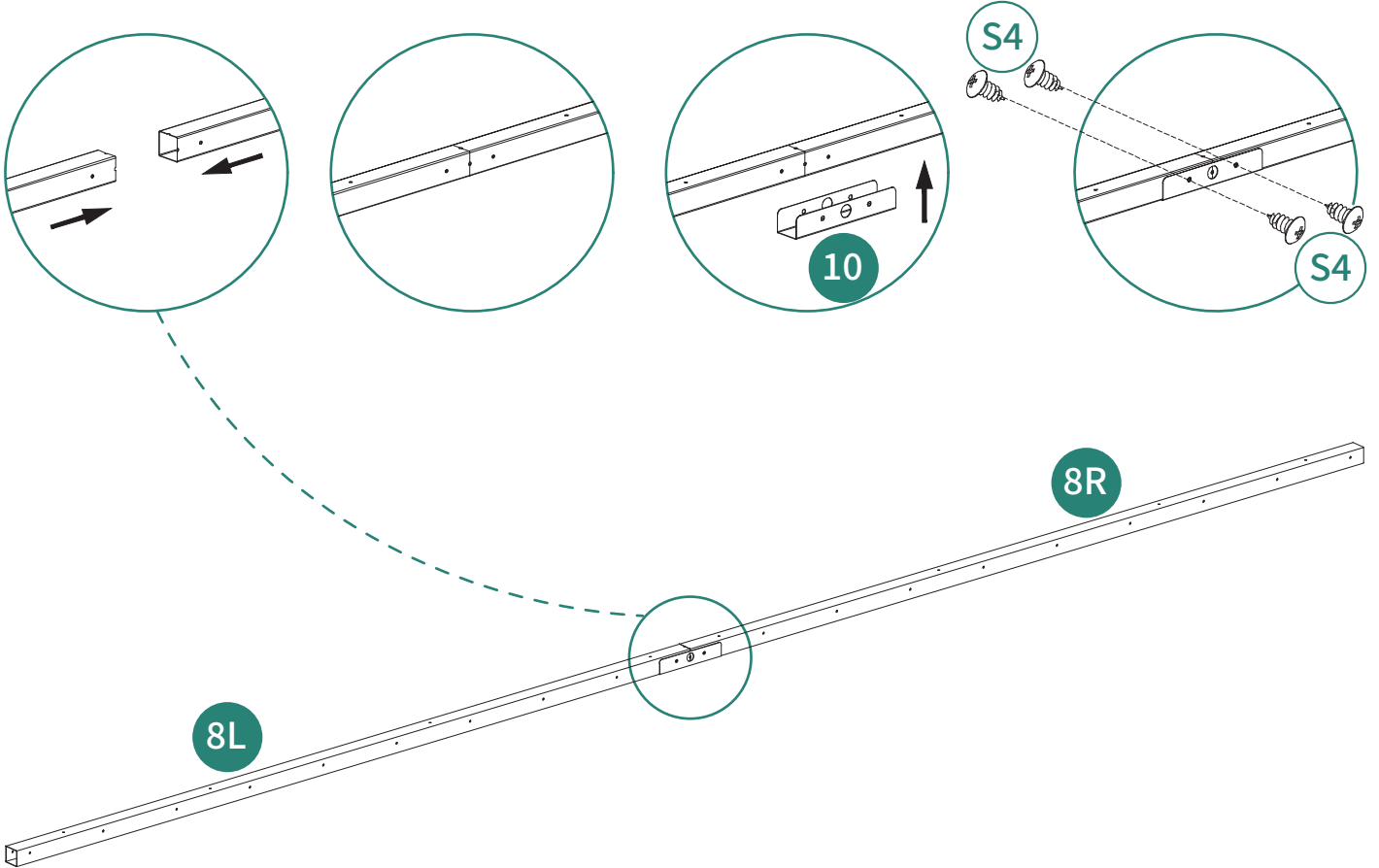

8



⑦ 2pcs

④ F 4pcs

④ S4 8pcs

NOTES:

When assembling the beam:

1. Make sure parts (7, 8L, 8R) have the sides with closely spaced holes facing outward, and the sides with widely spaced holes facing upward.
2. Ensure parts (6L, 6R) have the sides with rectangular latch lock slot facing downward. Part 6L should be on the left side and part 6R on the right.

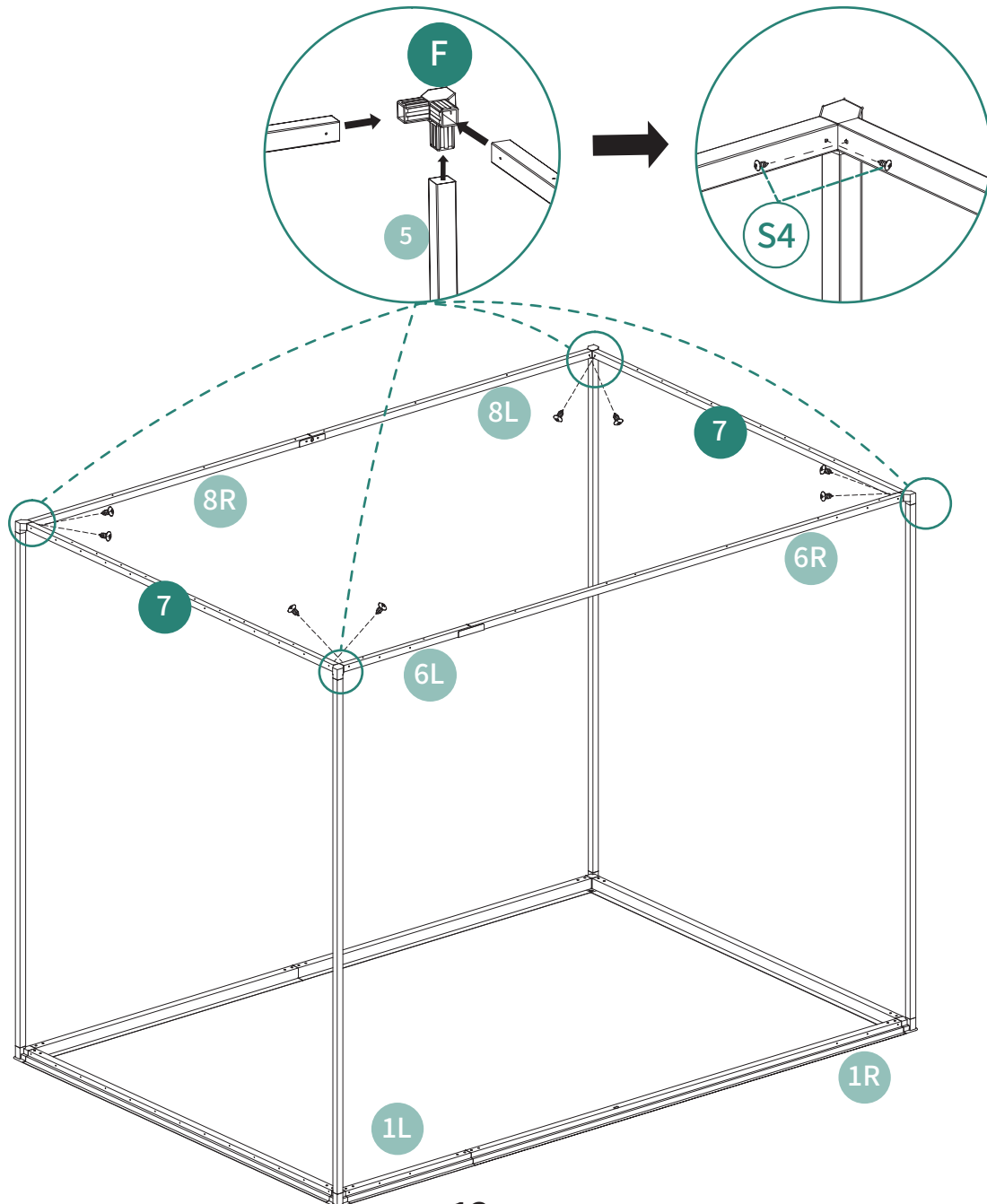

9



W3 4pcs



W7 2pcs



S4 26pcs



S6 5pcs



S7 5pcs

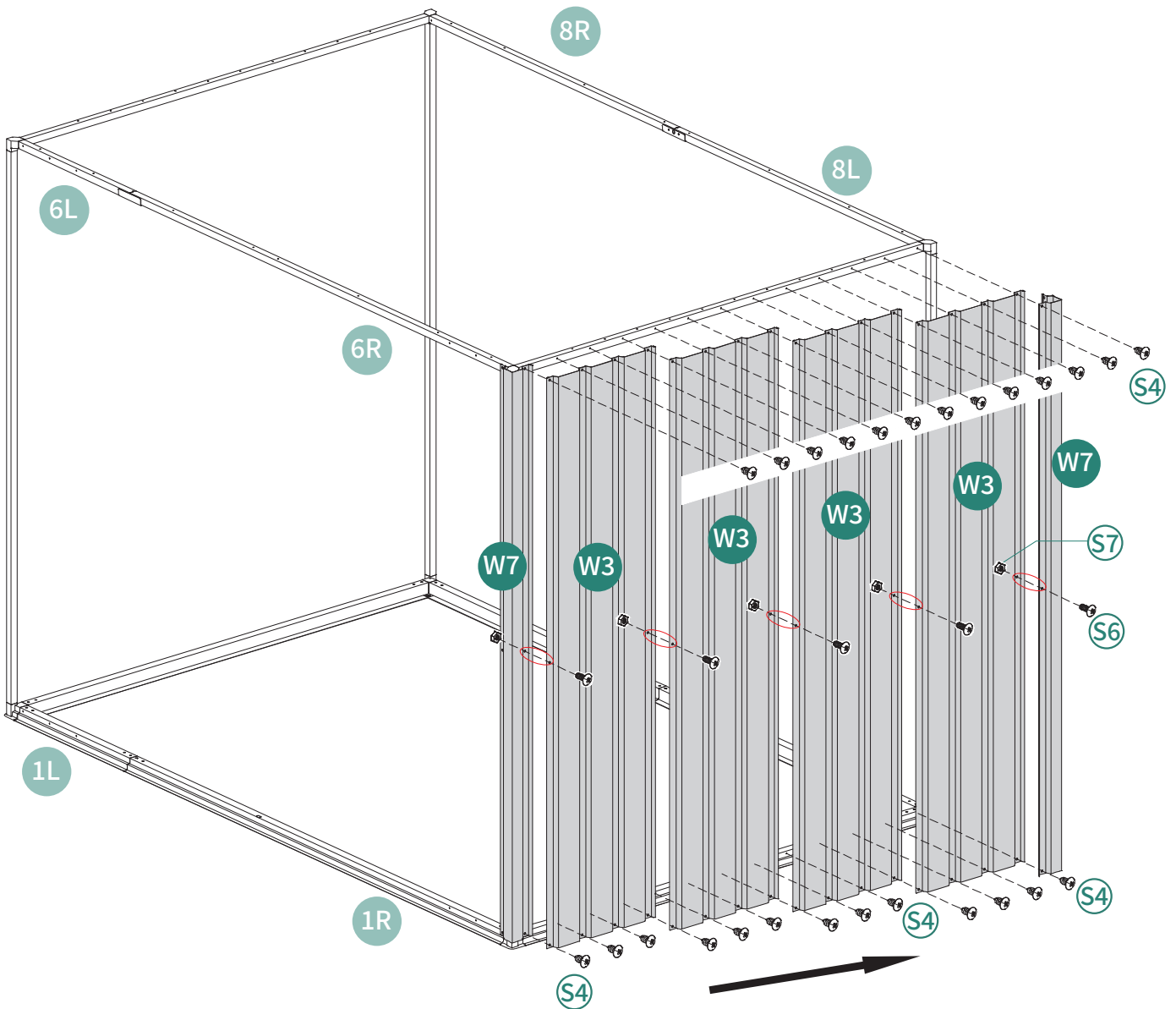

Secure the screws sequentially as indicated by the arrow.

10



W3 6pcs



W7 1pc



S4 38pcs



S6 7pcs



S7 7pcs

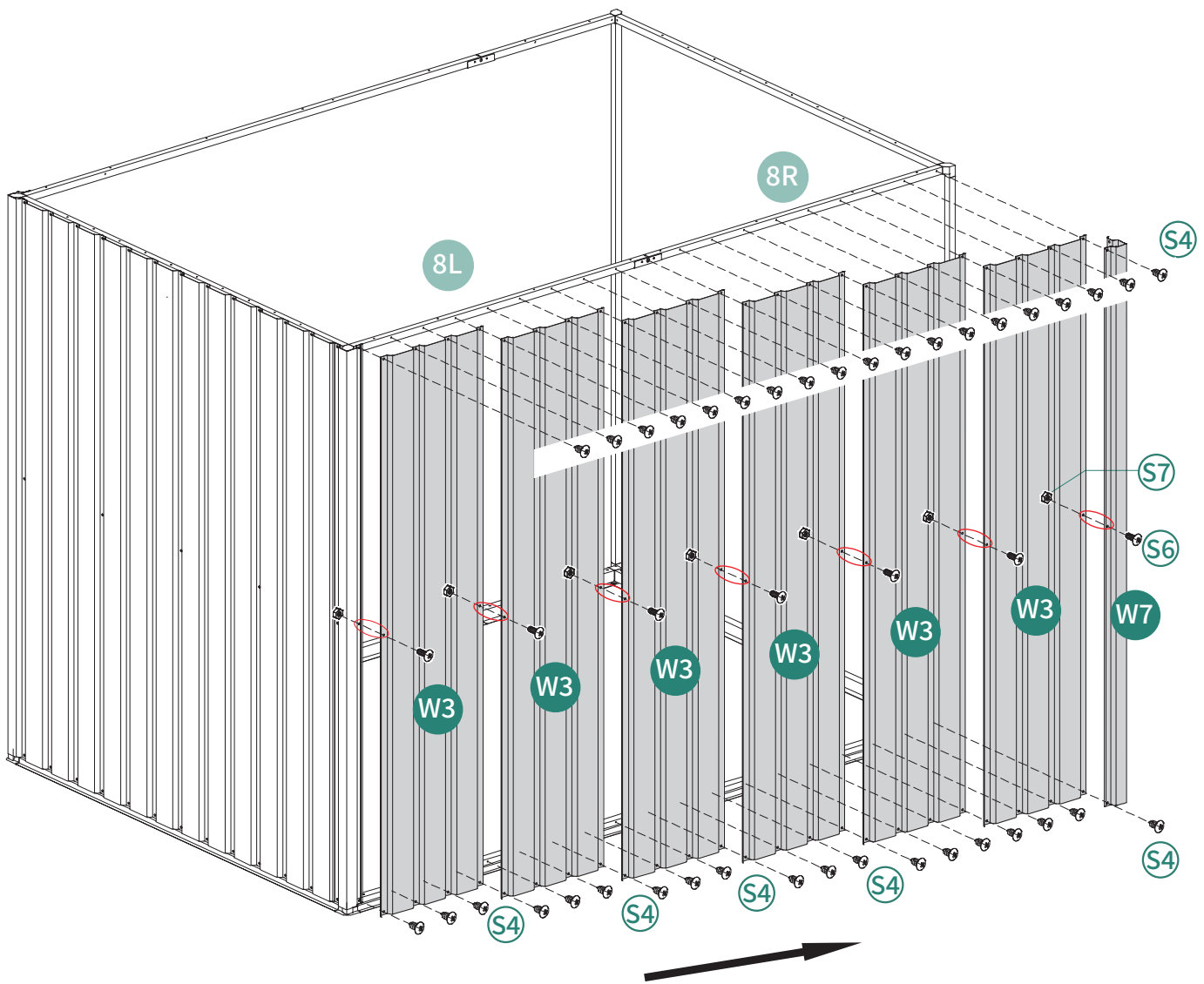

Secure the screws sequentially as indicated by the arrow.

11



W3 4pcs



W7 1pc



S4 26pcs



S6 5pcs



S7 5pcs

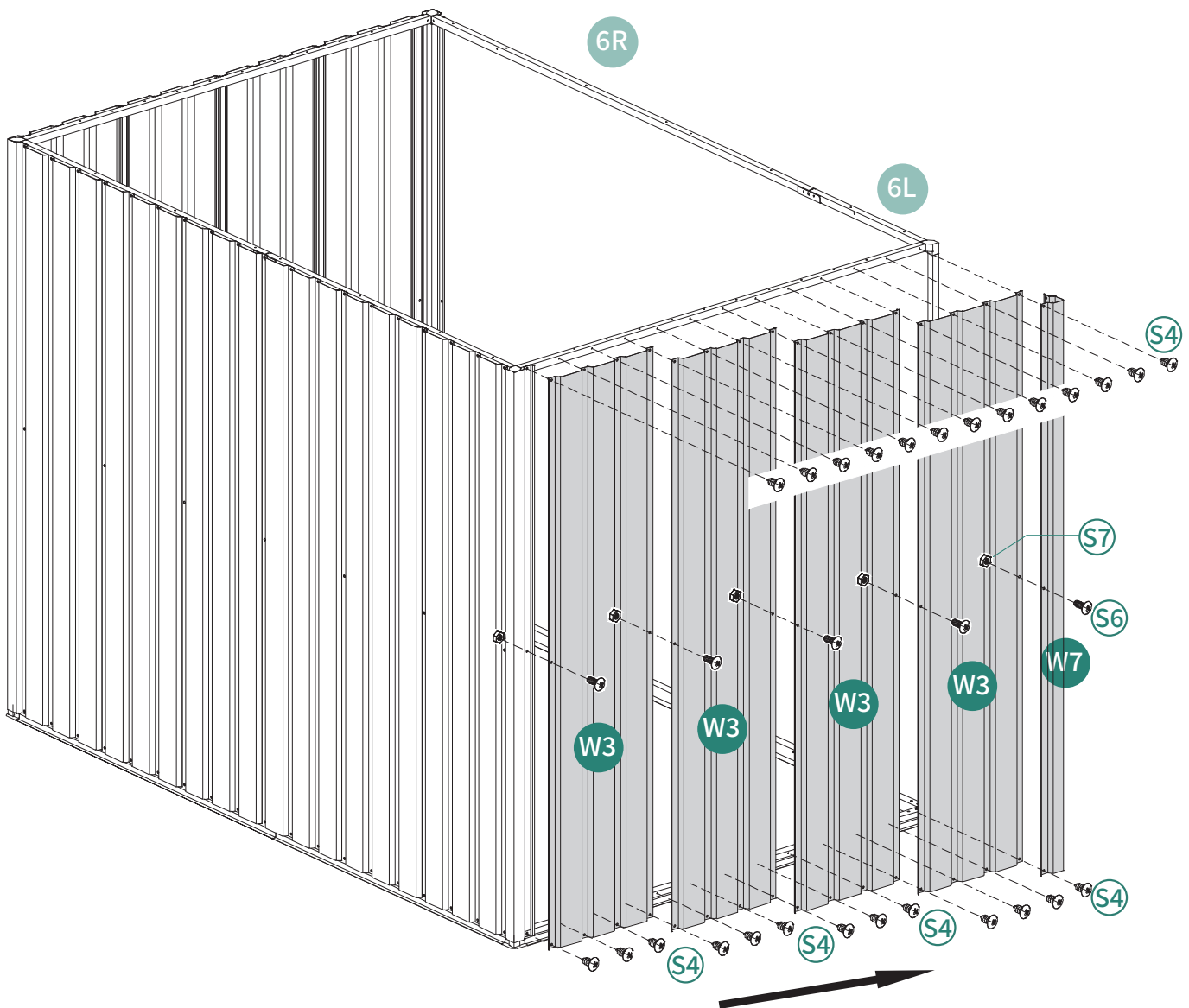

Secure the screws sequentially as indicated by the arrow.

12



W1 4pcs

17L 1pc

17R 1pc

S4 16pcs



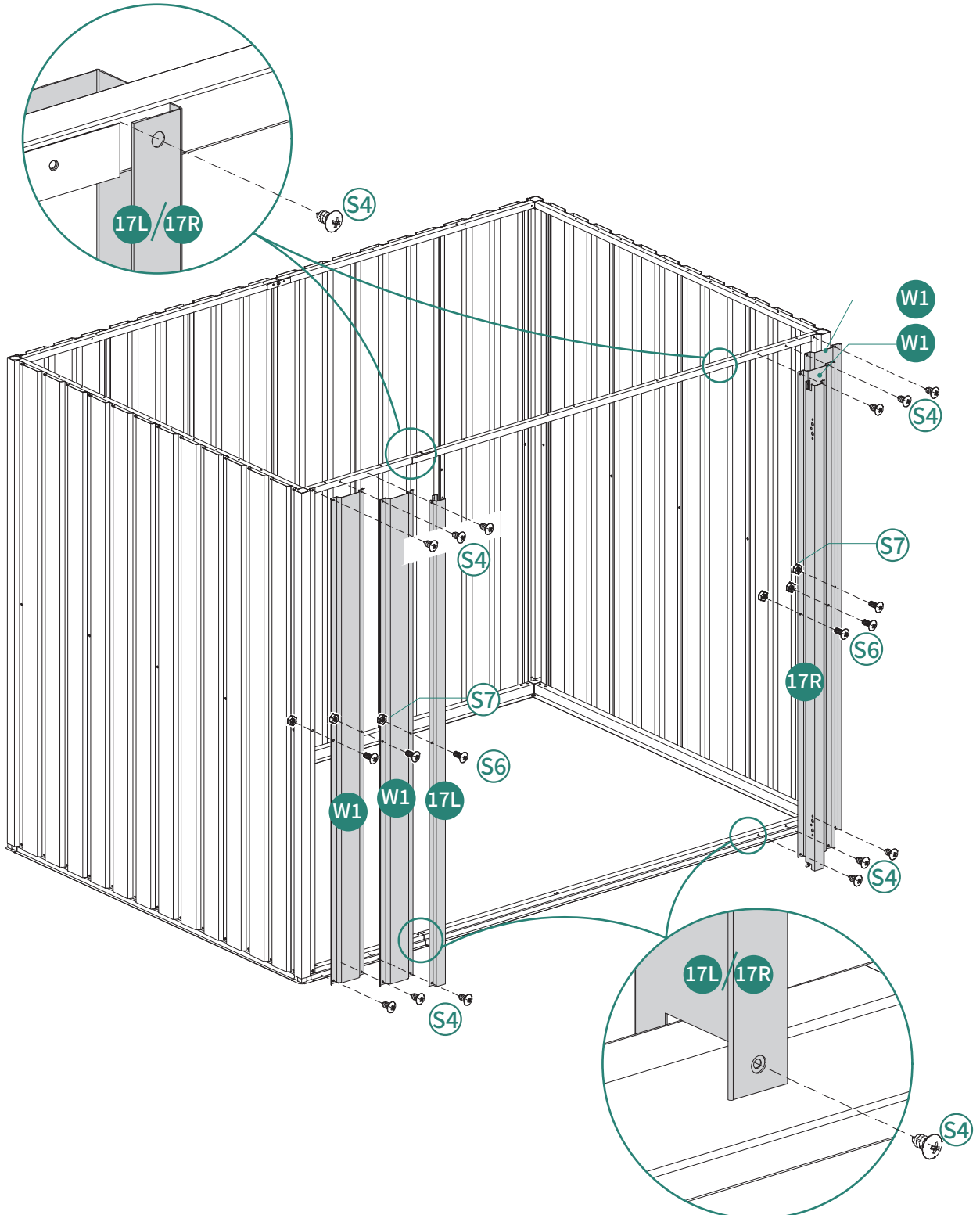

S6 6pcs

S7 6pcs

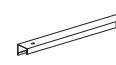

13

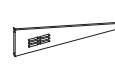
X2

-  11B 2pcs
-  11F 2pcs
-  21L 2pcs
-  21R 2pcs
-  S6 2pcs
-  S7 2pcs

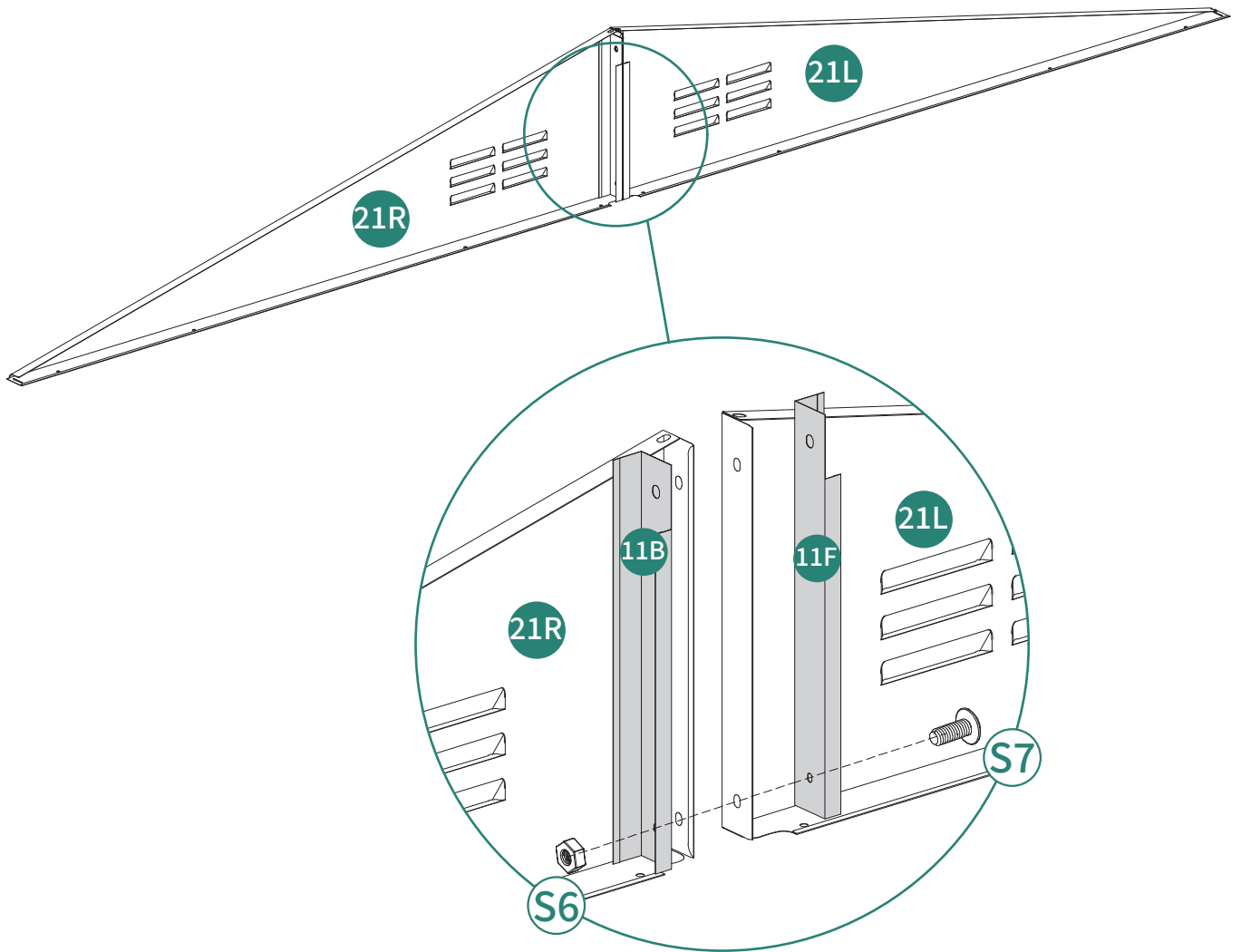

14



S4 16pcs

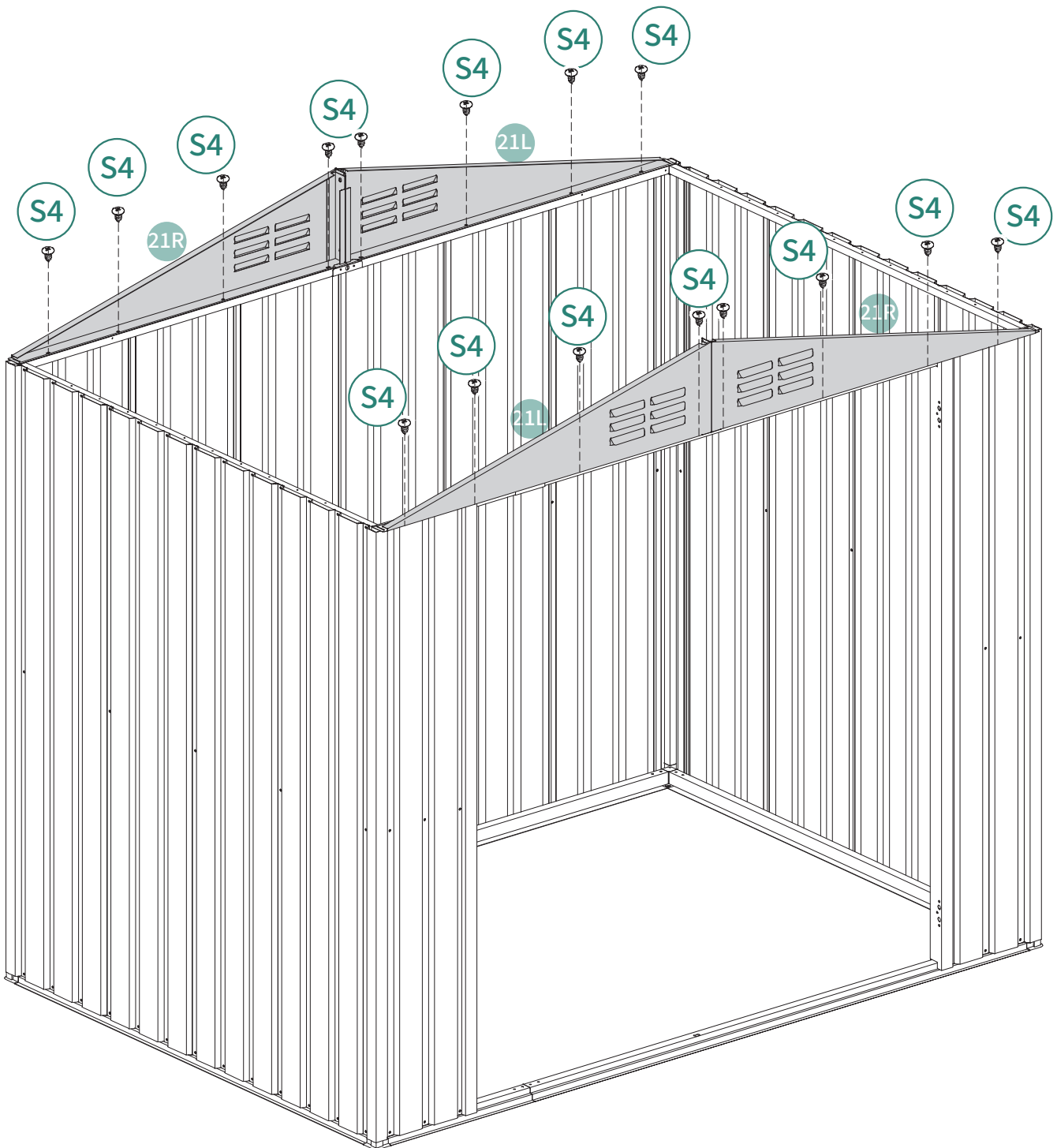

15



25A 1pc



Q37 2pcs





Q17 2pcs

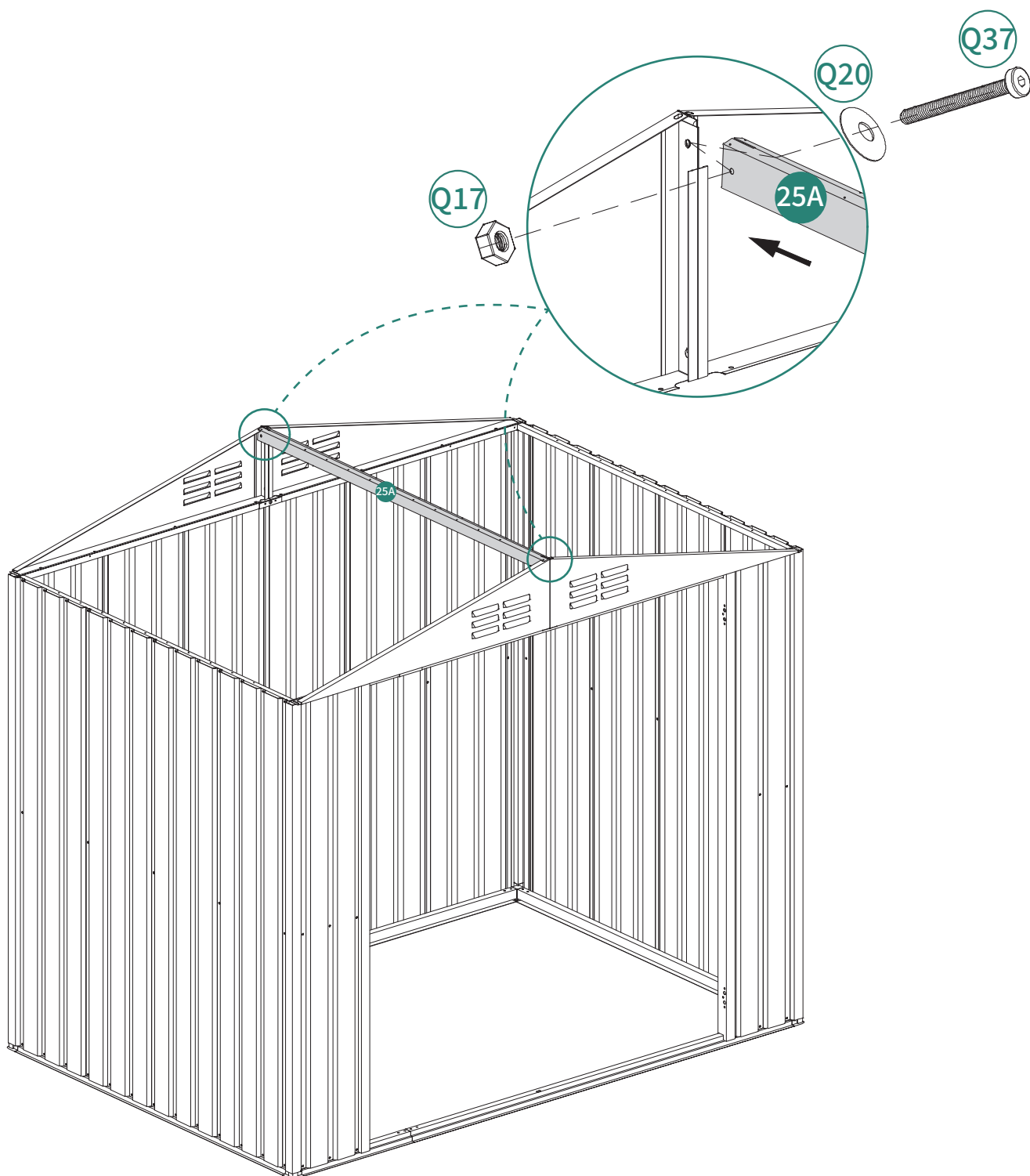

Q20 2pcs

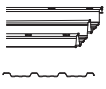
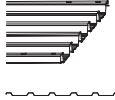

16

-  W12 6pcs
-  W15 2pcs
-  S4 52pcs
-  F7 52pcs

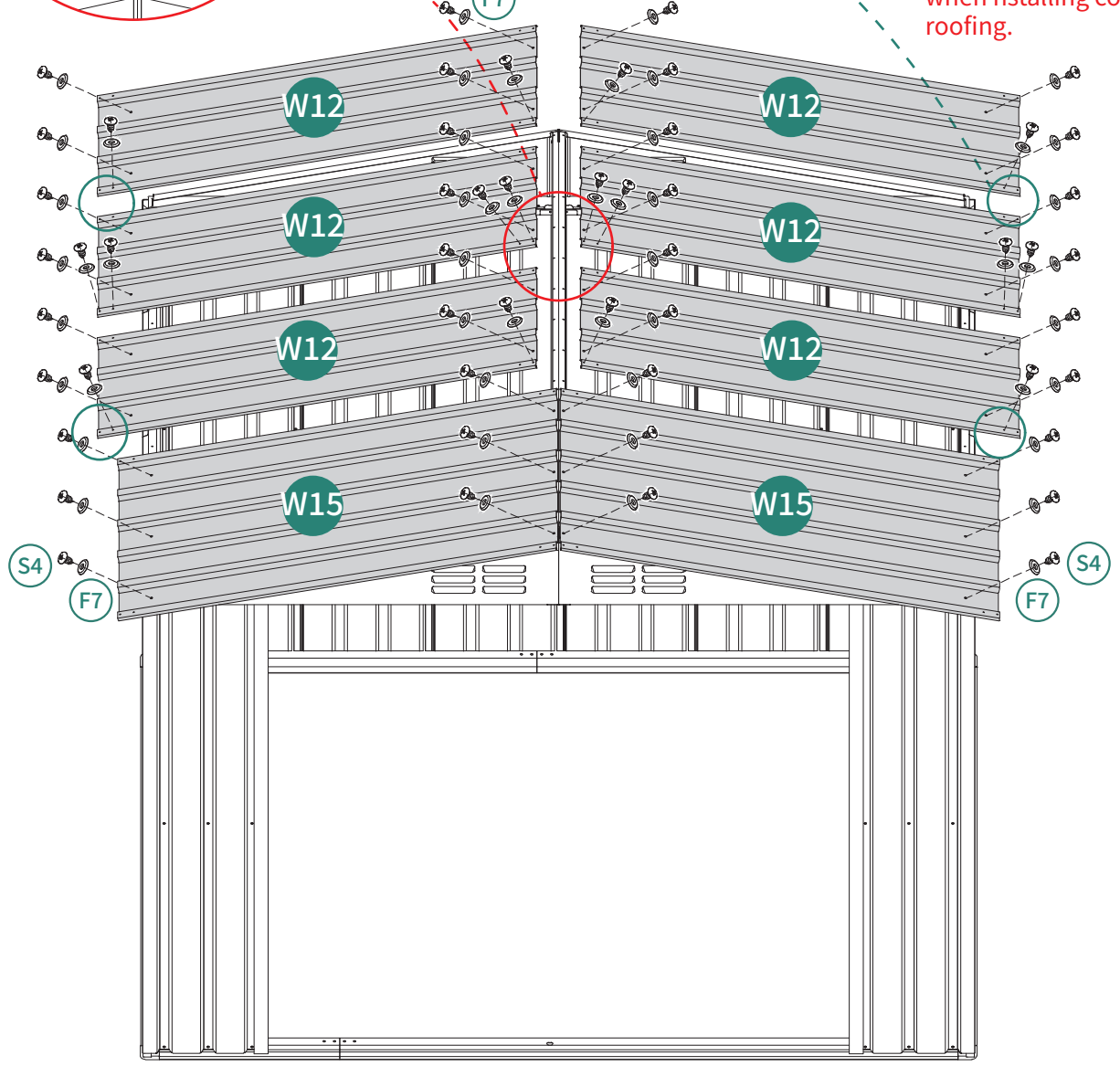
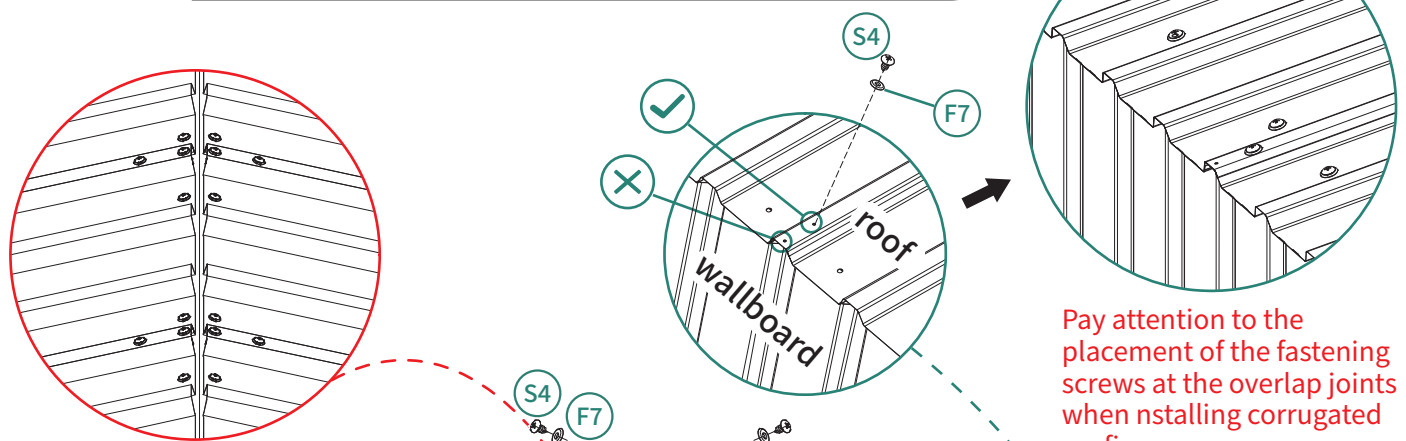

17

-  19L 1pc
-  19R 1pc
-  20 4pcs
-  S4 14pcs
-  S8 4pcs
-  F4 4pcs
-  F7 18pcs

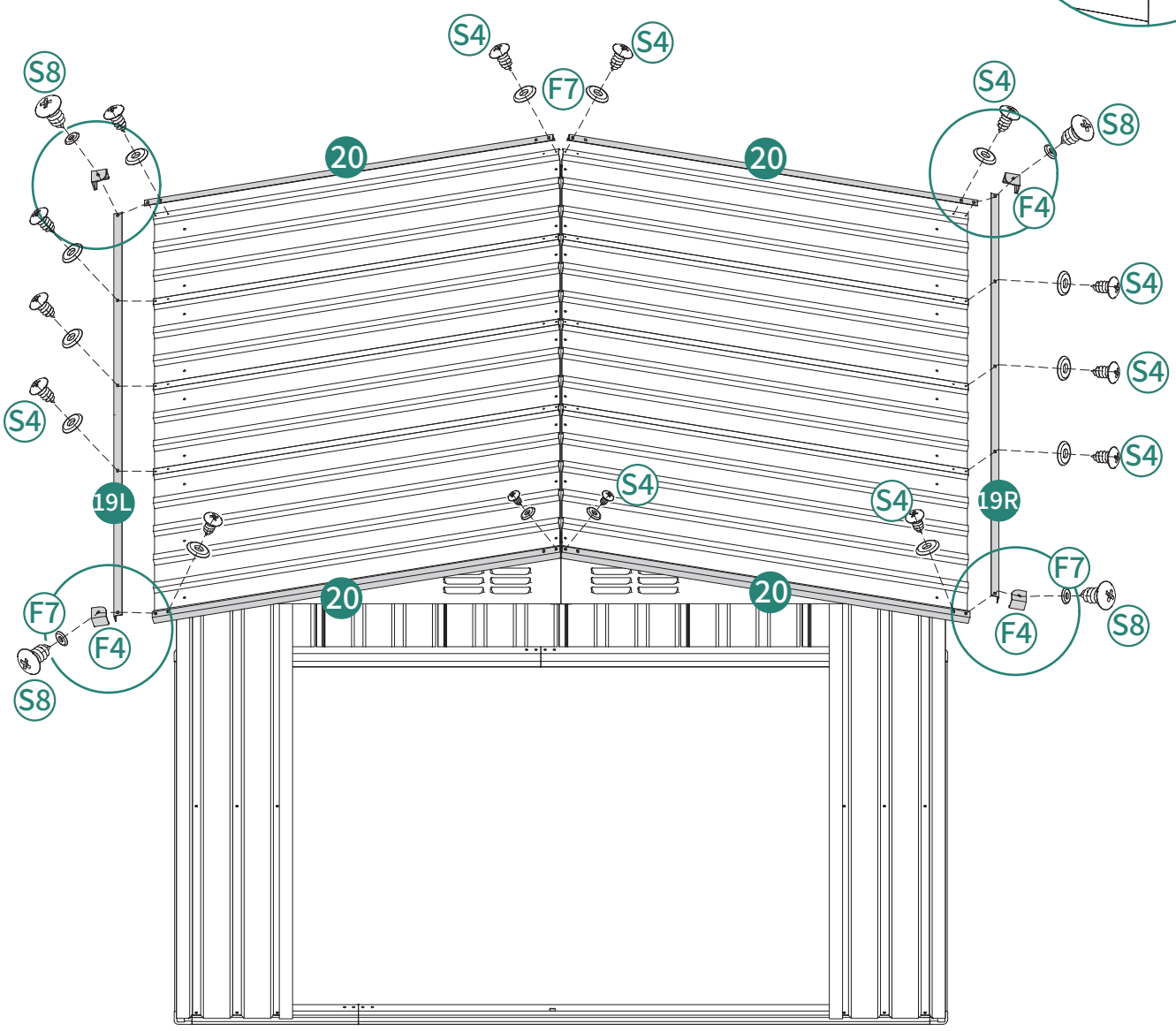
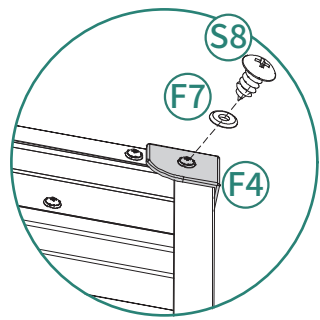

18

F8 40pcs



After fixing the screws, there will be some exposed screw parts on the component. Please use the provided plastic protective covers to protect the exposed screw parts, to avoid scratches during use.

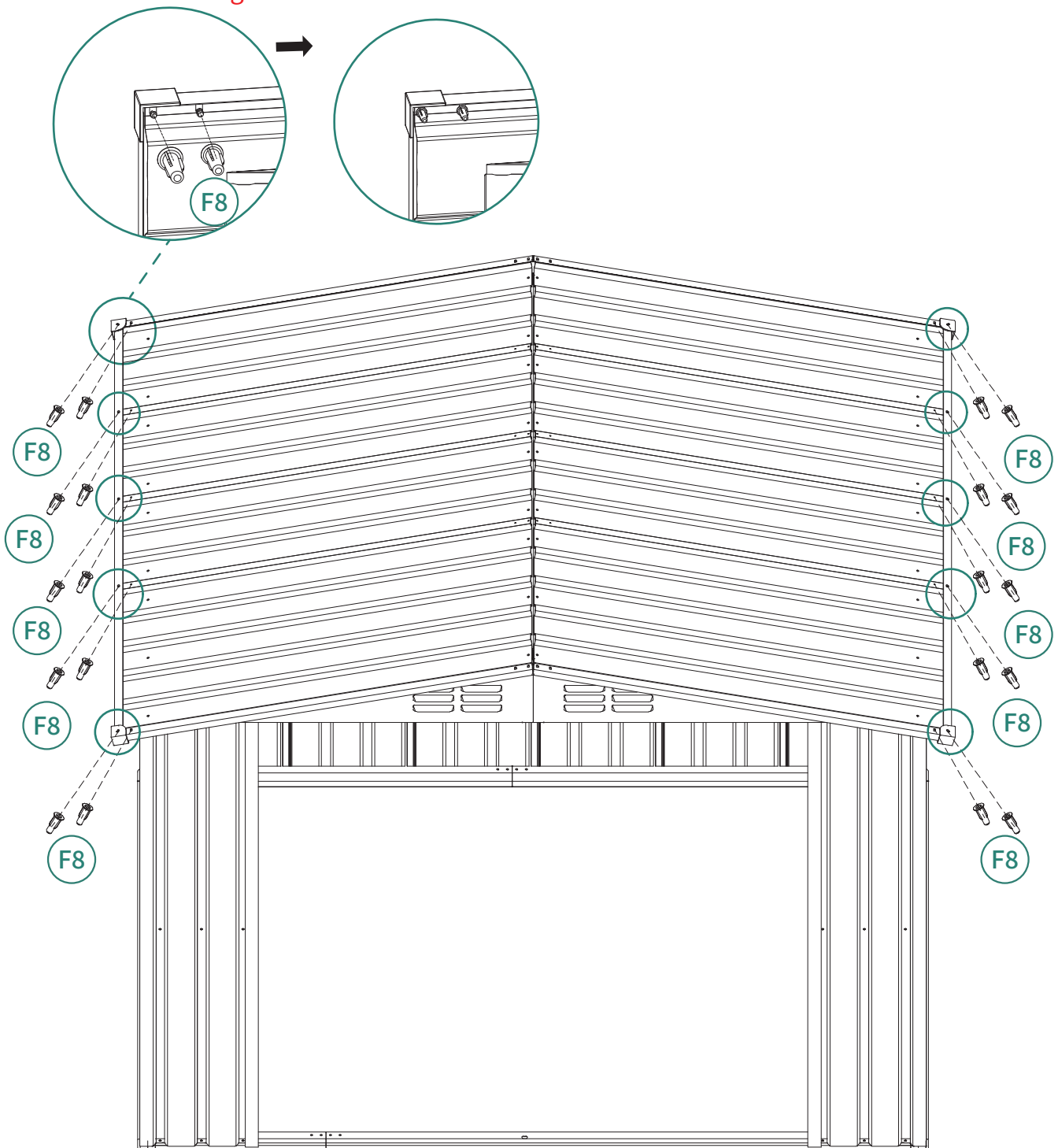

19

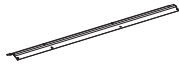

⑱ 1pc

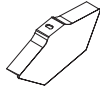

ⓕ5 2pcs



Ⓢ4 10pcs



ⓕ7 10pcs

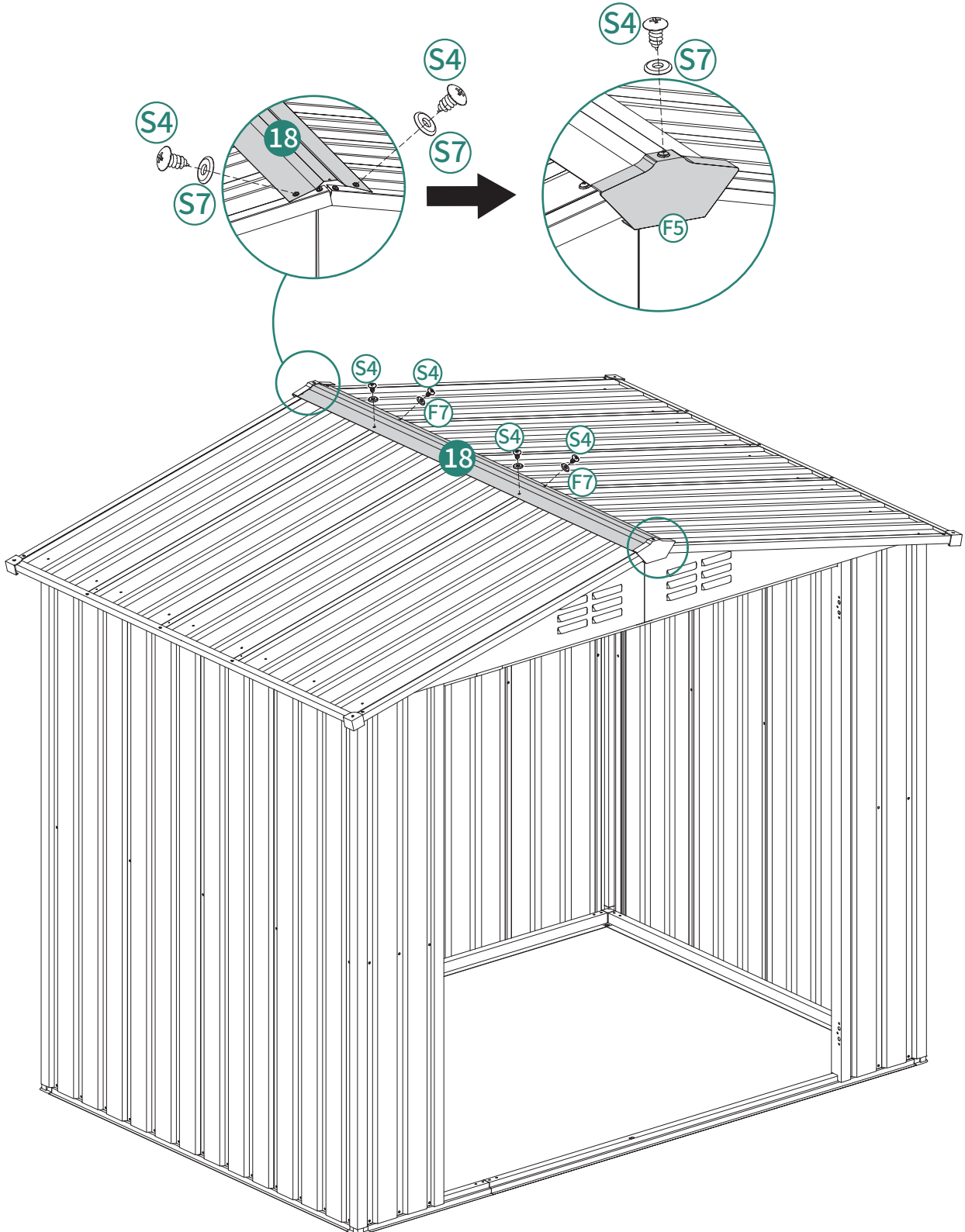

20

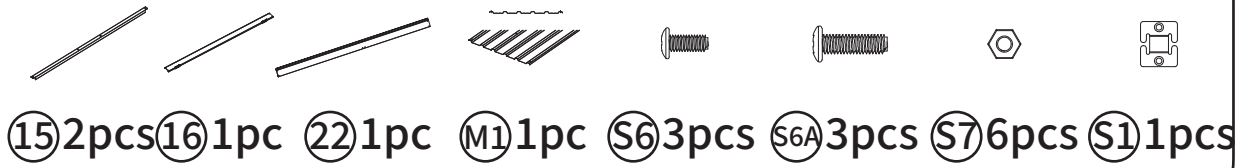

Install part 16 to the side of part M1 (front side panel) with the longer distance from the center screw hole to the edge, and part 22 to the side with the shorter distance.

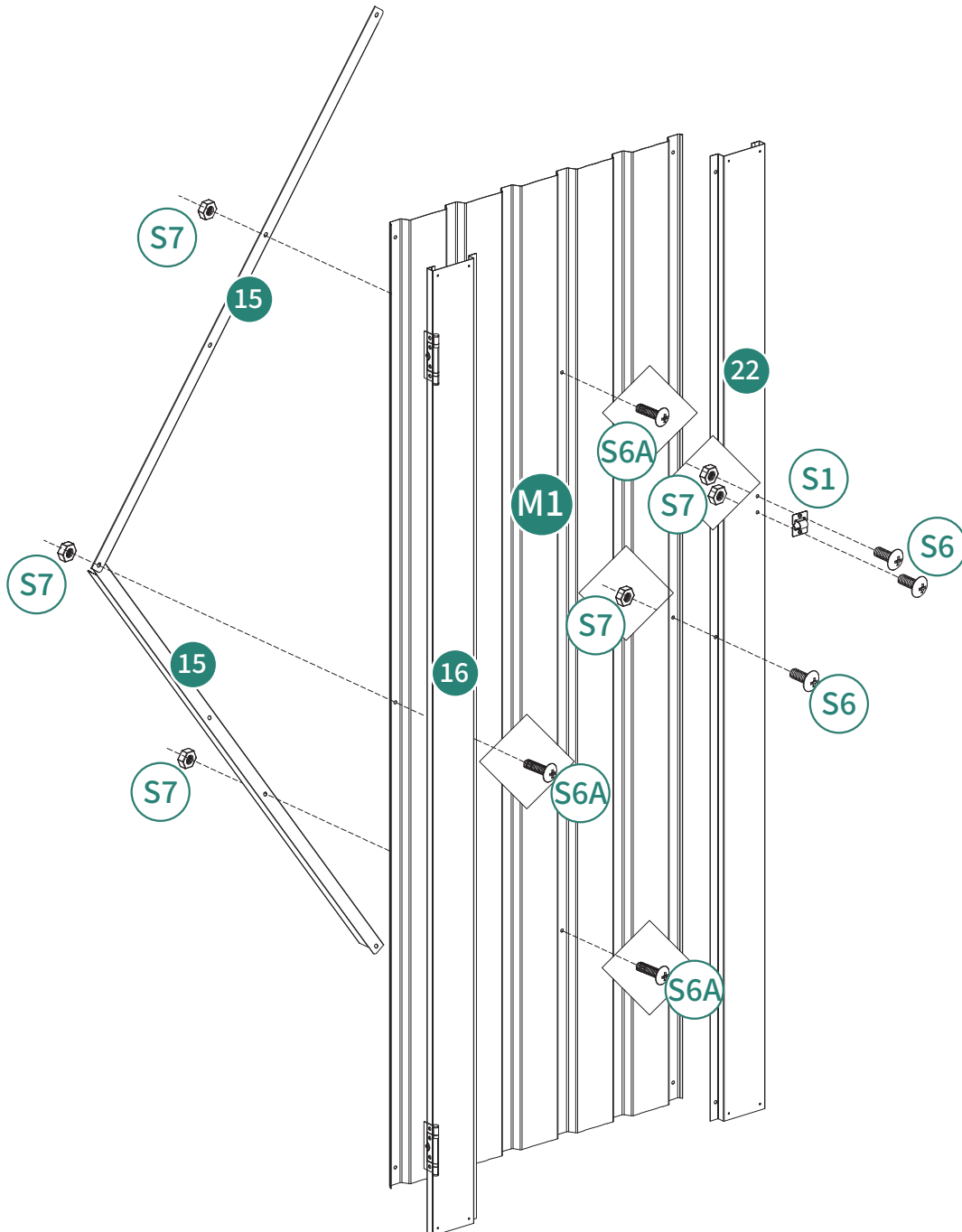

21



21 2pcs

S4 8pcs

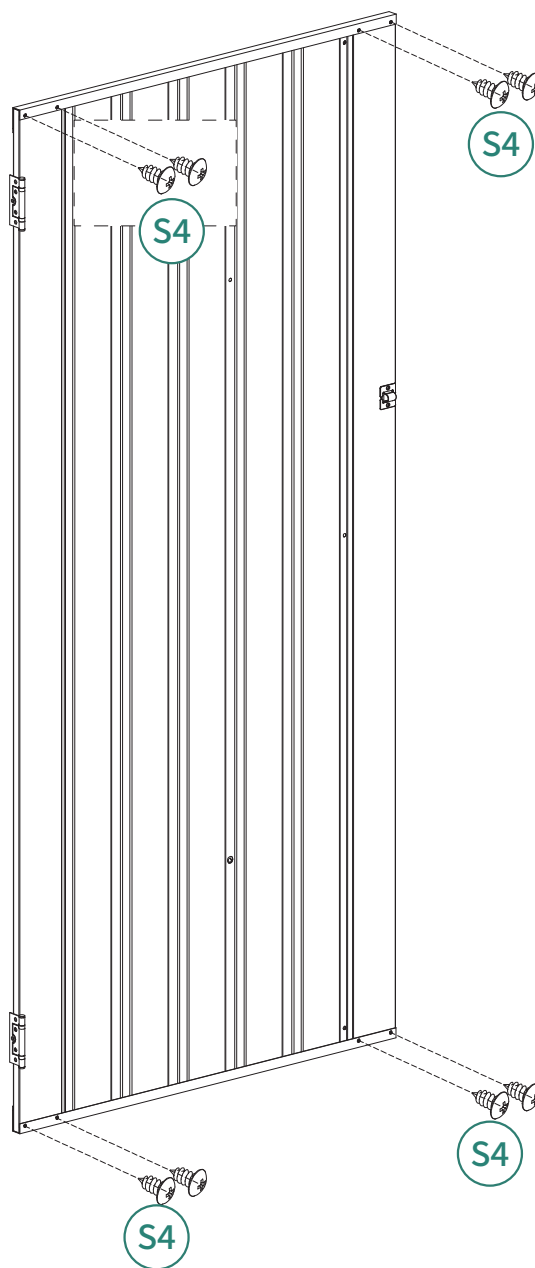
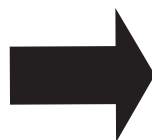
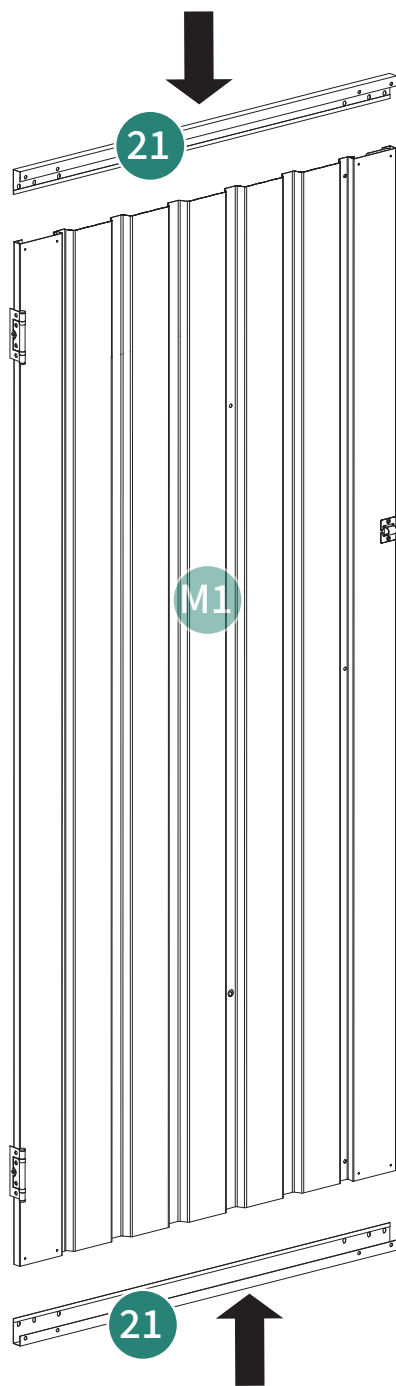

22



S4 2pcs

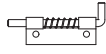

S5L 1pc

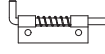

S5R 1pc



S6 6pcs



S6A 2pcs



S7 8pcs

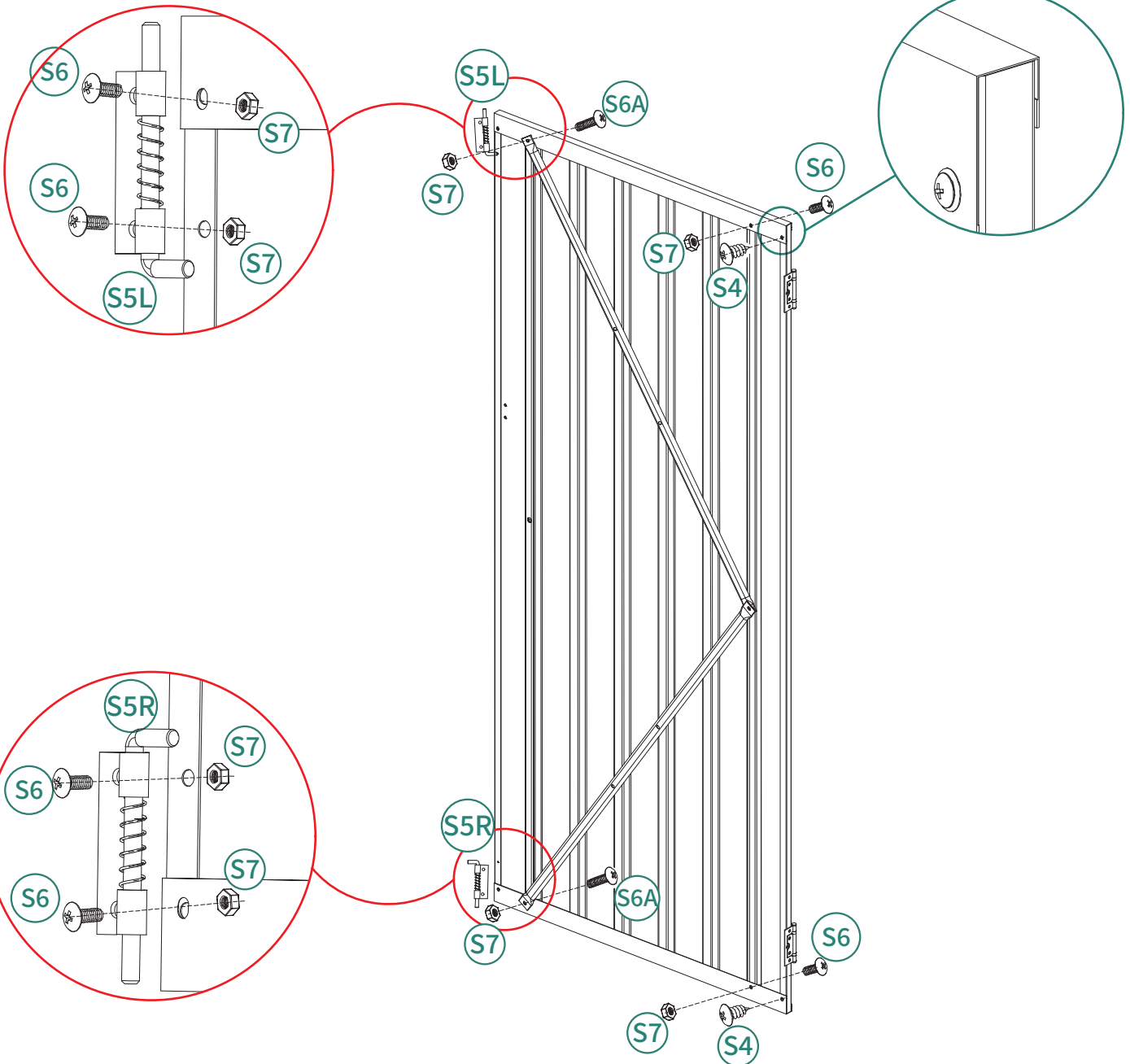

23

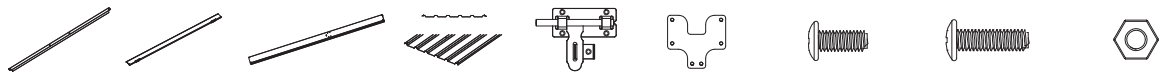
- 
- ⑮ 2pcs ⑯ 1pc ⑰ 1pc M1 1pc ⑳ 1pc ㉑ 1pc ㉒ 7pcs ㉓ 3pcs ㉔ 4pcs

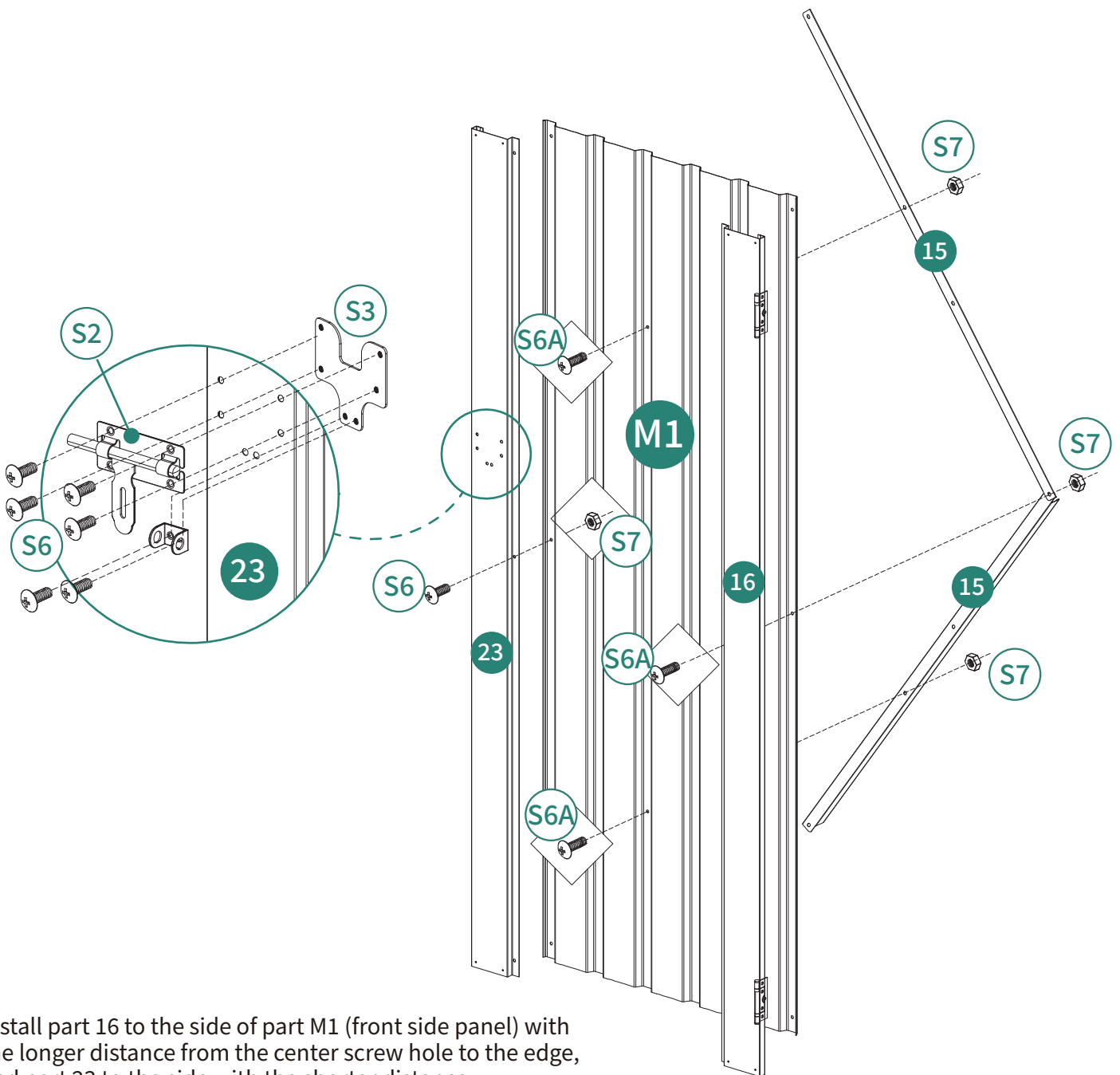

Install part 16 to the side of part M1 (front side panel) with the longer distance from the center screw hole to the edge, and part 23 to the side with the shorter distance.

24



(21) 2 pcs

(S4) 8 pcs

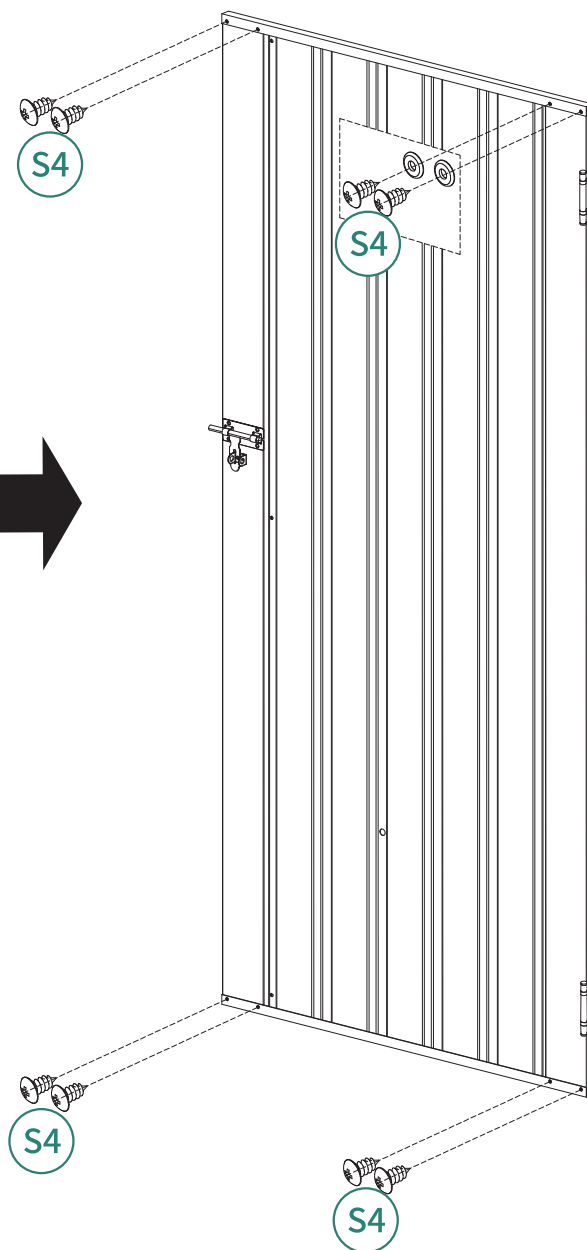
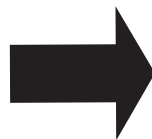
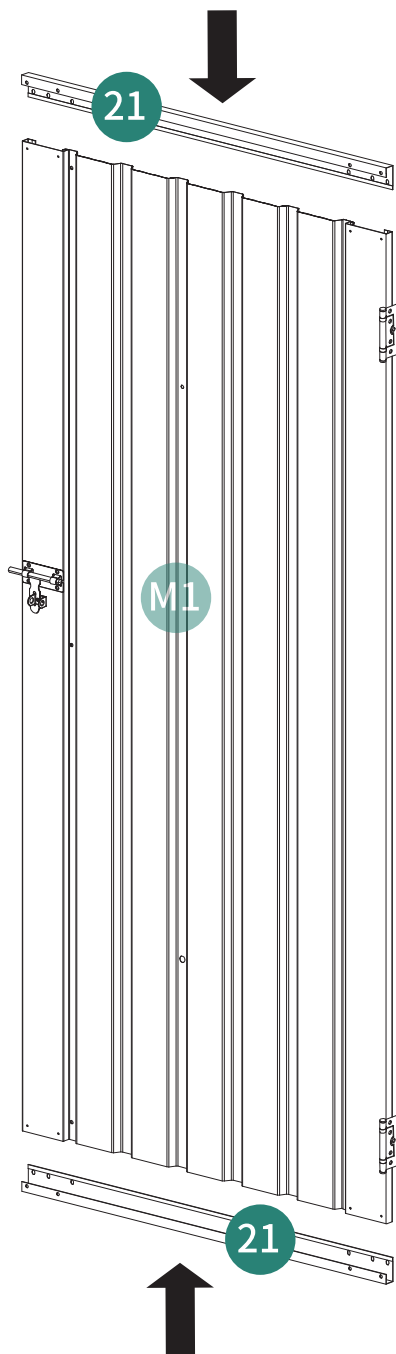

25



S4 4pcs

S6 2pcs

S6A 2pcs

S7 4pcs

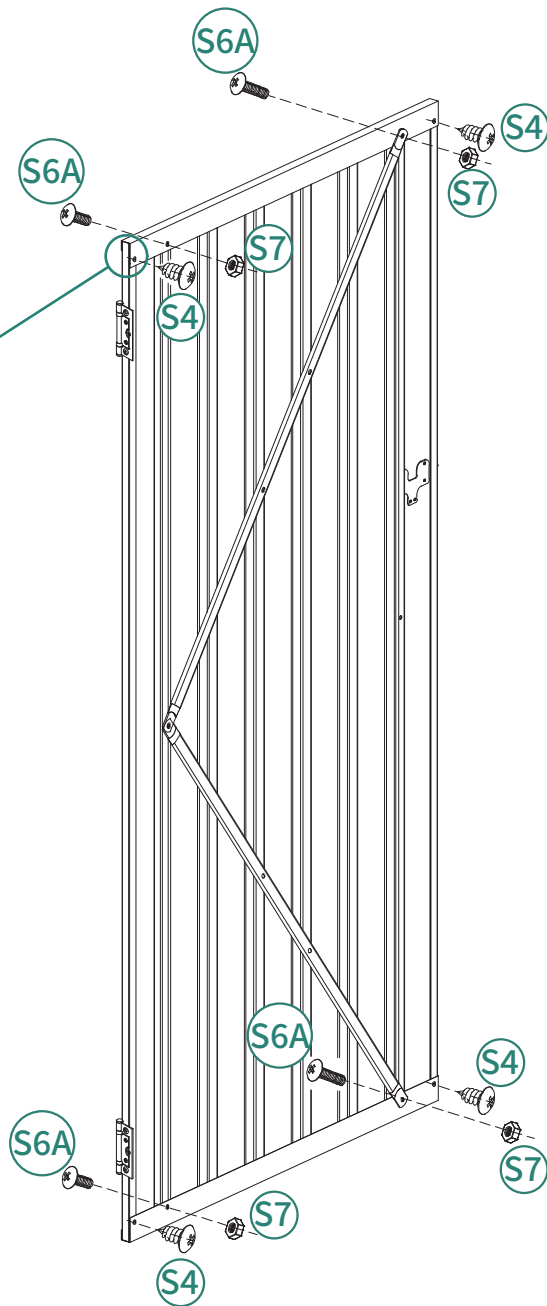
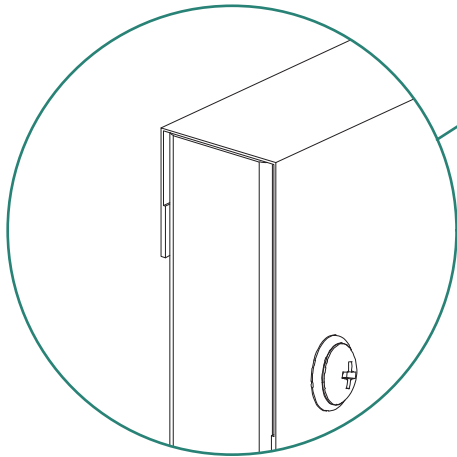

26



(S6) 12pcs (S7) 12pcs

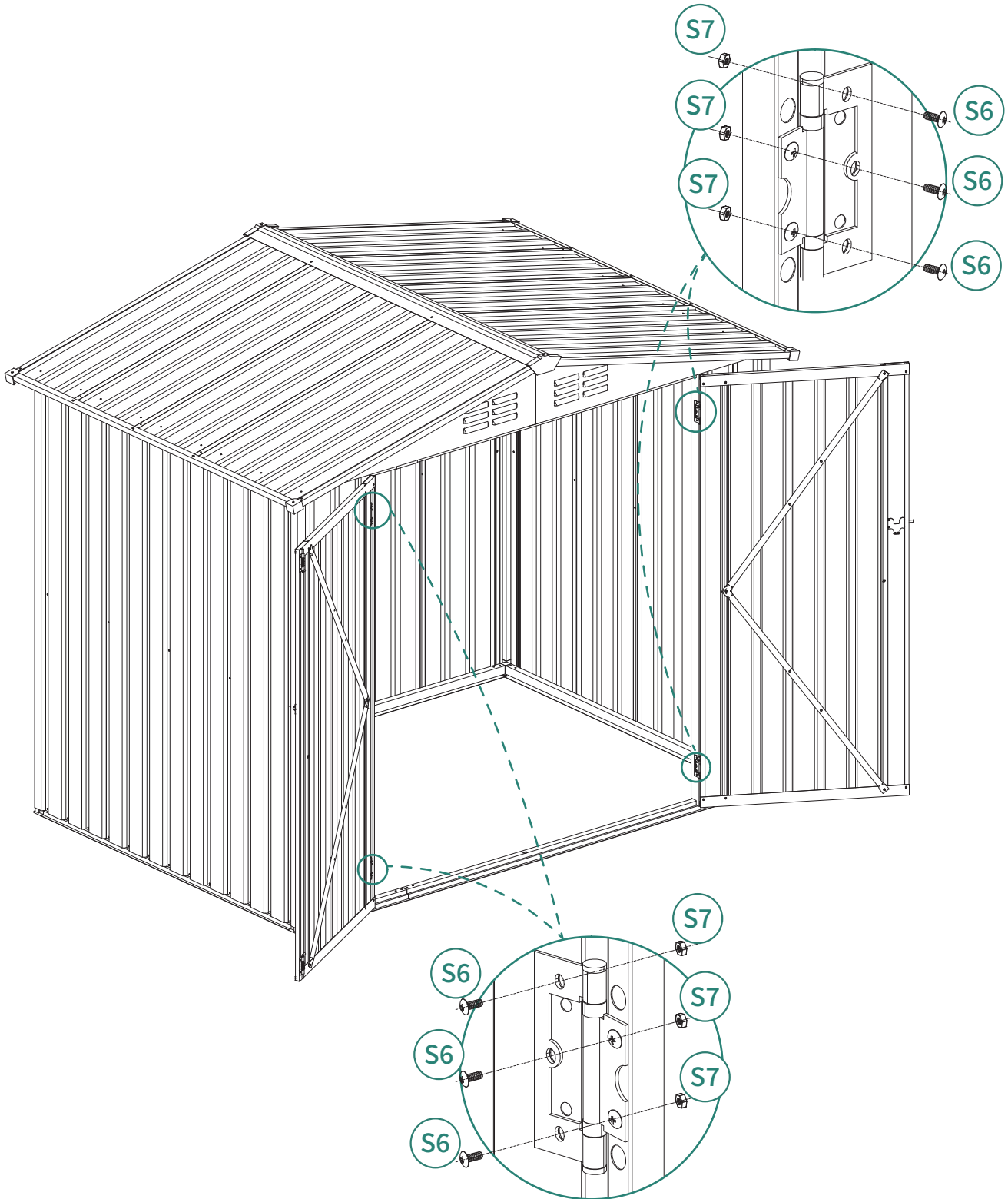

27



S9 4pcs

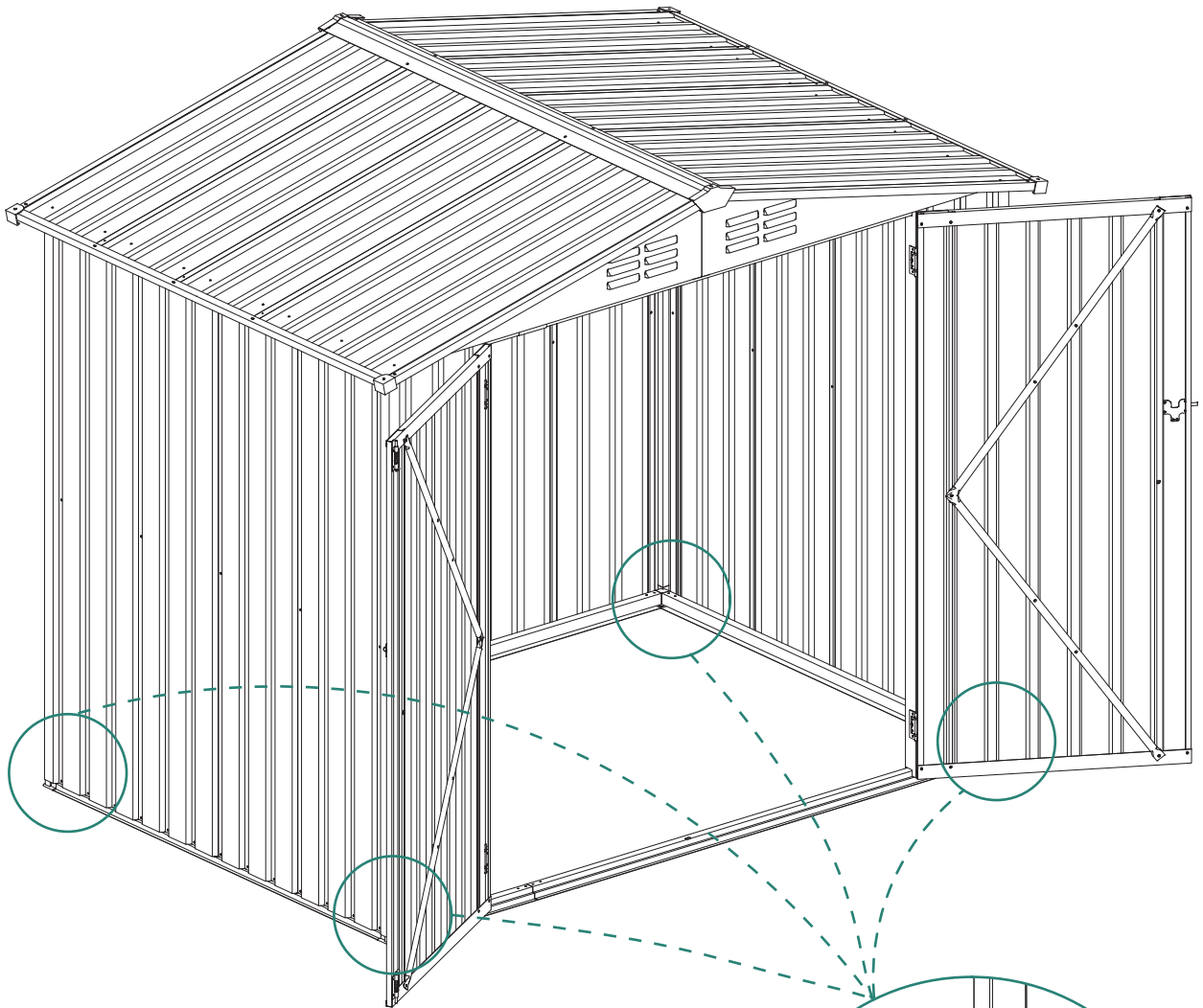

To improve the wind resistance, please be sure to complete this installation step. If expansion bolts or ground stakes are not installed, strong winds may cause the tool shed to collapse. Expansion bolts are crucial for the stability on concrete surfaces, and ground stakes are used for grassy areas. The accessory package includes the ground stake components, but the expansion bolts are not included.

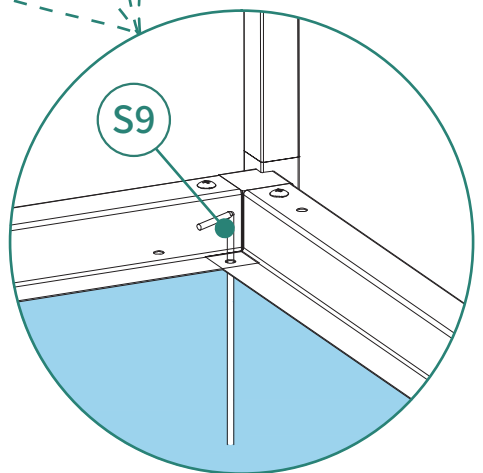

28

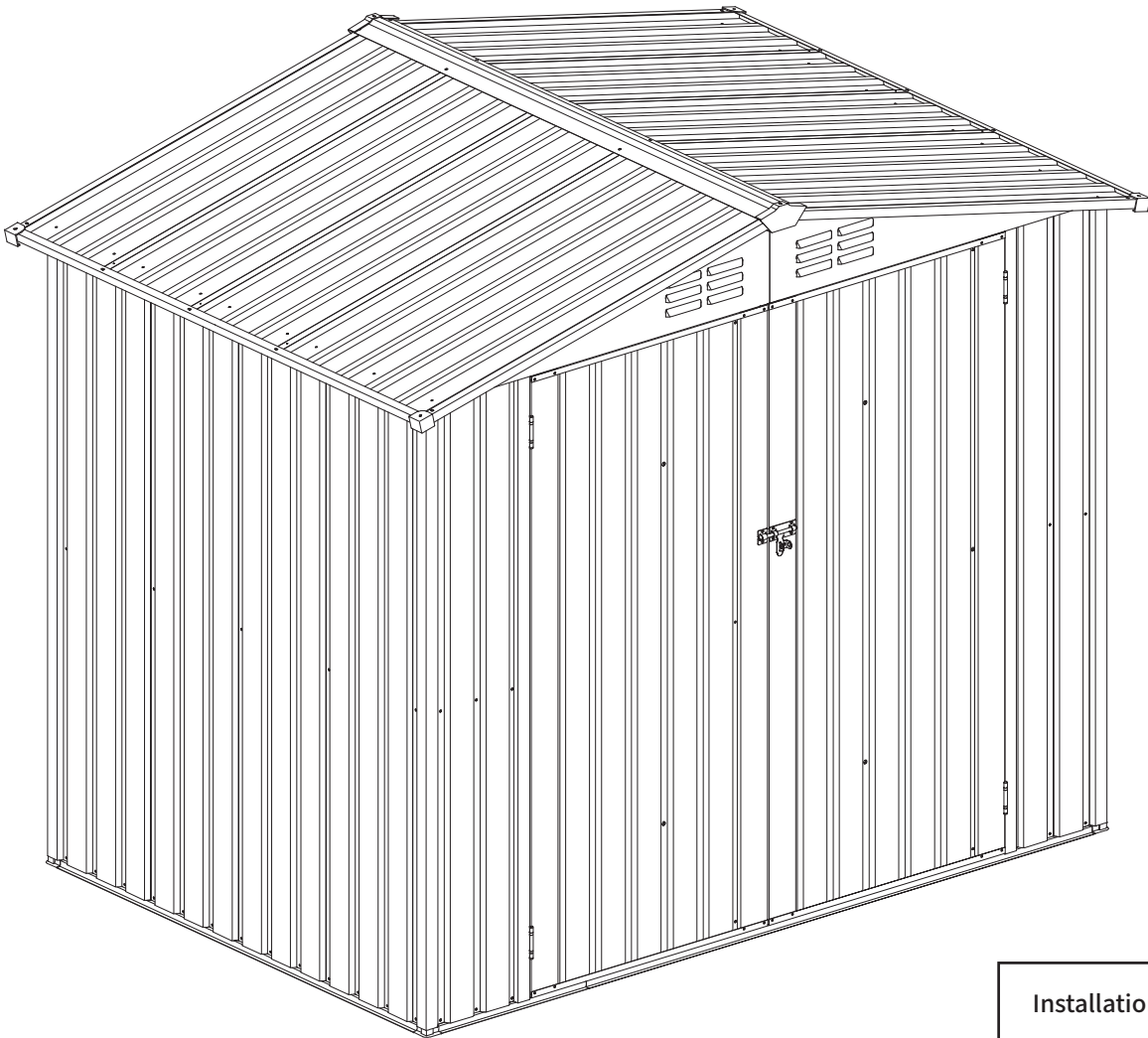

Installation Completed

Installation Abgeschlossen

Installation Complétée

Installazione Completata

Instalación Completada

HELP CENTER



Inquiry



Assembly issue



Missing parts

If you encounter any difficulties during assembly, please contact us.

Wenn Sie während der Montage auf Schwierigkeiten stoßen, kontaktieren Sie uns bitte.

Si vous rencontrez des difficultés lors du montage, veuillez nous contacter.

Se incontri difficoltà durante il montaggio, ti preghiamo di contattarci.

Si encuentras alguna dificultad durante el ensamblaje, por favor contáctanos.

DISCLAIMER

Manufacturer and seller expressly disclaim any and all liability for personal injury, property damage or loss, whether direct, indirect, or incidental, resulting from the incorrect attachment, improper use, inadequate maintenance, unapproved modification, or neglect of this product.

Der Hersteller und Verkäufer lehnen ausdrücklich jegliche Haftung für Personenschäden, Sachschäden oder Verluste ab, egal ob direkt, indirekt oder zufällig, die durch falsche Anbringung, unsachgemäßen Gebrauch, unzureichende Wartung, nicht genehmigte Änderungen oder Vernachlässigung dieses Produkts entstehen.

El fabricante y vendedor renuncian expresamente a toda responsabilidad por lesiones personales, daños materiales o pérdidas, ya sean directos, indirectos o incidentales, derivados de la incorrecta colocación, uso inadecuado, mantenimiento insuficiente, modificación no aprobada o negligencia de este producto.

Il produttore e il venditore declinano espressamente ogni responsabilità per lesioni personali, danni materiali o perdite, dirette, indirette o incidentali, derivanti dall'errato fissaggio, uso improprio, manutenzione inadeguata, modifica non autorizzata o negligenza di questo prodotto. Le fabricant et le vendeur déclinent expressément toute responsabilité en cas de blessures corporelles, de dommages matériels ou de pertes, qu'ils soient directs, indirects ou accessoires, résultant de la fixation incorrecte, de l'utilisation inappropriée, de l'entretien insuffisant, de la modification non approuvée ou de la négligence de ce produit.