

CARE AND MAINTENANCE

Unplug lamps before using any cleaning solutions. Dust shades with a feather duster or with an appropriate vacuum-brush attachment . Wipe with a soft, dry cloth and clean lamp bases with the methods appropriate to the material. Avoid the use of chemicals and household cleaners as they may damage the finish.

NOTICE&IMPORTANT SAFETY INSTRUCTIONS

- *Please make sure that you have all parts indicated before you begin assembly of this item.
- *This item should be assembled on a soft surface to prevent scratching the finish during assembly.
- *To reduce the risk of fire, electrical shock or injury to persons or property, please follow the guideline below for safe use and installation.
- *The external flexible cable or cord of this luminaire can not be replaced; if the cord is damaged, the luminaire shall be destroyed.







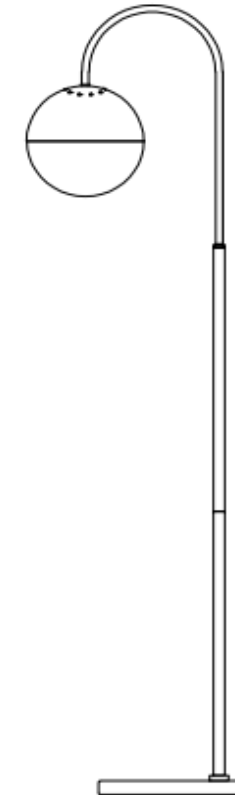

**This portable lamp has a polarized plug (one blade is wider than the other) as a safety feature to reduce the risk of electric shock. This plug will fit in a polarized outlet only one way. If the plug does not fit fully in the outlet, reverse the plug. If it still does not fit, contact a qualified electrician. Never use with an extension cord unless the plug can be fully inserted. Do not attempt to defeat this safety feature.



Product Dimensions:

15.25" LX 9.8" WX 55.5" H



Part List and Hardware List

PIECE	DESCRIPTION	PICTURE	QUANTITY	PIECE	DESCRIPTION	PICTURE	QUANTITY
A	metal shade		1X	G	Socket		1X
B,C	Tube		1X	H	triangle clip		1X
D	Base		1X	I	bulb		1X
E	spanner		1X	J	acrylic shade		1X

F	non woven		1X	k	cord and switch		1X
---	-----------	--	----	---	-----------------	--	----

PREPARATION

Before beginning assembly of product, make sure all parts are present. Compare parts with package contents list and hardware contents list. If any part is missing or damaged, do not attempt to assemble the product.

Estimated Assembly Time: 12 minutes.

**PLEASE USE ON/OFF TYPE "A" BULB MAX 25-WATT OR CFL BULB MAX 9-WATT
THERE ARE 1PCS CFL 9-WATT BULB IN THE BOX.**

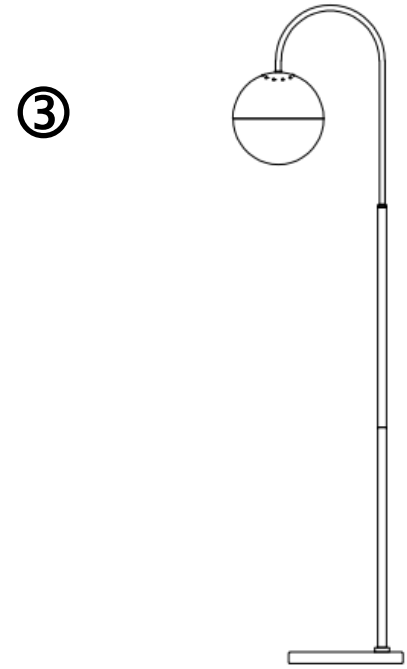
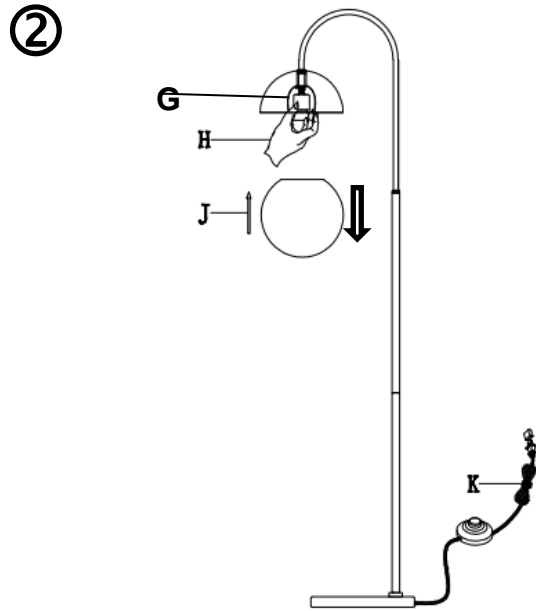
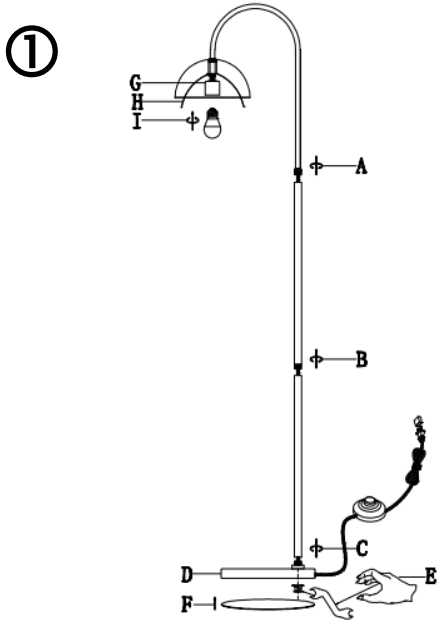

Step 1

Insert the tube (C) into (B) and (A) in order. Gently pull the cord so that the body (A, B, C) comes into contact with the base (D)

Use the spanner (E) to screw the base. Stick the non woven (F) on the base bottom

Remark:

If you want to change the bulb, you need to hold the shade (J) and pull it down.

Step 2

Please hold the triangle clip (H) and insert the bulb (I) into the socket (G). Then put it into the acrylic shade (J).

Step 3

Put the lamp on a level surface to check if everything is stable.

ENJOY YOUR LAMP