

Guide Book



WARNING: Chocking Hazard! Contains small parts. Dispose of plastic bags properly.



WARNING: Adult assembly required. Contains sharp points, sharp edges and small parts. Please keep out of reach of children.



WARNING: Not to be used in traffic.



Please read this manual before giving this toy to your child. This manual contains important information, please keep it for later reference.

MADE IN CHINA

ASSEMBLY INSTRUCTION

About the products

Thank you for choosing our children's electric car. We are committed to providing exceptional quality and designing comfortable and safe ride-on cars for children. We aim to accompany every child's growth with our carriages. Before using the product, please carefully review this instruction manual as it provides detailed guidance on proper assembly and operation. To ensure the safety of your children and prevent any damage to the product, please follow the instructions diligently. Kindly keep this manual for future reference.

Specifications

Battery: 24V7AH*1

Applicable age: 3+ years old





Maximum load: 50KG (110 lbs)

Charge time : Charge 8-12 hours

Charger : 24V800mA

Speed: 5-9.5KM/h (3.1-5.9 mph)

Parts List

Part Number	Part Name	Picture	Q'ty (pcs)	Part Number	Part Name	Picture	Q'ty (pcs)
1	CAR BODY		1	2	FRONT AXLE (WITH TWO NUTS)		1
3	REAR AXLE (WITH TWO NUTS)		1	4	STEERING WHEEL		1

Part Number	Part Name	Picture	Q'ty (pcs)	Part Number	Part Name	Picture	Q'ty (pcs)
5	WINDSHIELD		1	6	WHEEL		4
7	FRONT WHEEL MOTOR (L/R)		1	8	SEAT		2
9	REAR WHEEL MOTOR (L/R)		1	10	SIDE TAIL FRAME		2
11	REAR TAIL FRAME		1	12	REARVIEW MIRROR (L/R)		1
13	DRIVEN CONNECTOR		4	14	WHEEL CAP		4
15	PEDAL (L/R)		1	16	REAR MUDGUARD (L/R)		1
17	FRONT MUDGUARD (L/R)		1	18	SHOVEL		1
19	FRONT BUMPER		1	20	FRONT BUMPER TRIM		1
21	WRENCH TOOL		2	22	CHARGER		1
23	REMOTE CONTROL		1	24	M4*12mm Flat head screw		18
25	M4*12mm Round head screw		12	26	M4*14mm screw		4
27	Washer		4				

Analytic graph

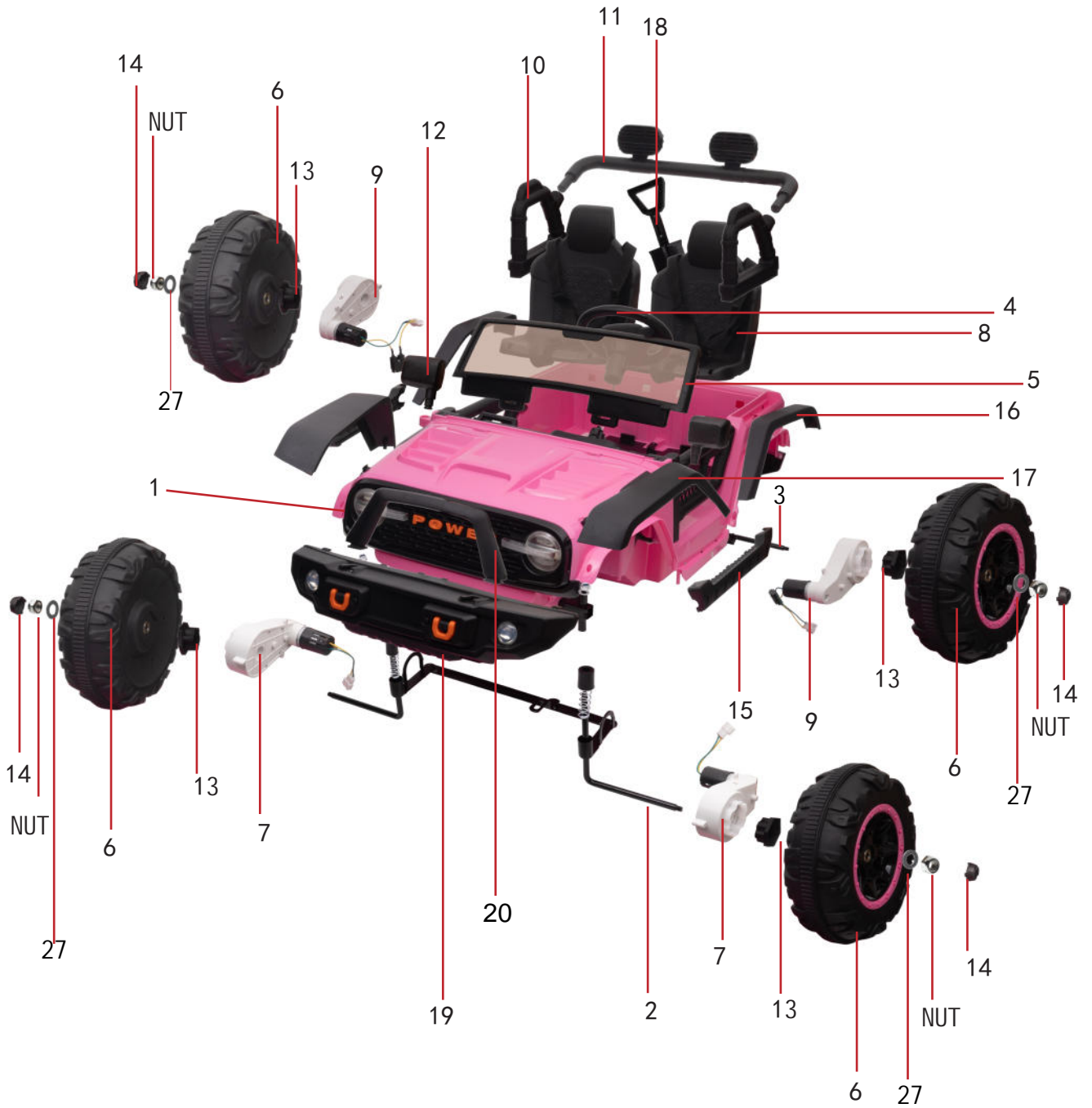

Assembling

- The vehicle should be assembled by an adult before use. It will take 30 minutes to complete.
- The small parts might cause choking, please keep them away from the children.
- Please check the number of the parts before assembling, and keep the packaging bags away from the children in case of choke.

Installation Order Diagram

1. Installation of pedals and mudguards

1. Fix the front and rear mudguards with M4*12mm flat head screws (8pcs) according to (16,17) numbers corresponding to the body numbers.
2. Snap the left and right pedals (15 L and R correspond to the body) into the body slots and secure them with M4*12mm flat head screws (6pcs) .



2. Installation of front bumper

Push the front bumper in against the front of the car, secure it with M4 *14mm screws (4pcs) , put the light wires into the front compartment, open the bonnet, connect the light wires.

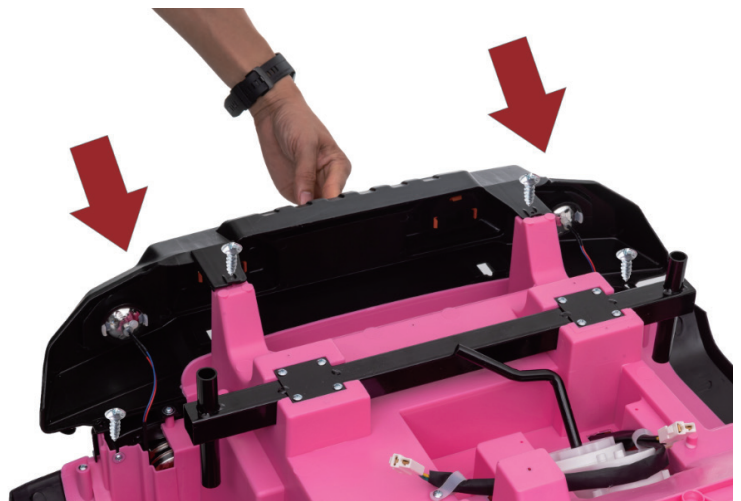

3. Installation of front wheel

1. Rotate the steering shaft to face upwards.

2. Remove the nuts(2pcs) and washers(2pcs) from the front axle shock absorber and set aside, adjust the direction of the steering rod to fit the front axle into the steering rod, and finally fix it with the washers(2pcs) and nuts(2pcs). Tighten the nut with wrench tool.

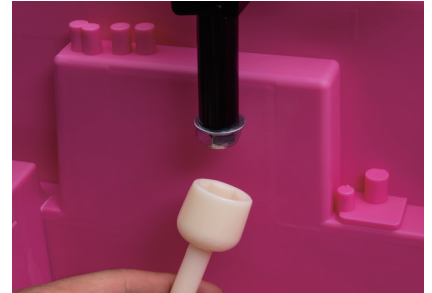

3. Remove the nuts (2pcs) on both sides of the front axle and spare them, put the front drive motors on both sides of the front axle (L and R correspond to the body), and connect the motor wires with the connecting wires under the car.

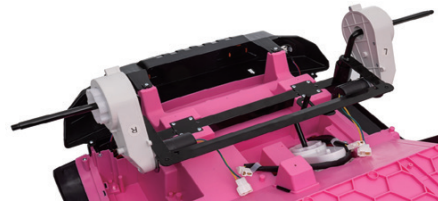

4. Fix the drive connector on the wheel with M4*12mm round head screws(3pcs), then put the wheel on the front axle, install the washer and fix it with a nut. Tighten the nut with wrench tool.
5. Finally press on the wheel cover.

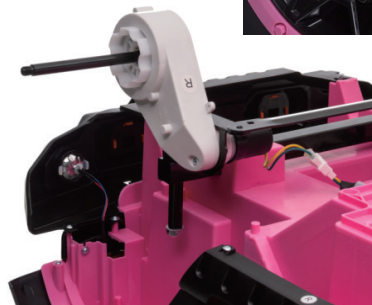

4.Installation of rear wheel

1.Remove the screw(2pcs) from the rear wheel shock member of the body for spare, place the rear frame support tube into the shock member slot and finally secure it with the screws(2pcs).

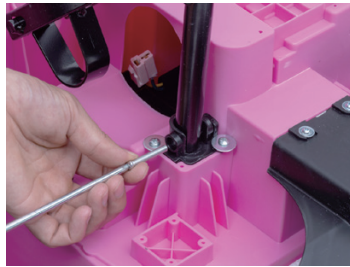

2.Remove the nuts (2pcs) on both sides of the rear axle and spare them,thread the rear axle through the frame.
Put the rear drive motors on both sides of the rear axle (L and R correspond to the body)



3.Fix the drive connector on the wheel with M4*12mm round head screws(3pcs), then put the wheel on the rear axle, install the washer and fix it with a nut.Tighten the nut with two wrench tools.
4.Finally press on the wheel cover.



5. Installation of seat and Connect the motor wiring and power cord

1. Remove the screws on the seat cover and remove the cover.
2. Plug the connectors of the left and right drive motors into the designated terminals on the circuit board. Insert the connector from the battery into the designated terminal on the circuit board. Finally put on the cover and fix it with screws.

NOTE: Make sure the connector is oriented correctly to fit into the terminal.

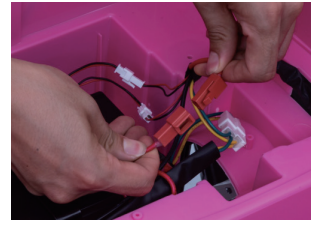
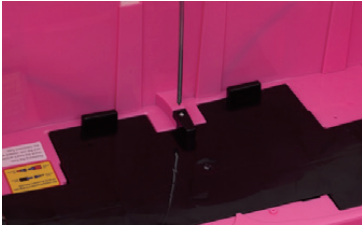

3. Snap the two seat rear side snap hooks into the body slots and secure with M4*12mm flat head screws(4pcs).

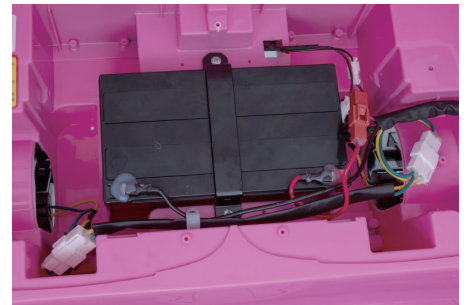

6. Installation of steering wheel

Match the steering wheel connecting wires to the body connecting wires, then snap the steering wheel into place to secure it.



7. Installation of windshield and rearview mirror

Align the windshield and rearview mirror for insertion.



8. Installation of rear and side tail frame

Snap the left and right side tail frame into the body (with the rear tail frame attachment ports facing backwards), remove the screws and nuts(2pcs) from the side tail frame, insert the rear tail frame into the side tail frame, and secure them with the screws and nuts(2pcs).



9. Install front bumper trim and shovel

Insert the front bumper trim into the front bumper.
Insert the shovel to the rear of the car.



Function

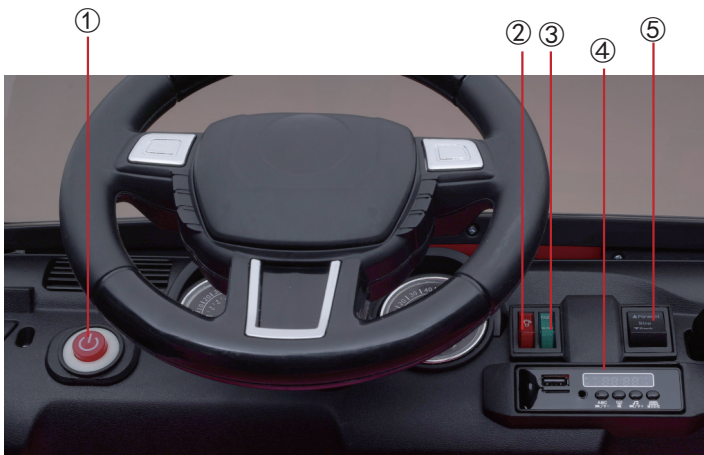

Button function

- ① Start button
- ② Light button
- ③ Speed button
- ④ MP3 Player
- ⑤ Forward
Stop it
Back



charging port

foot pedal

Front wheel motor cut-off switch: Press the switch to "0" the front wheel motor is disconnected and the front wheel can be rolled. Press "1" to connect the front wheel motor.

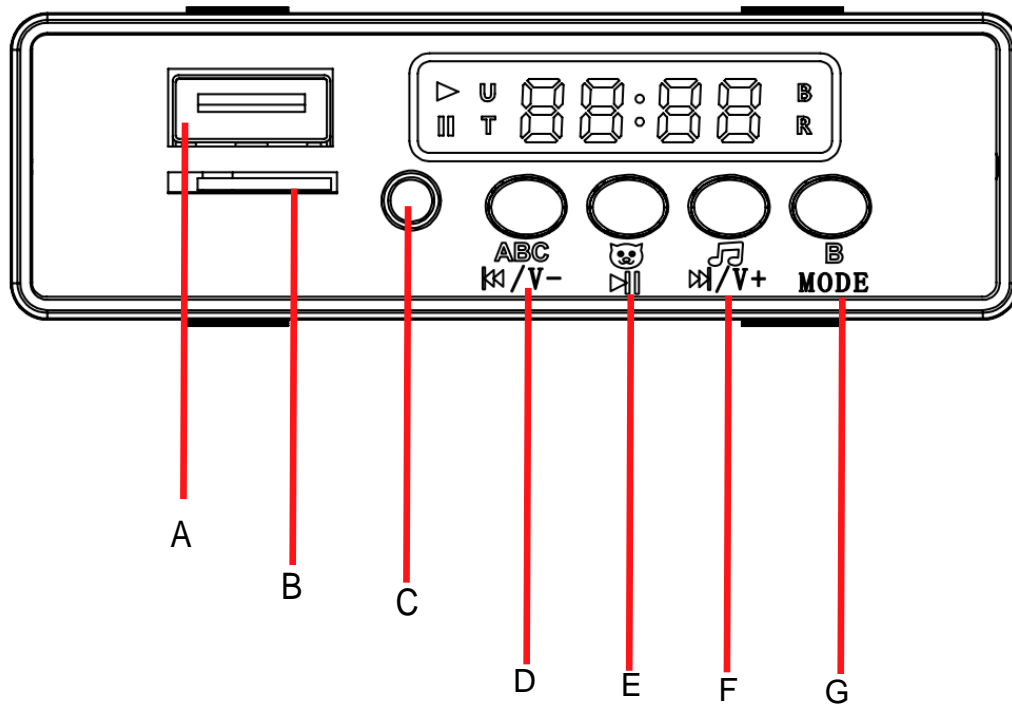

- A: USB port
- B: SD port
- C: MP3 AUX
- D: Music/ Previous song/ press long time with volume reduction
- E: stop music
- F: Next song / press long time with volume increase
- G: Wireless connection

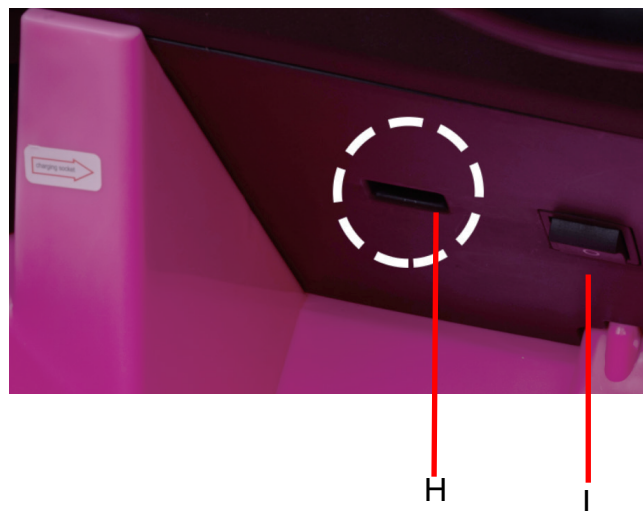

- H: charging port
- I: 2 motors/ 4 motors toggle switch

Remote Control Function and Instructions

- Do not swift forward/backward button when car is driving, or will damage the motor.
- Remote control can be used normally when battery assembled.
- Remote control should be used under adults supervision.
- Remote control is prior to man control.

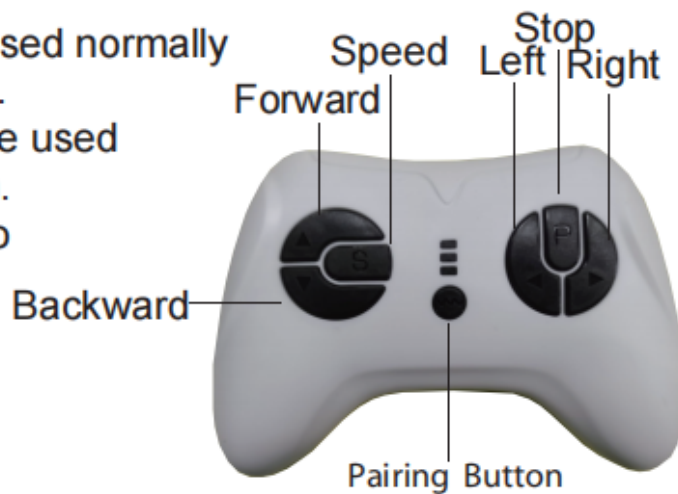

How to adjust R/C frequency.

Long press forward and backward

button for 3 seconds, and the speed indicator flashes. Then turn on the power, the speed indicator goes to long bright, means the connection successfully. If the speed indicator no response, means the connection failed. Replace the batteries and retry.

Charging steps are as follows:

Step 1 : The charging port is under the steering wheel.

Step2: Put the charger plug into the plug port.

Step 3: Connect the charger to the power socket.

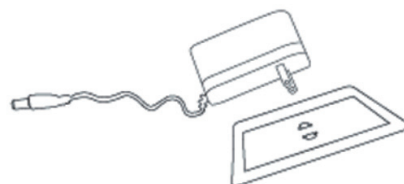

**Warning: Car must be charged by adults only.
The car cannot be used while it's charging**

Safety use

- Never use on roadways, near motor vehicles, on or near steep inclines or steps, swimming pools or other bodies of water.
- Use the toy only on flat surfaces. Do not play in streets, roads, slopes or ditches.
- Never use in muddy or sandy areas. The toy is made to operate on dry leveled ground.
- Never use in the dark or in dimly lit areas.
- Play the car in the dry area, not wet. Keep away from fire, or may damage the line.
- Do not change the line or add electric device to the car.
- Clean the toy with a damp cloth and never submerge the toy in water or spray with water directly from a hose.
- One rider one time only. Do not overload. Maximum capacity is 50KG (110 lbs).
- Turn power off if not in use. If it has not been used for a month, unplug battery line.
- Check battery, charger and other parts regularly.
- If any problem, please fix it before playing.

Charging notification

- For the first use, please charge 8-12 hours, or will damage the battery.
- Plug charger DC line into charge port first, then plug charger into socket.
- Do not use the car when it is charging.
- Do not charge the battery more than 20 hours each time. It is normal that charger and battery warm (under 140°F) during charging.
- Do not charge if plug is wet, or will occur short-circuited.
- Only use charger provided by manufacturer, or will damage charger and battery or occur short-circuited.
- Please charge the car at least once a month.

Maintenance and Service

- Check battery, charger and other parts regularly. If there is any problem, or excessive wear or damage detected, do not use the toy, the charger or the battery until you have fixed the damaged or worn part.
- Use lubricating oil to care iron parts. Keep car away from fire and avoid long-time direct sunlight. Park it on the even place, do not reversal or gradient.
- Park it indoor and cover it with waterproof cloth.
- Keep car away from fire, stove or heater and direct sunlight, or plastic may melt.
- Keep away from flammable things, or may occur fire accident.
- Charge it after use and must be done by adults only.
- Please charge it at least once a month in order to maintain battery.
- Clean the vehicle with a dry cloth only. Do not use chemical solvent to wipe plastic parts.
- Do not wash it with water or use it when raining or snowing. Water will damage motor, electric system or battery.
- Please turn power off after each use.
- Only use charger provided by manufacturer.
- Please do not alter the structure of the cars or electrical lines. Prior to undertaking any job, ensure that you possess the required skills or seek guidance from a specialist.

Remote control battery operation

- Take off the battery cover. Put two AAA1.5V remote control battery in with right polarity (Battery not included) .
- New and used batteries can not be used mixed.
- Do not insert batteries into wrong polarity, or will be short-circuited.
- Non-rechargeable batteries can not be recharged. Exhausted batteries should be replaced by adults.
- The exhausted battery must be handled and operated properly by adults only.
- Do not allow children to play with the battery.