

A305 MASSAGE CHAIR

Operation Instructions

SAVE THESE INSTRUCTIONS

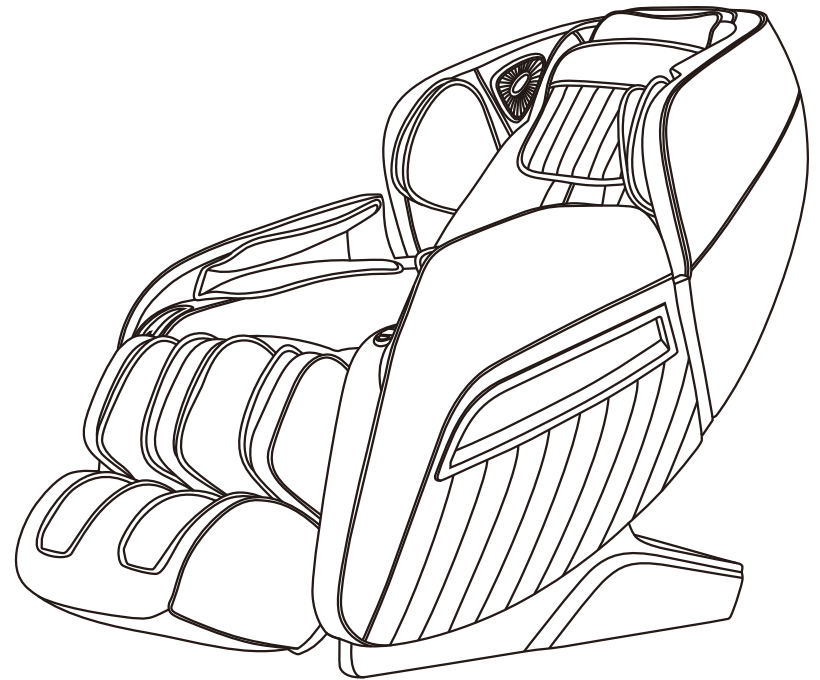

Thanks for purchasing this product. Please read this manual instruction carefully in order to know how to use this product correctly before operation. Please pay more attention to some important safety warning and keep this manual book properly for future use.

Note: Our Company reserves the right to revise the design and description of this product without any further notice. Please refer to the actual color of this product.

CONTENTS

Safety and maintenance	02
Safety warning	04
Name and function of components	06
Function	07
Method of usage	08
Product specification	20

Safety and maintenance

1. Important Safety Warning.



- Don't allow children to touch moveable part of this product.
- Please use well-grounding power supply suited to this product.
- Please pull out the plug after use or before cleaning to avoid injury or Damage to the product.
- Please operate this product according to this manual instruction.
- Don't use accessories which are not recommended.
- Don't use this product outdoors.
- Please read this manual instruction carefully before operation.
- Any other usage that is not listed in this manual instruction is forbidden.
- 20 minutes of usage each time is recommended.
- Please don't use it if the leather is broken or damaged.
- Please don't use it if the cover or leather is damaged.
- Please don't use it if the radiator hole is covered or blocked.
- Please don't drop anything into this product.
- Please don't fall asleep while using this product.
- Please don't use it if drunk or feel unwell.
- Please don't use it within one hour after having meal.
- Please don't make the massage function too strong for avoiding Injury.
- Please do not carry fragile, explosive and combustible materials in your pocket such as mobile phones, lighters and so on, when using massage chair.

2. Environment for usage.

- Please don't use it under high temperature and moist environment such as bathroom.
- Please don't use it immediately while the environmental temperature changes sharply.
- Please don't use it under heavy-dusty or caustic environment.
- Please don't use it where there is not enough space or not good ventilation.

3. People who are not suitable to use this product.

- People who are suffering from osteoporosis are not suitable to use this product.
- People who are suffering from heart disease or carrying electronic medical equipment such as heart pacemaker are not suitable to use this product.
- People who are suffering from fever are not suitable to use this product.
- Pregnant women or women that are in menses period are not suitable to use this product.
- People who got injured or skin disease are not suitable to use this product.
- Children under 14-year old or people mentally unbalanced without being Supervised are not allowed to use this machine.
- People who are told by doctor to have rest or people who feel unwell are not suitable to use this product.
- People whose bodies are wet are forbidden to use this product.
- The appliance has a heated surface. Persons insensitive to heat must be careful when using the appliance.

4. Safety.

- Check the voltage if it is suitable to the specification of this product.
- Don't use wet hand to pull the plug.

Safety and maintenance

- Don't make water go inside this product to avoid electric shock or cause damage to this product.
- Don't damage the wires or change the circuit of this product.
- Don't use wet cloth to clean the electric parts such as switch and plug.
- Be away from this product under power cut state to avoid injury if the power comeback suddenly.
- Stop using this product while it works abnormal, and please consult local agent immediately.
- Stop using this product if you feel unwell, and please consult health care doctor.
- This appliance is not intended for use by persons (including children) with reduced physical, sensory or mental capabilities, or lack of experience and knowledge, unless they have been given supervision or instruction concerning use of the appliance by a person responsible for their safety.
- Children should be supervised to ensure that they do not play with the appliance.
- If the supply cord is damaged, it must be replaced by the manufacturer, its Service agent or similarly qualified persons in order to avoid a hazard.

5. Maintenance.

- This product should be maintained by certain appointed agents, users are prohibited to disassemble or maintain by themselves.
- Please don't forget to cut the power after usage.
- Don't use this product if the socket looses.
- If this product will be left unused for long, please curl up the wires and reserve this product in dry and dustless environment.
- Don't reserve this product under high temperature or near fire and avoid longtime direct sunshine.
- If the detachable cord / supply cord is damaged, it must be replaced by the manufacturer, its service agent or similarly qualified persons in order to avoid a Hazard.
- Please clean this product by dry cloth. Don't use thinner, benzene or alcohol.
- The mechanical components of this product are specially designed and made, it is not necessary to be specially maintained.
- Don't use edged res to thrust this product.
- Don't roll or pull this product above uneven ground, it should be lifted before moving.
- Please use it intermittently; don't make this product work continuously for long.

6. Solution of ordinary malfunctions.

- It is nature movement voice if the motor sounds while in usage.
- If the controller can't work normally, please check the plug and socket if they are connected strongly and make sure the switch is turned on.
- If the rated working time is over, the product will automatically activate the power-off button; If this product works continuously for long, the temperature protector will make the product automatically power-off, it should be used again after half an hour's rest.

Safety warning

⚠ Warning

When the footrest lifting, people should not apply pressure on the footrest to avoid the massage chair falling forward to damage the product or cause personal injuries.

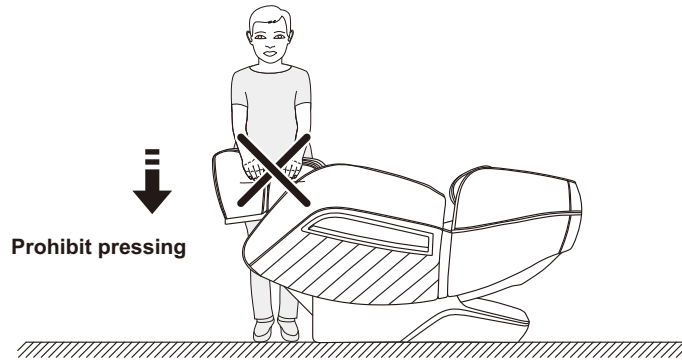

⚠ Warning

Before sitting on the massage chair, make sure that the massage hand stays in the seat cushion position to avoid discomfort to the buttocks during the body pressing down and damage to the massage hand.

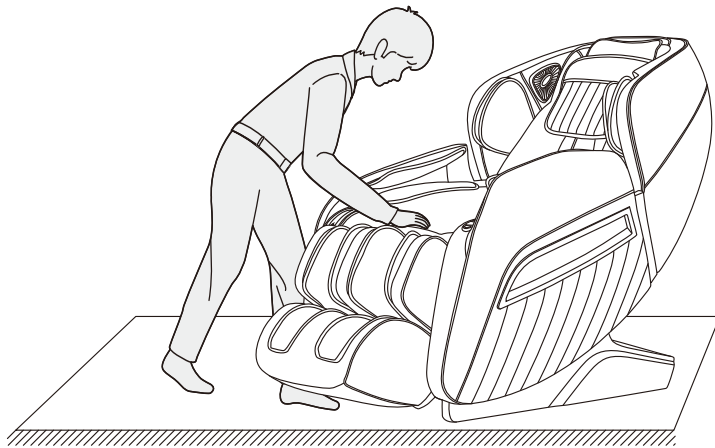

Safety warning

⚠ Warning

Do not strive to pull out the control cable or power cord during standby or power-on state to avoid product damaged or electrocution accidents. Advise you unplug the controller cable and power cord and put away after you use the chair.

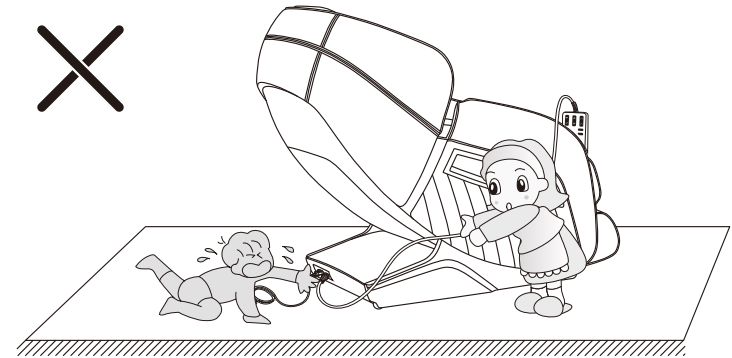

⚠ Warning

When start the zero gravity lying function, be sure to check whether there are children and pets under the bottom of the footrest and backrest, may cause the product damaged or personal injuries.

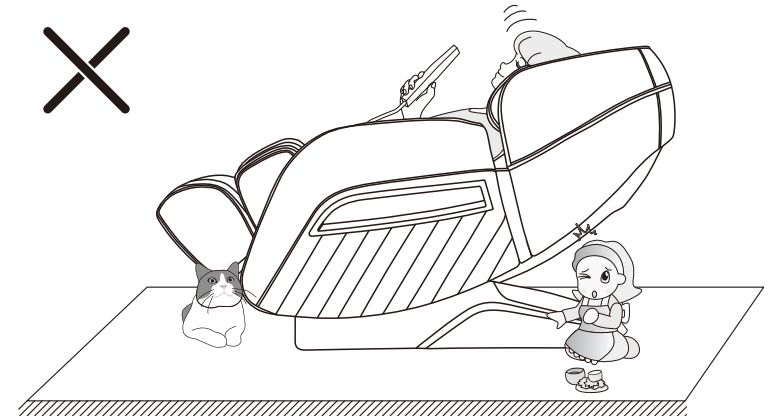

Name and function of components

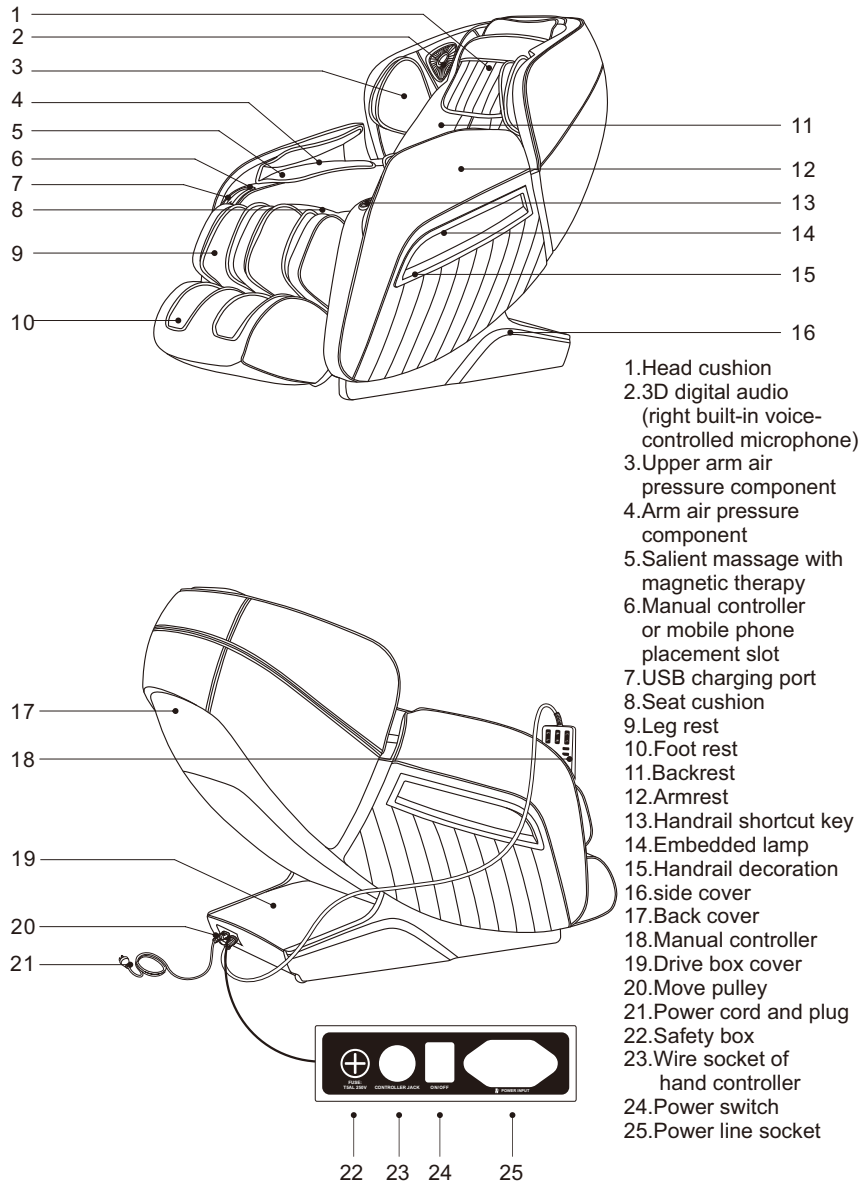

Function

- This product has designed a set of massage manipulator that can walk up and down, four-wheel drive and mute design.
- There are five simulative massage techniques: finger pressing, kneading, tapping, tapping and kneading at same time.
- Equipped with shoulder automatic positioning detection.
- Automatic massage functions: automatic massage includes 12 kinds of automatic massage functions, including comfortable massage, relaxing massage, traction massage, shoulder and neck massage, back and waist massage, whole body massage, Protection of vertebral massage, fatigue recovery, stretching muscles and activating collaterals, beautiful buttock shaping, soothing sleep and full air pressure.
- Equipped with upper body manual massage function (the whole body, fixed point and local three massage parts are selected, and the speed of each massage manipulation can be adjusted with five speed. In fixed point and local state, the manipulator can adjust the position up and down; When tapping, pressing and percussion massage, the width of the massage ball can be wide, medium or narrow.
- Pneumatic massage function three modes and three levels of intensity selection; Body pressure, arm pressure, leg pressure,.
- It is equipped with foot roller massage function.
- With leg frame with stepless adjustable function, suitable for different height use.
- With back heat treatment function: carbon fiber as far infrared heat source.
- Under the backrest frame, the backrest adopts slide rail technology to keep the zero space against the deviation wall all the time, so as to save the space to the greatest extent.
- Backrest frame guide adopts curve guide technology, which completely conforms to the curve of human back, and can enjoy massage from head to thigh.
- Music playback system, 3D digital audio built into left and right upper arms. Use the Bluetooth function of the smart device to play music wirelessly.
- Equipped with intelligent voice control recognition function.
- The left handrail is equipped with five kinds of handrail shortcut keys, such as open key, calf frame lifting key, automatic mode key, linkage adjusting key and zero gravity key.
- In the left and right palm air bags, there is a salient massage with a magnetic massage function.
- The right handrail is equipped with USB charging function.
- The handrails on both sides are equipped with ice blue atmosphere lamp
- LCD Color screen controller.
- Shutdown automatic sitting function, manipulator automatic reset function.

Method of usage

LCD: display all massage functions.

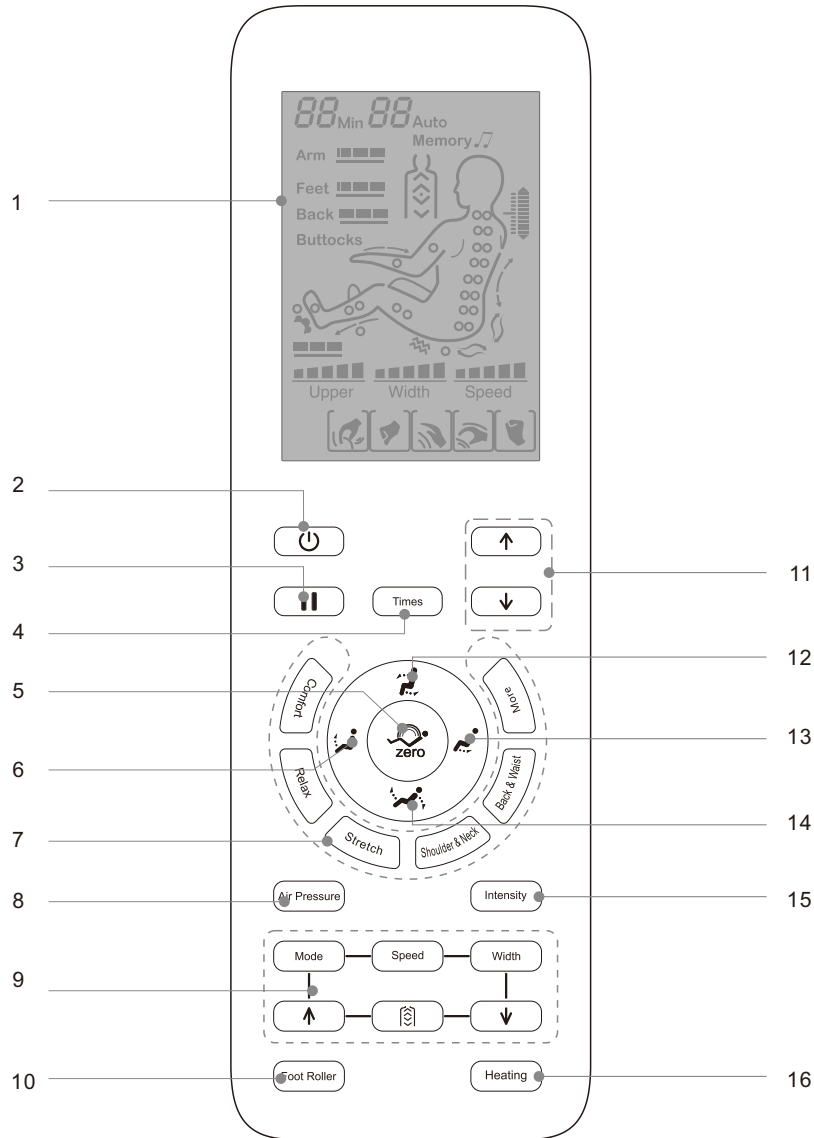

Method of usage

- 1.LCD:
 - Display all massage functions.
- 2.Power switch:
 - Turn on or off all massage functions.
- 3.Pause \ run button:
 - Pause or run all massage functions.
- 4.Timing key:
 - Timing time adjustment
- 5.Automatic reclining key:
 - There are three automatic reclining modes, which can automatically switch according to your own needs.
- 6.Footrest up key:
 - Adjust footrest up.
- 7.Automatic massage button:
 - Please refer to page 10 of this manual for details.
- 8.Air pressure mode key:
 - Turn on/off air pressure massage function (please refer to page 11 of this manual for details).
- 9.Manual massage key:
 - Please refer to page 11 of this manual for details.
- 10.Foot roller key:
 - Please refer to page 11 of this manual for details.
- 11.Shoulder adjustment key:
 - Manual adjustment of human shoulder position massage finger pressure point.
- 12.Up key:
 - Adjust backrest frame rise and calf frame drop.
- 13.Calf frame down key:
 - Adjust calf frame down.
- 14.Lie down key:
 - Adjust backrest frame to drop and crus frame to rise.
- 15.Air pressure intensity key:
 - Adjust air pressure intensity function.
- 16.Heating key:
 - On/off heating massage function.

Method of usage

1. Switch power supply on

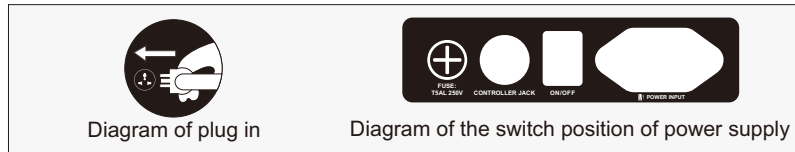

2. Start to massage

- ①、 Press the power button to start the massage.
- ②、 leg frame and back frame will automatically lie down Angle, waiting for the selection of massage function (select an automatic function), sitting posture adjustment more than 3 minutes without operation, automatic shutdown and sitting.
- ③、 After selecting the function of automatic mode, the automatic detection of human shoulder position and massage finger pressure point shall be carried out first, and wait for the completion of the detection.
- ④、 If the detected shoulder position is deviated from the actual shoulder position, adjust the upper and lower keys of the shoulder position to the appropriate position. The shoulder position has 10 positions. No shoulder position adjustment within 10 seconds, then automatically enter the massage function.

Button	Description	Display
	Move the massage balls upward to a suitable position	
	Move the massage balls downward to a suitable position	

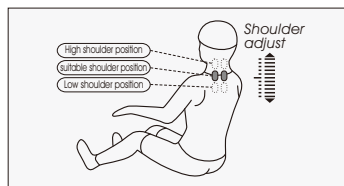

Place in a shoulder massage and acupressure point detection process, (manual device screen display shoulder position adjust icon and hear manual device "click" sound, and then key shoulder position which can adjust the position of shoulder), now has 12 can be automatically massage function keys (comfortable massage, massage, traction massage easily, massage neck, back, waist massage whole body massage, protecting vertebral massage, fatigue recovery, relaxes the muscles and stimulate blood circulation, shaping beautiful buttock, Ann god sleeps, full pressure) in any key and enter the massage function (skip step 5).

- ⑤、 Select the massage function, massage.











Method of usage

· Automatic massage







Function	Button	Description	Display
Automatic massage		Comfort: The most comfortable massage experience.	F1 Auto
		Easy: the depth of the soft and comfortable massage, relieve body fatigue	F2 Auto
		Frame and backrest frame rise and fall, and air pressure massage, and stretch or traction on the leg, remove fatigue, restore vitality.	F3 Auto
		Shoulder & neck: focus on shoulder and neck massage.	F4 Auto
		Back & waist: to back waist massage focus.	F5 Auto
		Full body massage: deep massage to rejuvenate the body.	A1 Auto
		chiropractic massage: focus on chiropractic massage, relax body and mind.	A2 Auto
		Fatigue recovery: improve the whole body fatigue pain, for the back, limbs to achieve relaxation and improve microcirculation, quickly relieve fatigue.	A3 Auto
		Meridians massage: dredge meridians, quickly improve the body's microcirculation, enhance immunity.	A4 Auto
		Beautiful buttock model: be aimed at buttock and thigh effective massage, beautify body shape, reduce the accumulation of redundant adipose body.	A5 Auto
		Sleep peacefully massage: through the twelve major health acupoints massage to help the body recuperate balance, quickly improve sleep, improve sleep quality.	A6 Auto
		All pressure:., focusing on the whole body pressure massage to fully relax the body, to the depth of the body massage, fully relieve fatigue and pain of the body.	A7 Auto

Method of usage

· Upper body manual massage

Function	Button	Massage ball adjustment	Display
Technique	Mode	Shiatsu: speed, width.	
		Knead: speed.	
		Beat: speed, width.	
		Knead pat: speed.	
		Knock: speed, width.	
Speed	Speed	5 speed adjustable.	
Width	Width	The width of the third gear can be adjusted.	
Back stretch	Back stretch	Fixed position and spot massage.	 H0
		Small area local round trip massage.	 H1
		A round trip massage.	 H2
	Up	Manipulator uplink	Massage position adjustment (in fixed point and local mode, massage position can be adjusted).
Down	Manipulator descending		

· Pneumatic massage

Function	Button	Description	Display
Air pressure Mode	Air Pressure	Full pressure: air pressure massage on arms, legs and feet.	Arm  Feet 
		Arm: air pressure massage with the arm as the focus.	Arm 
		Leg: barometric massage for leg, foot.	Feet 
Intensity	Intensity	Adjustable in three levels.	Arm  Feet 

· Foot roller massage

Function	Button	Description	Display
Foot roller	Foot Roller	Press this button to turn on or off the foot roller massage, and has a weak, medium, strong three levels of intensity can be adjusted to close the four states of cycle switching.	

Method of usage

· Heated massage

Function	Button	Description	Display
Heat	Heating	Press this button to turn on or off the back far infrared hyperthermia. Turn on 3 minutes later Have a warm.	

· Pause/start message button

Function	Button	Description	Display
Pause/start	Pause	Press this button in the process of massage, and all massage movements will be suspended the chair will turn off after 20 mins paused), and then press this key to resume all before suspension massage.	

· Adjust lying Angle

Function	Button	Description
Set up	Set up	Press this button, backrest frame slowly rise, calf frame slowly fall, and issued "di...di..."until it reached the top. Press this button again in the process of sitting, then stop sitting immediately.
Lay down key	Lay down key	Press this key, backrest frame slowly down, calf frame slowly up, and issued "di...di..."until it stops. Press this key again in lying down process, stop lying down immediately.
Calf Rise up	Calf Rise up	Press and hold this button, the calf frame slowly rises, and issue "di...Di..."Until it reaches the top and stops. Release it and stop adjusting.
Calf Go down	Calf Go down	Press this button, lower leg frame slowly, and issue "di...Di..." Until the end of the stop, release will stop adjustment.
Lie down automatically	Zero	Press the button every time to switch one automatic lying mode. There are three modes in total.

· Other manual functions

Function	Button	Description	Display
Timing	Times	Time adjustment, every time to press will add 5 minutes, can not exceed 30 minutes, if more than 30 minutes return to the minimum time value.	20min

Method of usage





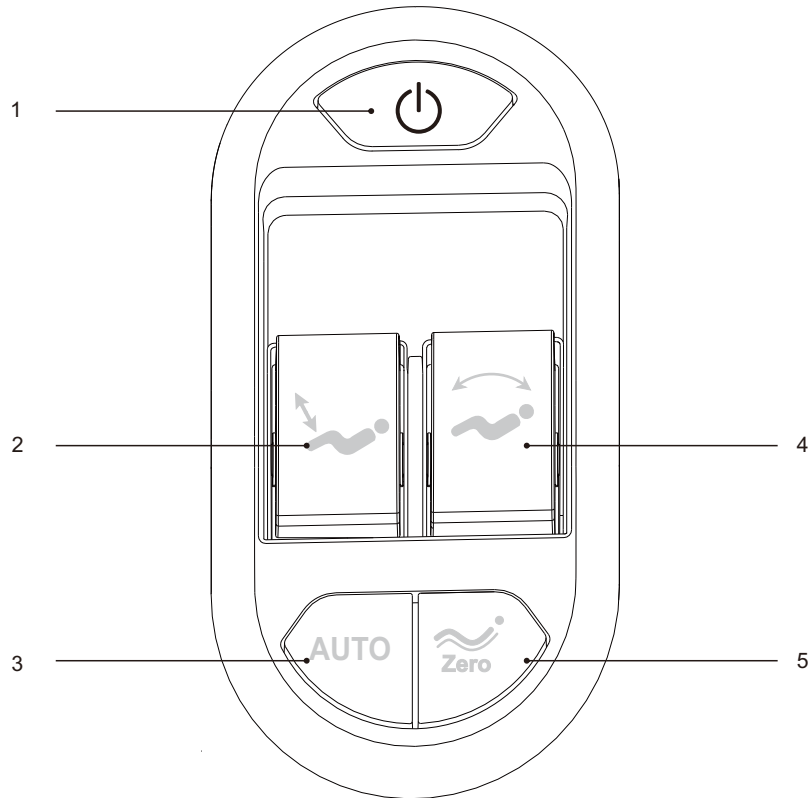

3.Introduction of handrail shortcut keys

The left arm



1. Turn on the key: open the massage chair.
2. calf lift key: adjust the calf up or down.
3. Automatic key: enable automatic massage function.
4. linkage adjustment key: linkage adjustment backrest frame lifting adjustment.
5. Zero-gravity key: adjust to the zero-gravity Angle of the massage chair.

Method of usage

Function	Description
	Power button: press this button to turn on or off all massage functions.
	Move the backrest and footrest up: Press the button, backrest up and footrest down slowly, it will stop once release the button.
	Move the backrest and footrest down: Lift up the button, backrest down and footrest up slowly, it will stop once release the button.
	Zero gravity key: every time you press the key, automatically adjust the position of calf frame and backrest frame to zero gravity position. There are three kinds of zero-gravity lying mode, which can be rotated.
	calf up key: lift the key up calf slowly, release will stop calf up.
	Calf frame down key: press the key down calf frame slowly down, release will stop calf frame down.
AUTO	Automatic mode key: press each time, automatic massage function switch.

Right arm

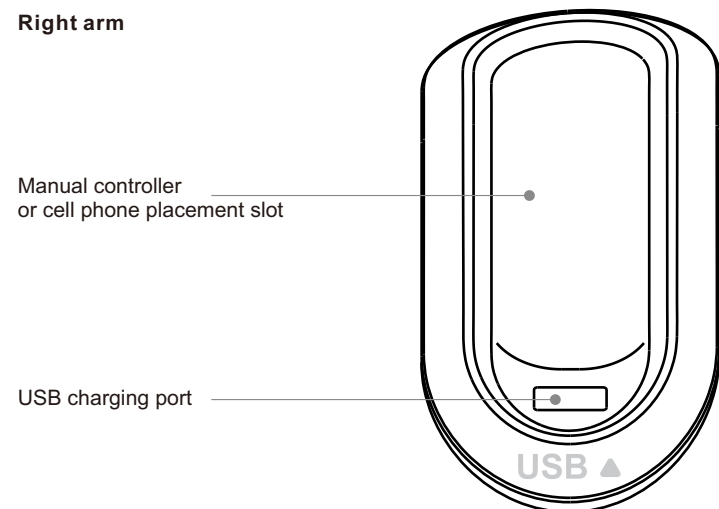

Method of usage

4.Voice control operation

- When the massage chair is turned on or in standby mode, say “Alice Alice” to wake up the voice control function.
- After the successful wake-up, the massage chair will reply “I am here”. At this time, the voice control entry corresponding to the function is realized within 6 seconds. After the massage chair is respond, the corresponding voice control function can be realized; if did not correctly say any voice entry for more than 6 seconds, the voice control function automatically turns off and needs to be reawakened.
- Note: When waking up the voice control function, please use Mandarin, the speech rate is moderate, Voice commands should be follow up the Voice entry.

Voice control enter		
Awakening words: “hi Alice”. Answer: I am here.		
Serial No	Voice control entry	Answer entry
1	Massage on	Answer: Ok, massage on.
2	Massage close	Answer: Ok, massage close
3	Comfort Massage.	Answer: ok, comfort massage
4	Relax massage.	Answer: ok, relax massage
5	Full body massage.	Answer: ok,full body massage
6	Neck and shoulder massage.	Answer: ok,Neck and shoulder massage
7	Back and waist massage.	Answer: Ok,back and waist massage
8	Stretch massage.	Answer: ok,stretch massage
9	Fixed massage.	Answer: ok,fixed massage
10	Change the other mode.	Answer: Ok, change the other mode
11	Go little down.	Answer: Ok, go little down
12	Go little up.	Answer: Ok, go little up
13	Open the air pressure.	Answer: OK, Open the air pressure
14	Close the air pressure.	Answer: OK , Close the air pressure
15	Up the seat position.	Answer: Ok, Up the seat position
16	Down the seat position.	Answer: Ok, Down the seat position
17	Stop adjustment.	Answer: Ok, stop adjustment

Method of usage

5.Bluetooth Player Operation

- 1.Enter the smart device manual and open the Bluetooth function to search the new Bluetooth devices .
- 2.Will find the bluetooth named like (IMCM-XXXX),choose it to pair with the chair .
- 3.Turn on the Music Player in the smart device .

6.Turn off the power and stop massage.

- When pressing the power button during the massage, it will stop all the massage functions immediately, the backrest and footrest will go back to the default posit on.And when the massage time up, the massage hand will go back to the default position, all the massage function will stop, the backrest and footrest will not go back to the default position.
- Cut off the power of the whole machine. Figure (switch power off)

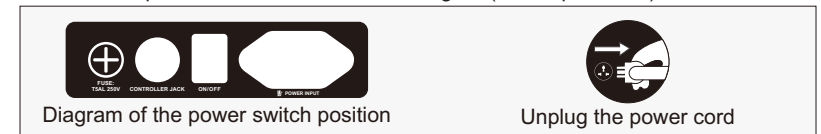

7.The calf installation.

- After connecting the wires and the air hose between the chair seat and the leg rest , unfasten the fixed pipe belt and insert the connecting part into the seat frame (figure 1).
- Place the round tube from calf left and right sides to the legs brackets.(figure 2)

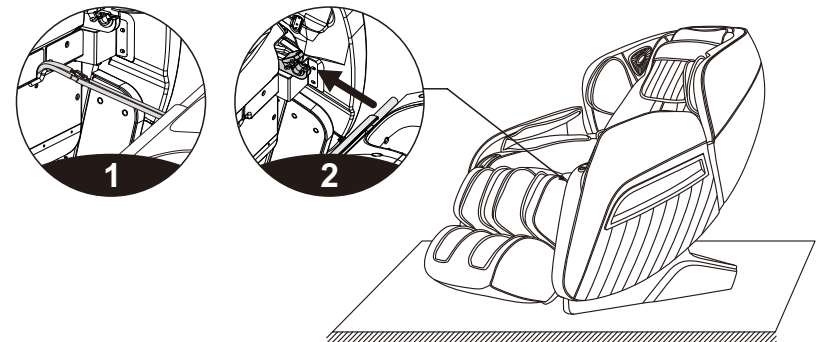

Method of usage

- Then turn the legs fixing cover over the round tube on both sides of the legs (figure 3)
- Then use 2pcs M4 screws fix the legs on the massage chair, turn up and down to check if there are any problems, the wires and air hose get stuck or not, finish the installation. (figure 4)

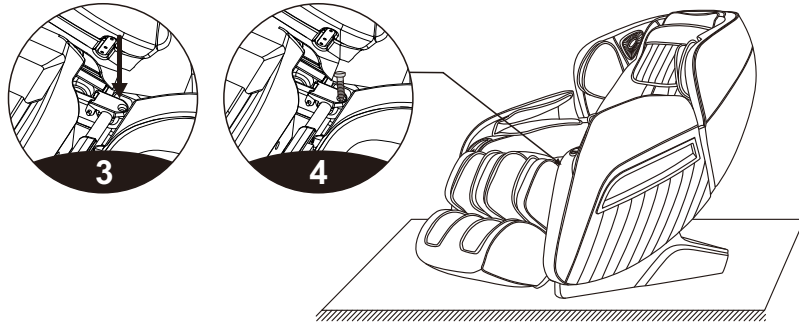

8. Head cushions and backrest pad's dismounting and use manual

- The head cushion allows you to control the intensity of the neck and shoulder massage. You can decide whether to use the head cushion (Recommend to use). The backrest cushion and the backrest is connected by zipper (1), head cushion and the backrest cushion connected by the Velcro as show in the illustration (2).

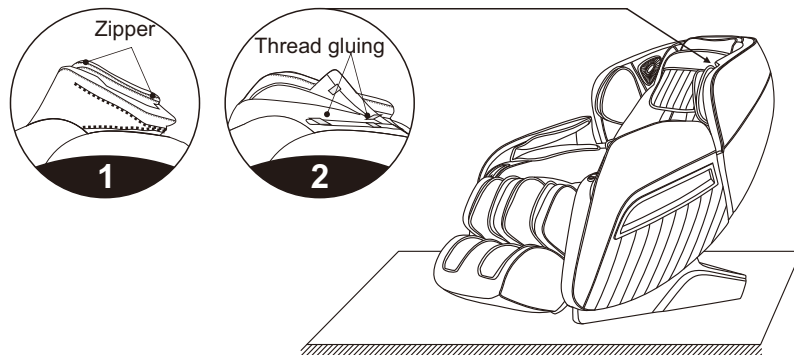

Method of usage

9. Floor Protection

- Put the heavy massage chairs on the wood floor for a may damage the floor, so please place a carpet or other object to avoid this damage.

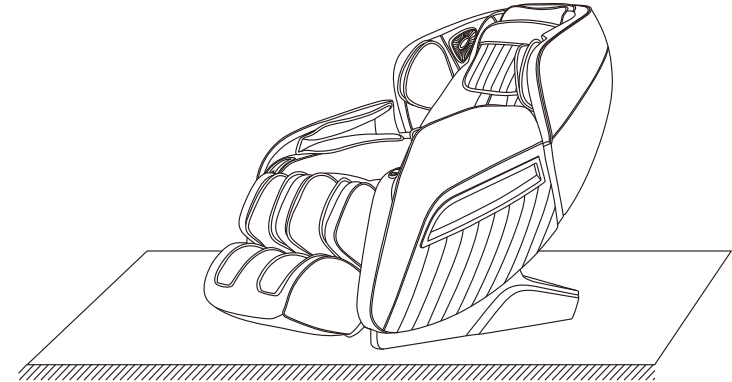

Caution: Do not move the chairs with its wheels on wood floor, rough ground or in a narrow space. Two people are required to lift the chair. During the lifting period, take the calf rest end sealing plate and backrest cover grooves as the force-bearing point(Please do not lift armrest directly.)

10. Method of movement

- Make sure that all wires are far above the ground, tilt the backrest backward to a certain degree (with the gravity center resting on the wheels), push the chair forward or backward with your hands and finally resume the chair to the normal position in a slow and gentle manner.(Note: During movement you must turn off the power first and then unplug the power cord and the controller cord.)

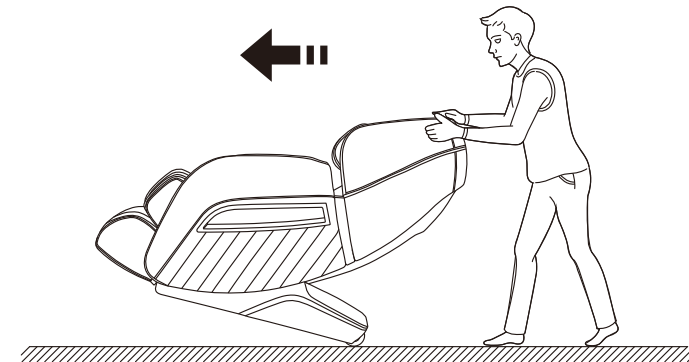

Warning : Massage chair rear wheels are only suitable for short distance movement for long distances, pls use other assistive tools to move the massage chair.

Product specification

Model: A305

Name: Massage Chair

Rated voltage: 110-120V~ 60Hz
220-240V~ 50Hz/60Hz

Rated power input:120W

Rated time: 20Min

Safety structure: Class I

Material introduction: PVC, PA, steel parts and electric & electron parts

MATERIAL	PU	LEATHER	CLOTH	WOOD