

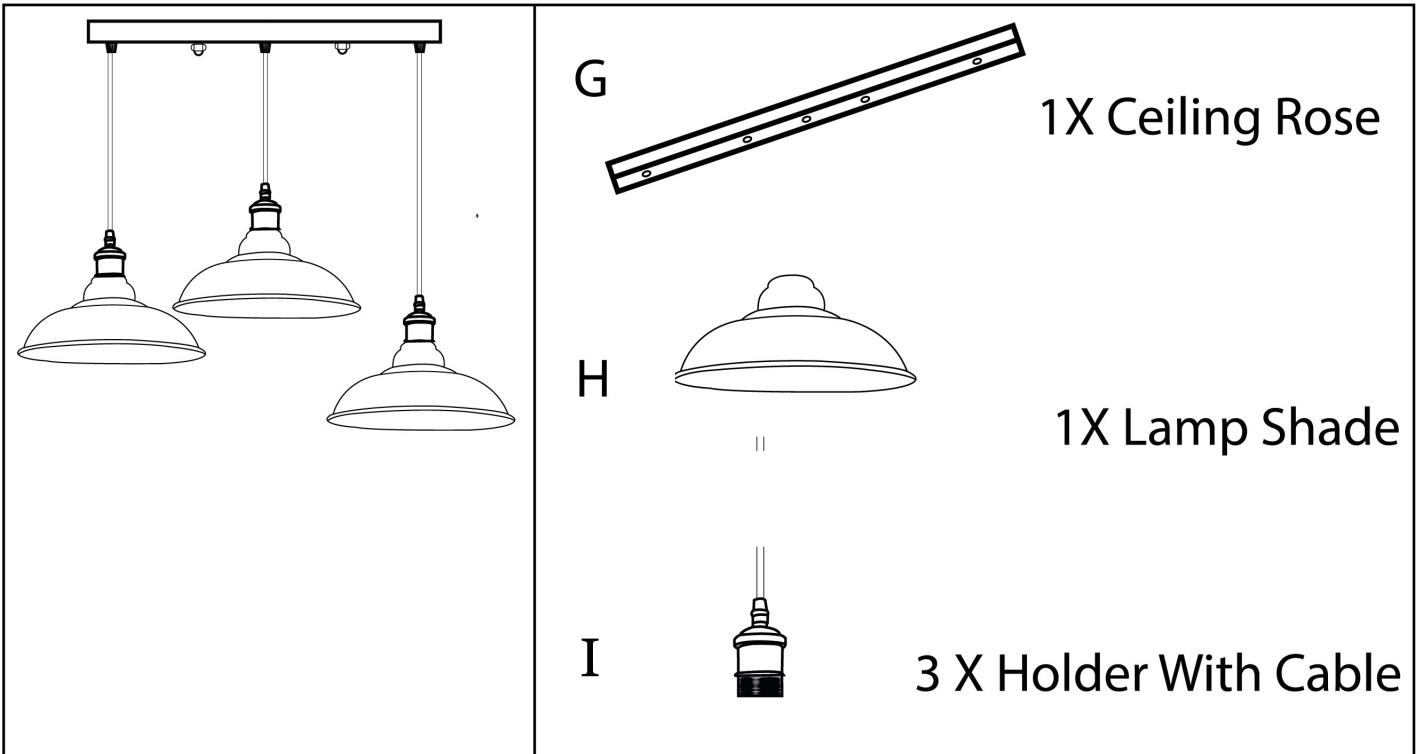







# Vintage Metal Pendant Lamp Assembling Instruction



A		1
B		2
C1		3
C2		3
D1		2
D2		2
E		2
F		2

\* The relevant explanation is on Page No:1

# Vintage Metal Pendant Lamp Assembling Instruction

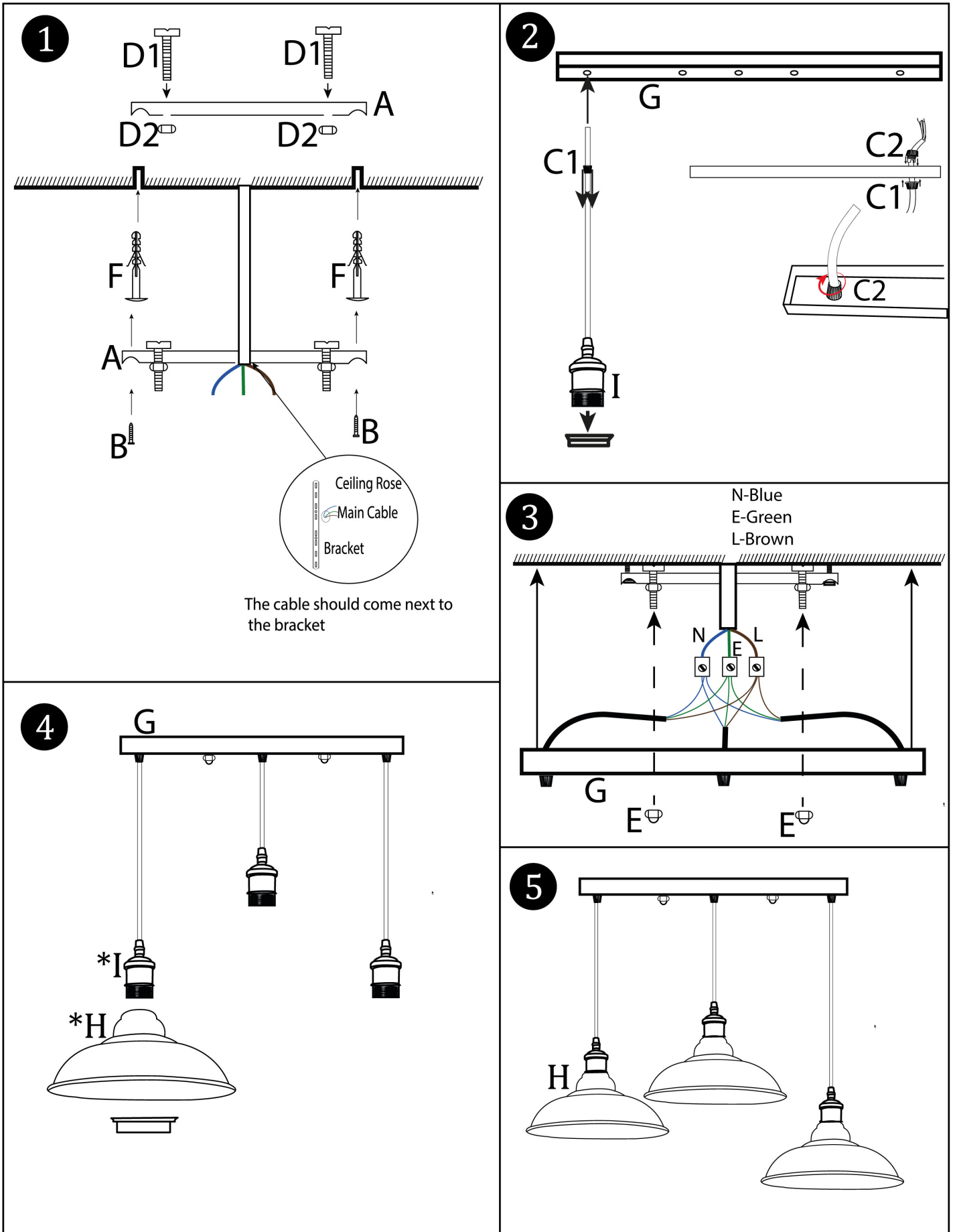

\* please refer the last page for compatible lamp shades & pendant holders

# Compatible Pendant Holders and Lamp Cages

## Pendant Holder With Cable - H

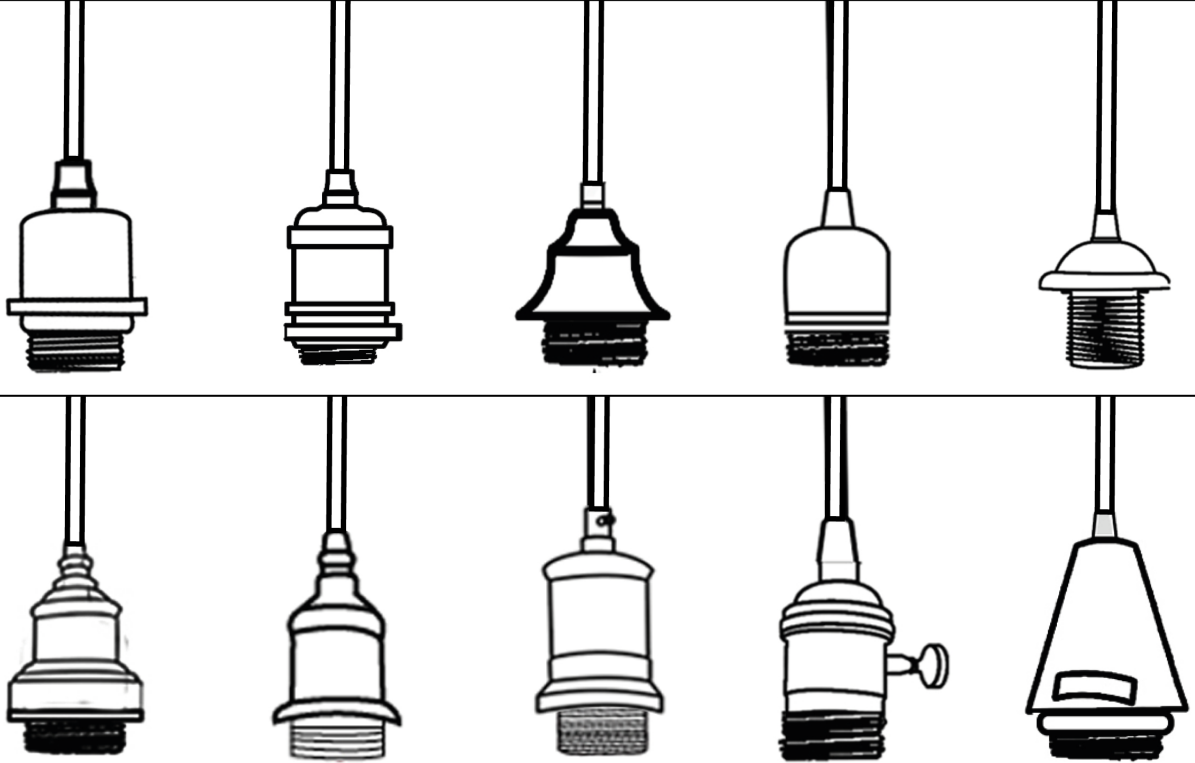

## Pendant Lamp Cages - J

