

CHARLOTTE V2

3-SEATER SOFA

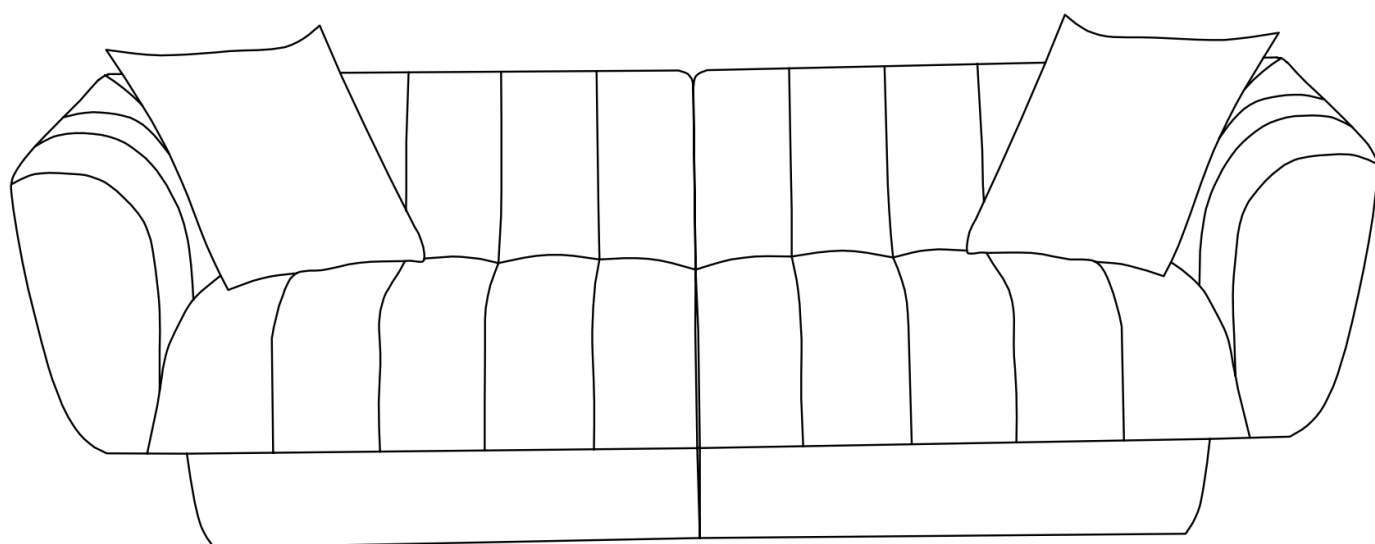

ASSEMBLY INSTRUCTIONS

Thanks for purchasing from Minimore

Before you start, here are some helpful advice:

1. We suggest you spend a short time reading through this leaflet and then follow the simple step-by-step instructions.
2. Owing to the size and weight of the sofa, we recommend that it is assembled by two adults, on a carpeted or padded area, in the room that it is intended for. Approximate assembly time: 20 minutes.
3. Please do not use any tools other than those provided or recommended in these instructions.
4. Please do not throw away any of the packaging or the instruction until you have checked all the components and hardware and the furniture is fully assembled. Please ensure that the packaging is disposed of in a safe and environmentally friendly way.
5. Assemble all components loosely until advised to tighten. Depending on use, it may be necessary to tighten the components from time to time, so please save the tools that have been provided.
6. Please keep all fitting out of reach of children.
7. If you have any question about the assembling, cleaning and using, you can feel free to contact with us: info@minimoreliving.com! If you love our product, we will be very happy to get your 5 star review. Thankyou so much!

Component

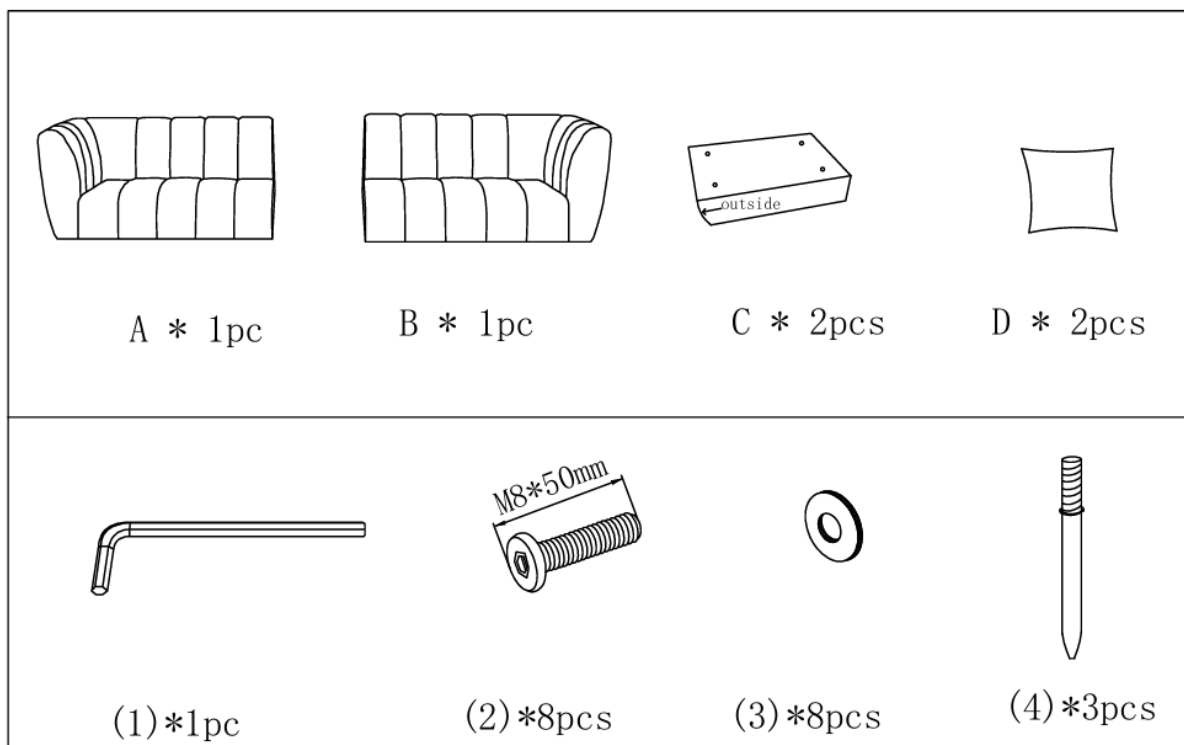

1

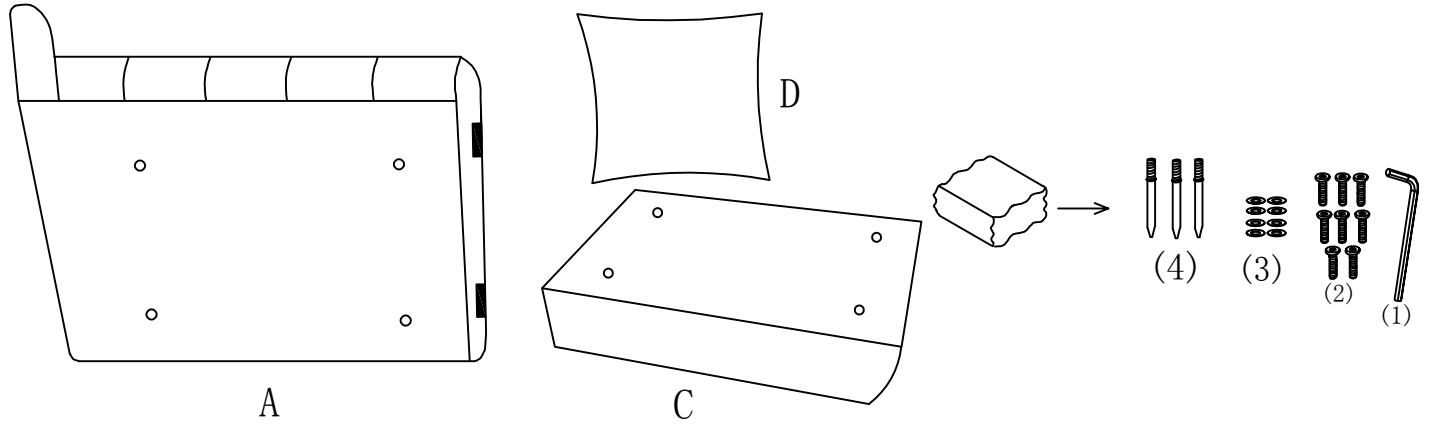
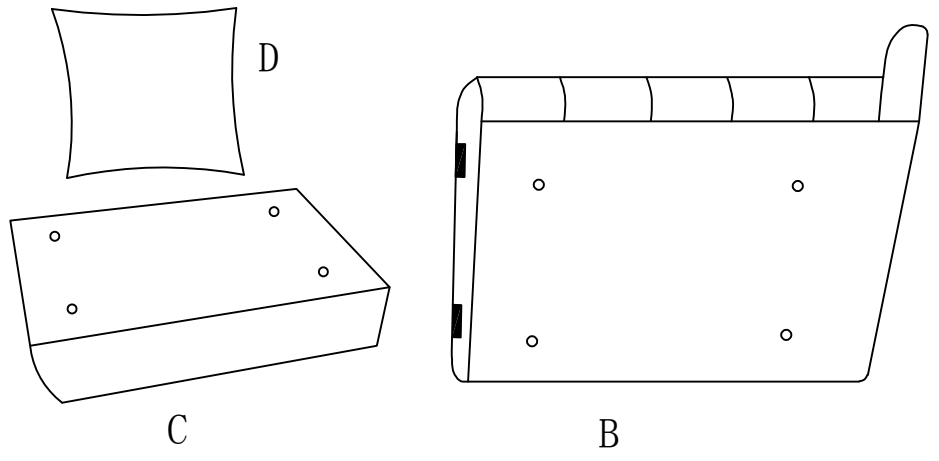

2

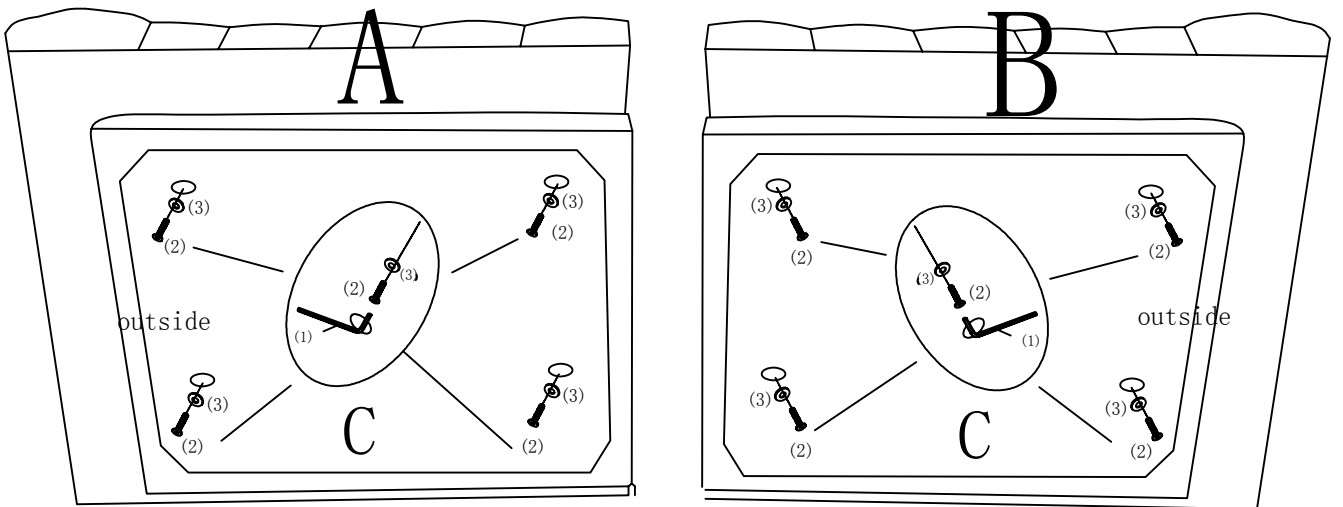

3

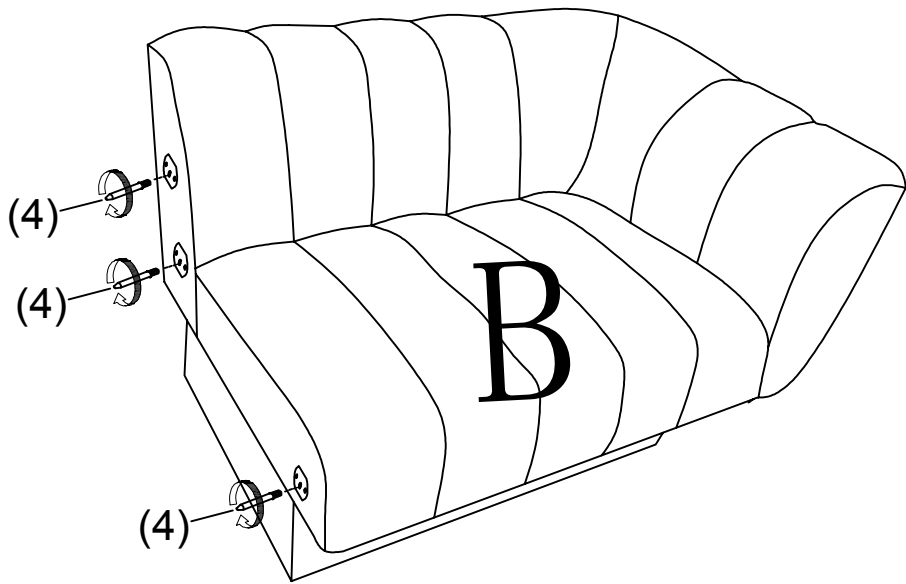

4

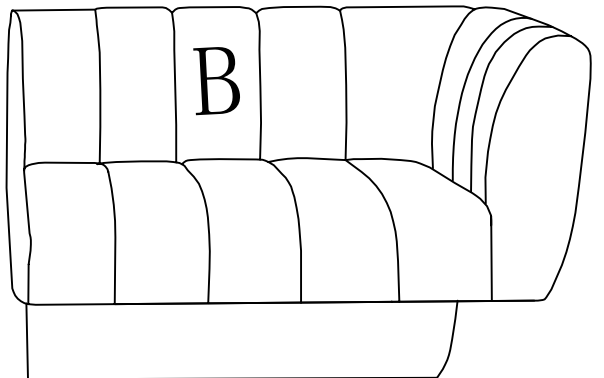
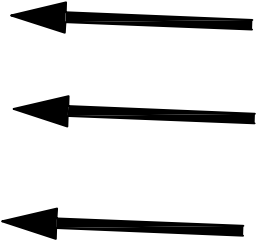
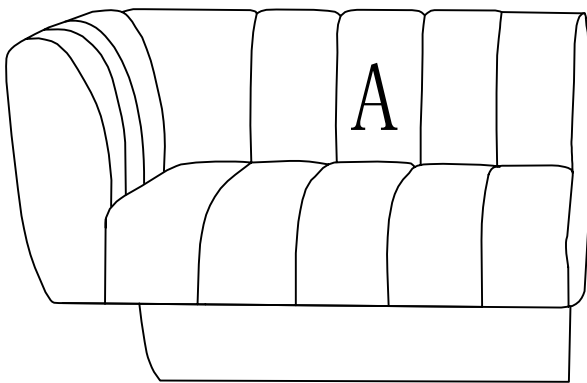
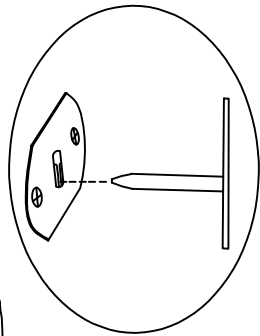

5

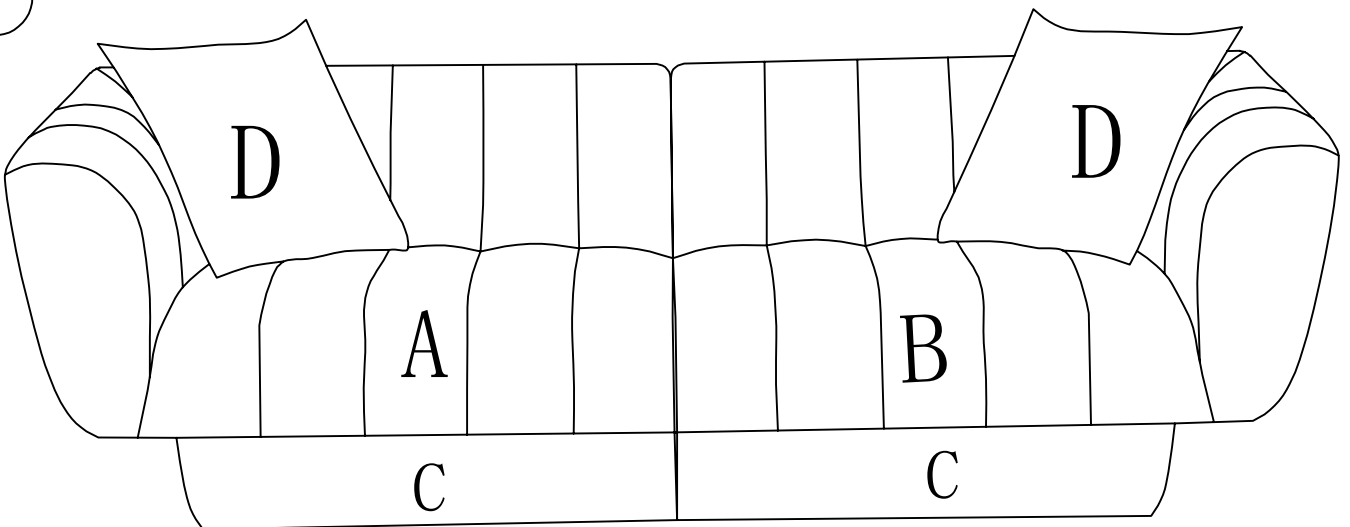

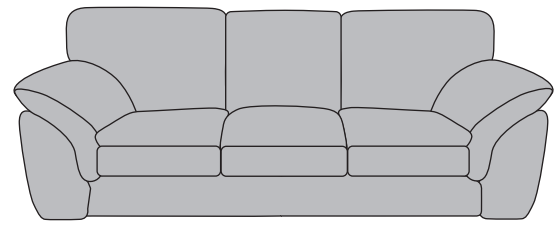
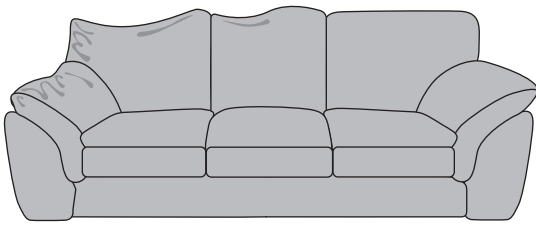

DK – POLSTER PUDE PLEJE

Din sofa har været længe undervejs. Før du tager den i brug, form den, så den får sit oprindelige udseende. Det er normalt for en sofa at miste lidt af sin facon under transport, men hvis du følger instruktionen, vil du få en ny og flot sofa!

UK – UPHOLSTERY CUSHION CARE

This product made a long journey to reach you. Before using, please reshape the cushions to restore to it's original beauty. It is normal for the product to be slightly misshaped whilst packed in transit. But if you follow the instructions, all will be well.

DE – POLSTER – UND KISSENPFLEGE

Dieses Produkt hat einen langen Weg hinter sich. Bevor Sie es benutzen folgen Sie bitte der Anleitung und passen Sie die Kissen an um diese wieder in Form zu bringen. Dass Polstermöbel nach dem Transport etwas verformt sind ist normal und kann mithilfe von wenigen Handgriffen behoben werden.

FR – CONSEILS D'ENTRETIEN DE VOS MEUBLES EMBOURRÉS

Votre produit a fait un long voyage. Avant de l'utiliser, il se peut que vous ayez à ajuster les coussins afin de leur rendre la forme initiale. Il est normal que les coussins se déforment pendant le transport. Suivez les instructions ci-dessous afin de les donner du volume à nouveau.

ES – TAPICERÍA CUIDADO DE LAS ALMOHADAS

Su sofá ha tenido un viaje largo. Antes de montarlo, darle forma para que vuelva a su aspecto original. Por lo general, es normal que el sofá se deforme un poco durante el transporte, pero si usted sigue las instrucciones, conseguirá un sofá nuevo y bonito!

1

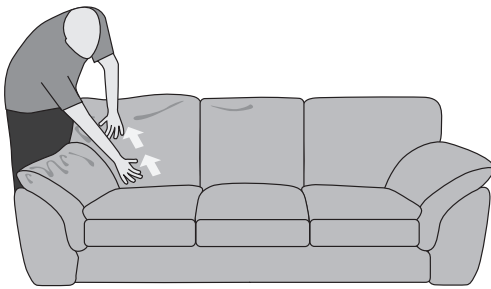

1. Juster rygpuderne med begge hænder. Start fra bunden og bevæg dig opad som vist på tegningen.

1. Adjust the back cushions with both hands, starting from the bottom and moving to the top as in the picture.

1. Passen Sie die Rückenkissen mit beiden Händen an, indem Sie sie, wie links im Bild dargestellt, von unten nach oben glatt streichen.

1. Ajuster les coussins du dossier avec les deux mains. Commencez par le bas vers le haut comme sur l'image.

1. Ajuste de nuevo la almohadilla con ambas manos. Comenzando desde abajo hacia arriba como se muestra en la ilustración.

2

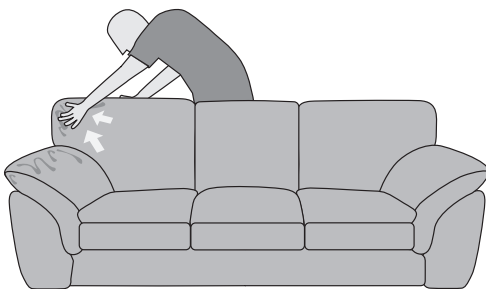

2. Herefter "krammer" du fylDET i hynderne i de øverste hjørner.

2. Now, gently caress the fillings into the top corner.

2. Streichen Sie die Füllung sanft in die oberen Ecken der Kissen.

2. Répartir le rembourrage vers les coins du haut.

2. A continuación, alisar los cojines en la esquina superior.

3

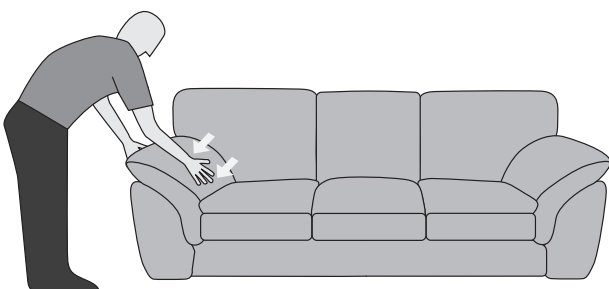

3. Hvis modellen har armpuder, "kram" dem ligeligt fra midten og udad.

3. If the model has arm pads, caress them evenly from the center towards the outside border.

3. Hat das Modell Armkissen, so streichen Sie den Inhalt bitte von der Mitte in die äußeren Ecken.

3. Si votre modèle a des coussins accoudoirs, répartir le rembourrage de ceux-ci du centre vers l'extérieur.

3. Si el modelo tiene almohadas en los brazos, alisar las almohadas desde el centro hacia afuera.

HANDLING INSTRUCTIONS GEBRAUCHSANWEISUNG INSTRUCCIONES DE MANEJO HÅNDTERINGSVEJLEDNING INSTRUCTIONS DE MANUTENTION

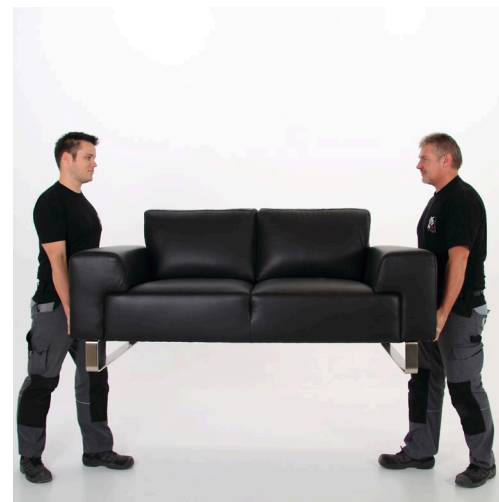

UK: The plastic wrapping must always be torn - never use a knife.

DE: Die Plastikverpackung muss immer mit der Hand auf gerissen werden - bitte kein Messer benutzen.

E: El plástico envolvente debe ser siempre rasgado - nunca use cuchillos.

DK: Plastikemballagen skal altid rives i stykker - brug aldrig en kniv.

FR: L'emballage plastique doit toujours être déchiré - ne jamais utiliser des objets pointus qui pourraient endommager le revêtement.

UK: Never pull nor lift in the back cushions and/or the arm cushions.

DE: Das Anheben oder Ziehen an dem Rückkissen und/oder Armstühlen ist zu unterlassen.

E: Nunca tire ni levante por los cojines traseros y/o por los brazos acojinados del mueble.

DK: Løft eller træk aldrig i ryg- og/eller armhynder.

FR: Ne tirez jamais, ni levez les coussins de dossier et / ou les accoudoirs.

UK: Always lift the sofa from underneath.

DE: Das sofa immer von der Unterseite anheben.

E: Siempre levante el sofá por la parte de abajo.

DK: Løft altid sofaen under bunden.

FR: Toujours soulevez le canapé par le bas.