



MCombo

ACCENT CHAIR

with OTTOMAN

6151-4539



Toll Free(US) : 3235971109

Website : www.mcombo.com Amazon sold by: MCombo

Warranty Claim : sales@mcombo.com

Sales & Technical Questions : sales@mcombo.com sales@exacme.com











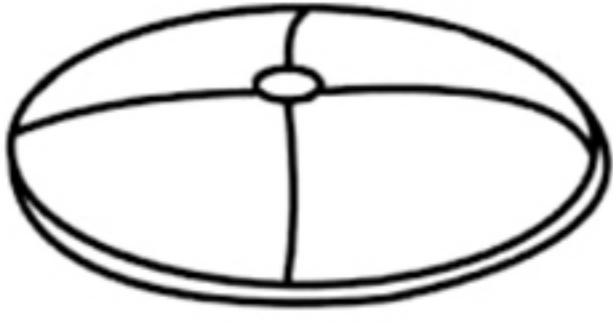
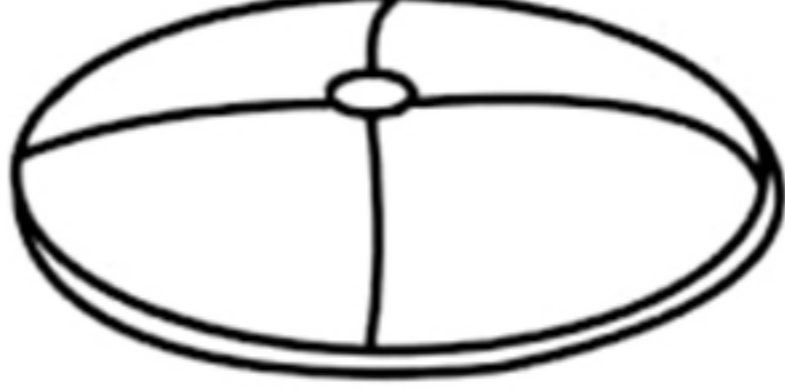
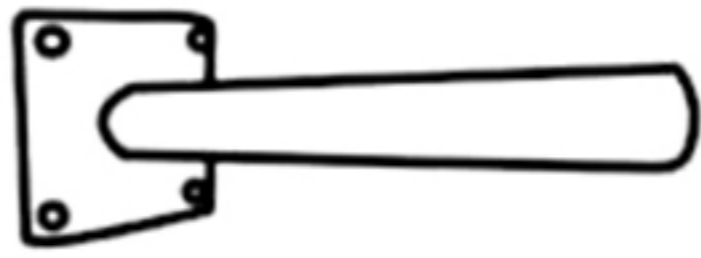

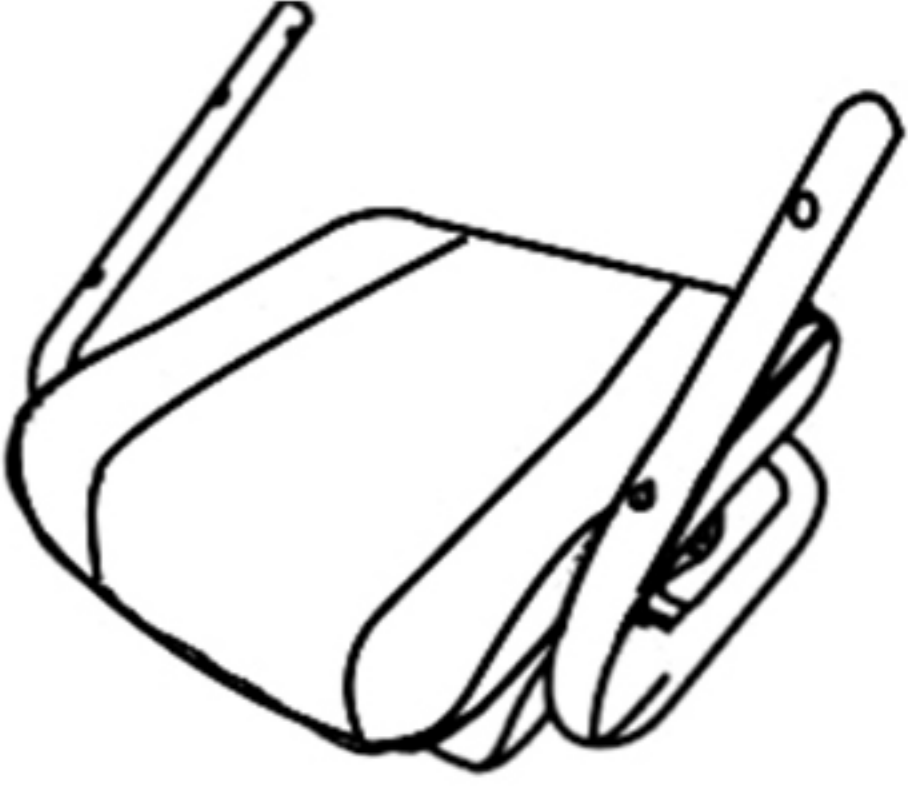
CONGRATULATIONS!

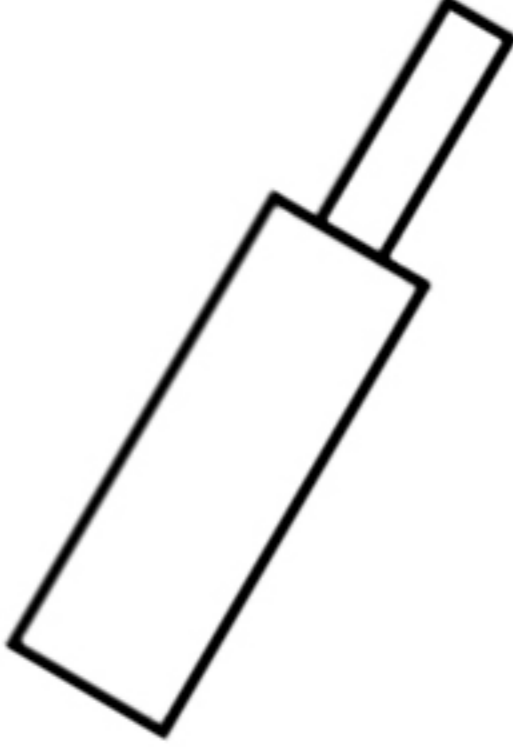
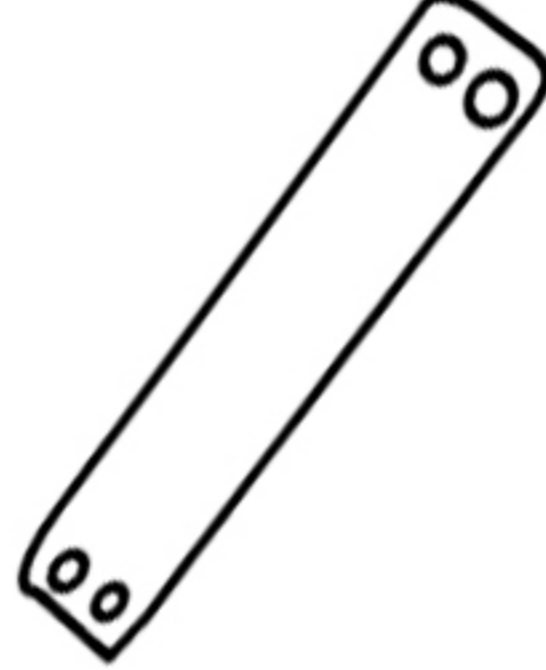
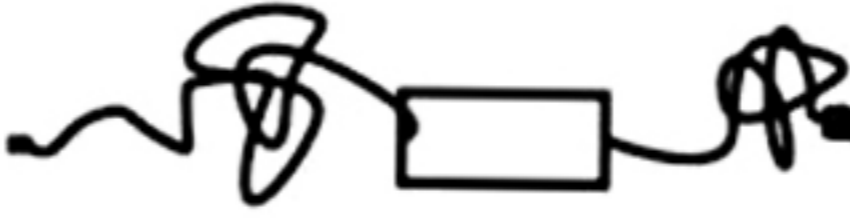
Mcombo Accent Chair with ottoman - a name synonymous with classic design and the carrier of value and quality. Our products are directly from factory and eliminated the cost of middlemen. The Accent Chair with ottoman is a high-quality shading solution to enhance comfortable feelings as you try to enjoy the nice day.

WARRANTY

- All warranties are to the original purchaser from **MCOMBO ONLY**®
- **MCOMBO**® will replace the defective parts or send replacement item provided that the warranty parts have not been subjected to misuse, abuse or improper service by the consumer, for example, damaged wire arising in consequence of negligence or improper operation.
- **MCOMBO**® All of chairs come with a 30-day return/replace policy. During this time, we will cover the shipping cost of return and replacement for defective and damaged item, through provide pre-paid return label or pick up service for customer's convenience.

PARTS LIST

 A*1 Ottoman Base	 B*1 Chair Base	 C*1 Ottoman Leg	 D*1 Ottoman Cushion	 E*1 Chair Back	 F*1 Chair Seat
 G*2 Arms	 H*1 Chair Rotating Rod	 I*2 Armrest Iron Sheets	 J*1 Power Cord	 K*1 Remote Control	 L*2 Screws M8x25mm
 M*12 Screws M6x20mm	 N*2 Screws M8x55mm	 O*1 Wrench	 P*2 Handwheel	 Q*1 Spanner	

Please remove all protective foam.

Ottoman Assembly

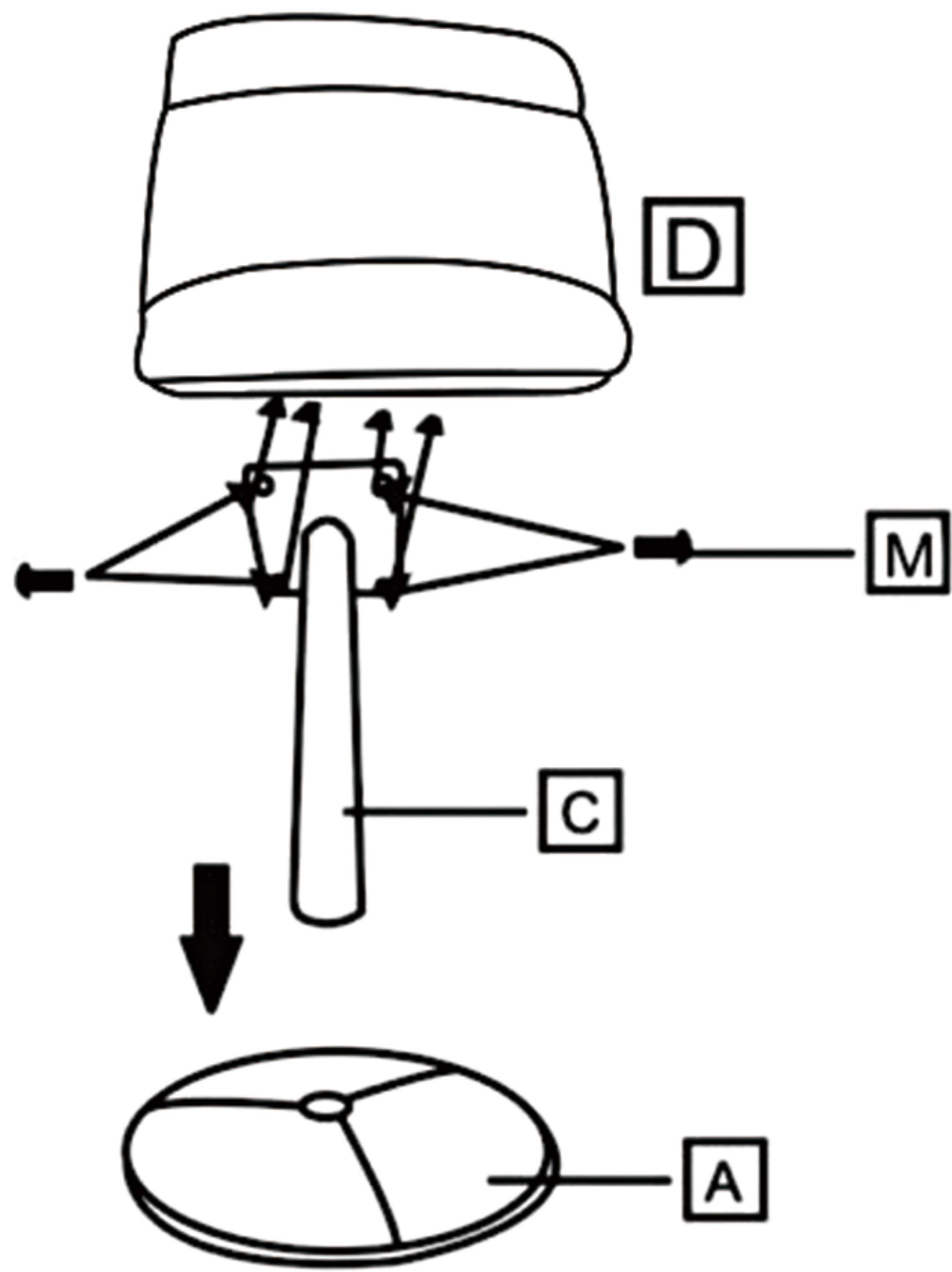

Step 1

Fix the Ottoman Base (#A) and Ottoman Cushion (#D) together with the Ottoman Leg (#C) use Screws (#M).

Chair Assembly

Step 2

Connect Chair Base (#B) and Chair Seat (#F) with Rotating Rod (#H).

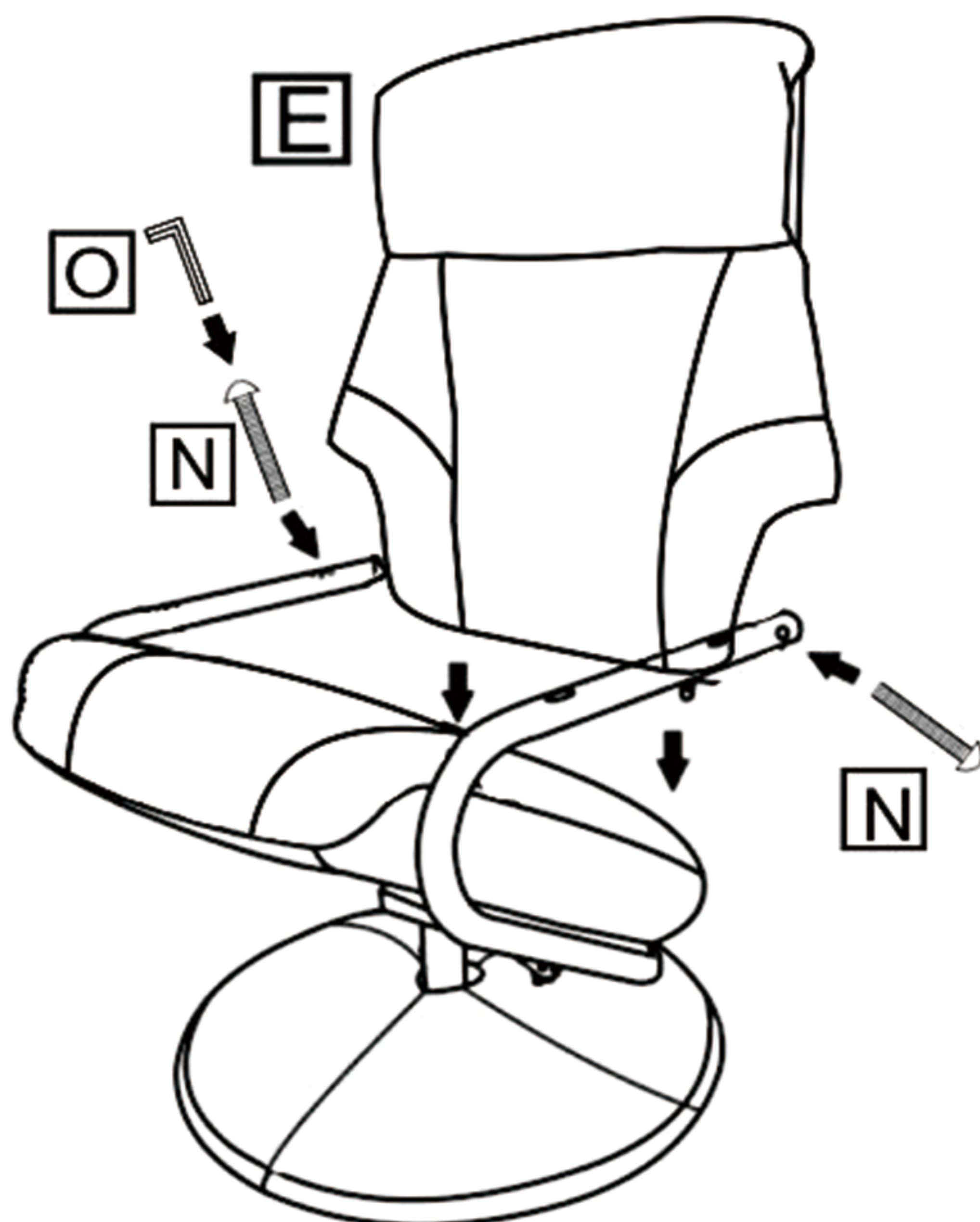
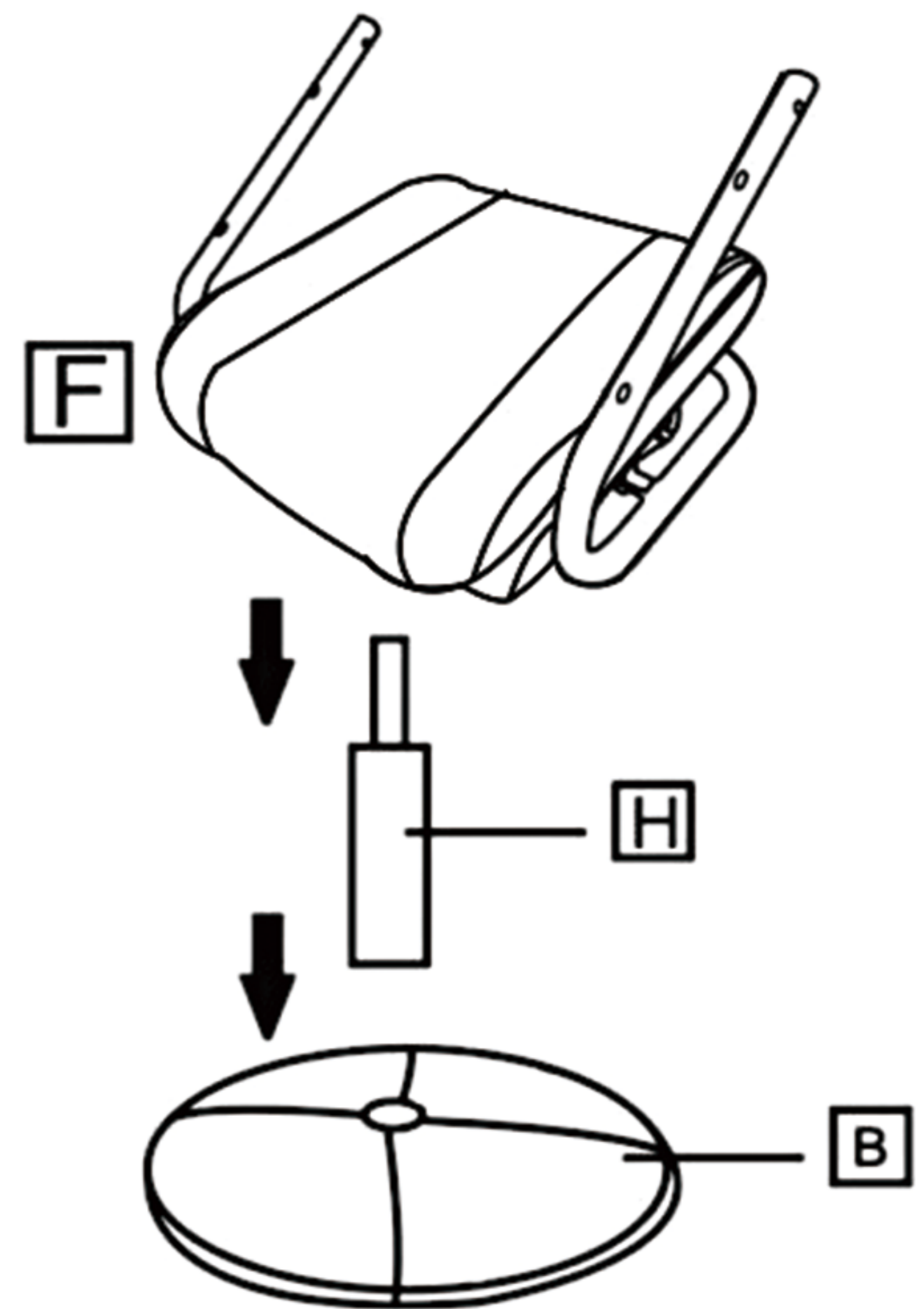

Step 3

Fix both sides of the Backrest (#E) to the armrest frame with Screws (#N&#O).

Step 4

1. Fix the small iron pieces under the backrest and behind the seat cushion with Screws (#L&#Q).
2. Fix the Handwheels (#P) to the sides of the chair.

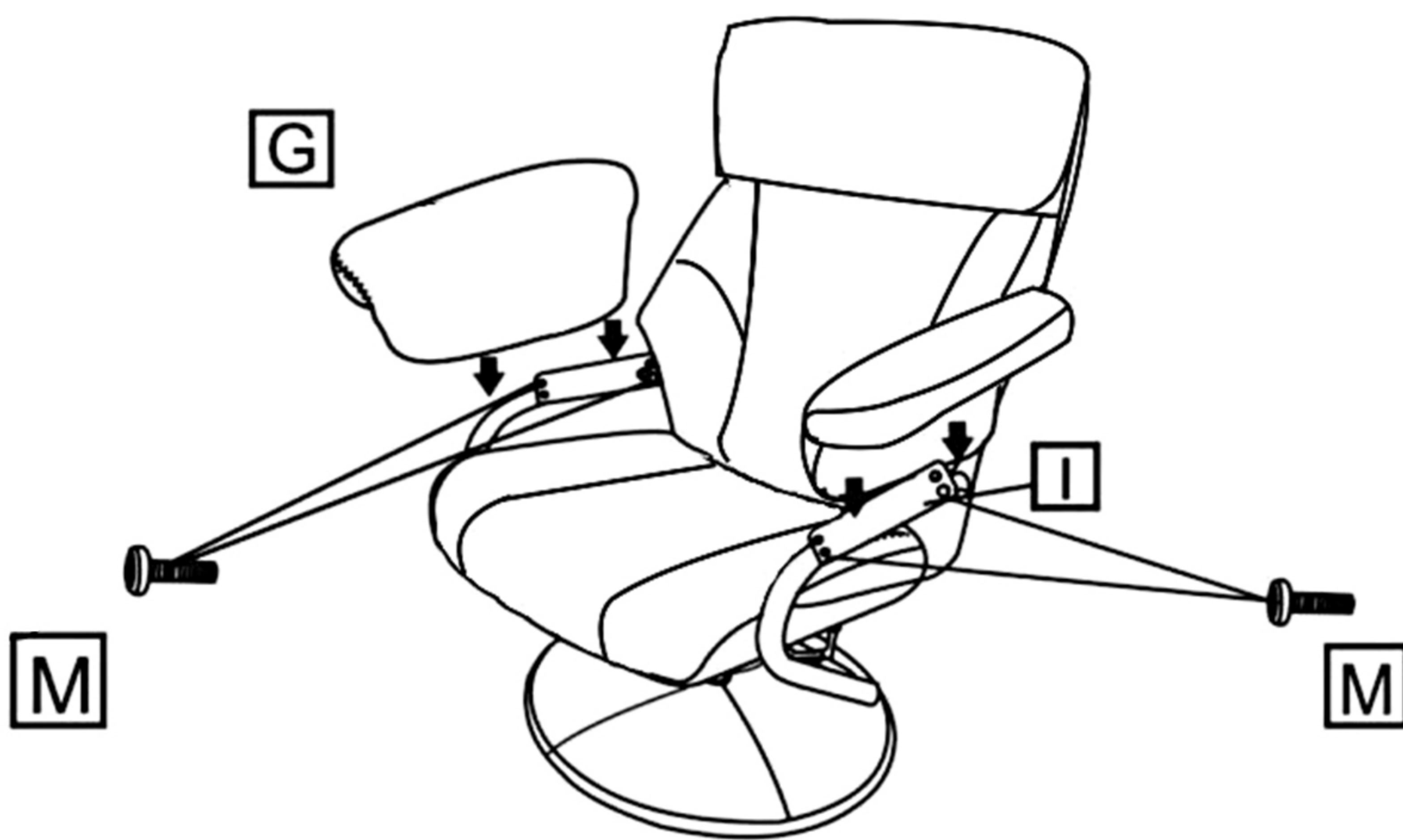
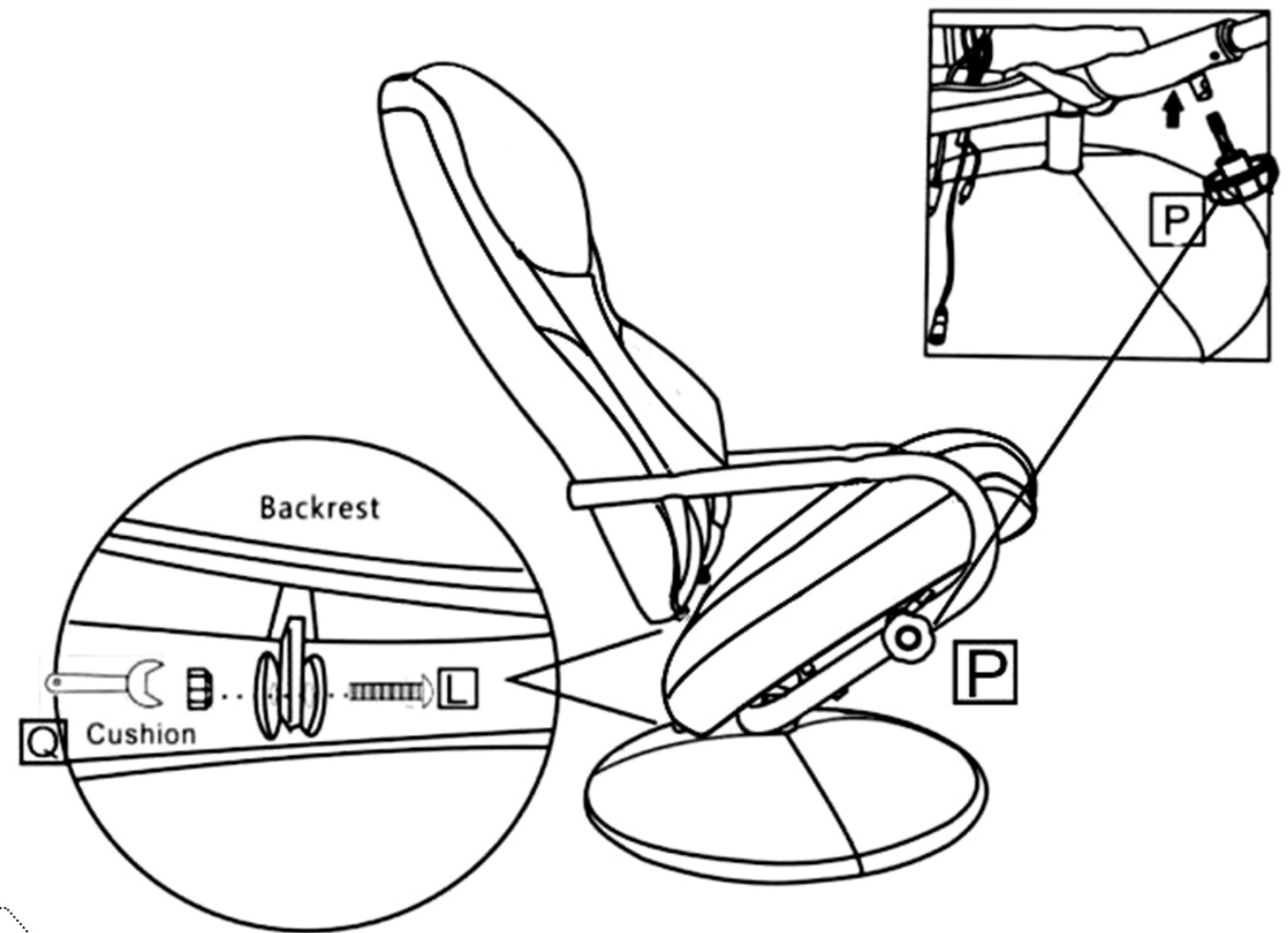

Step 5

- Fix the Armrest Iron Sheets (#I) to the armrest frame first, and then fix the Armrest (#G) to the iron sheet with Screw (#M).

Cord Connection

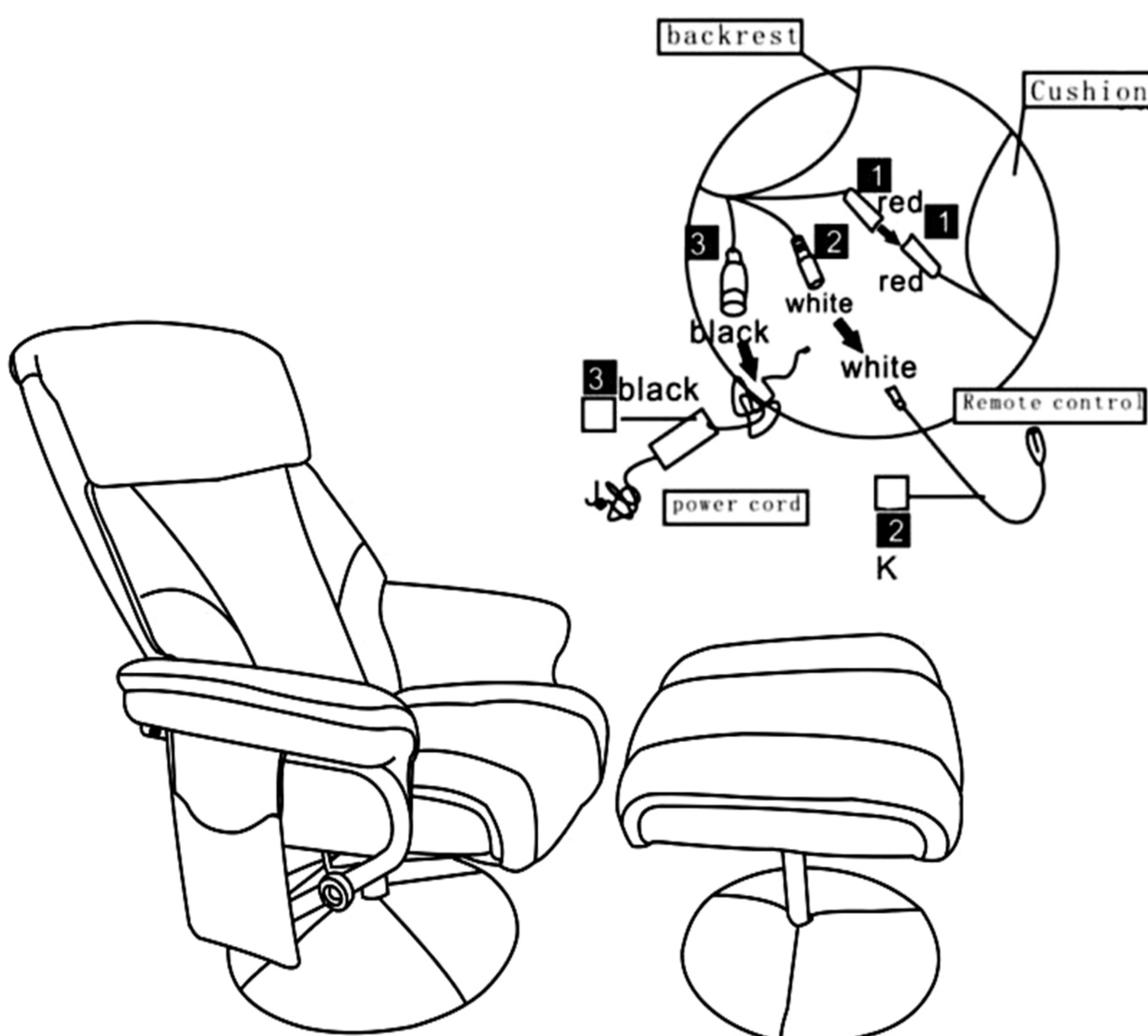

Step 6

1. Power Cord (#J-black): Connect 2 black connectors.
2. Remote Control (#K-white): Connect 2 white connectors.
3. Vibrating Cord (red): Connect 2 red connectors on the backrest and the seat cushion.

KINDLY REMINDER

If you have any questions about the product or use, please feel free to contact sales@mcombo.com