

# Assembly Instructions

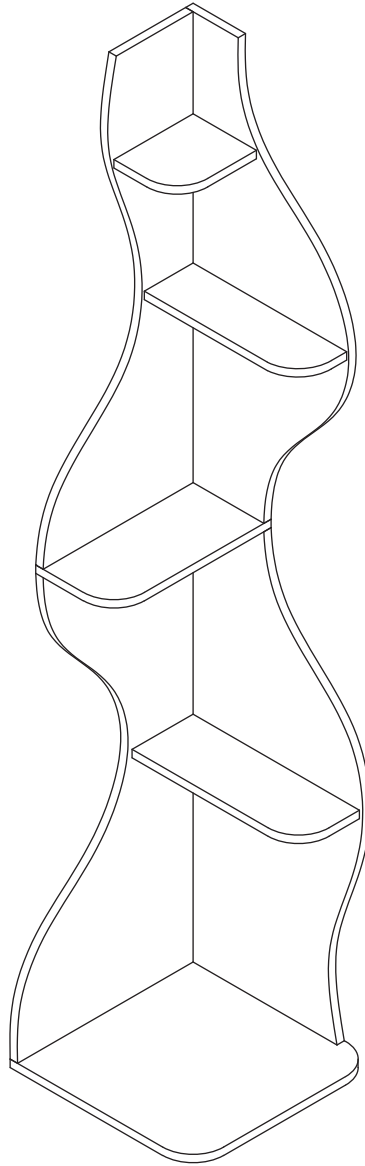

**DESIGN  
TRANSFORMS  
LIFE**

# Product Attributes

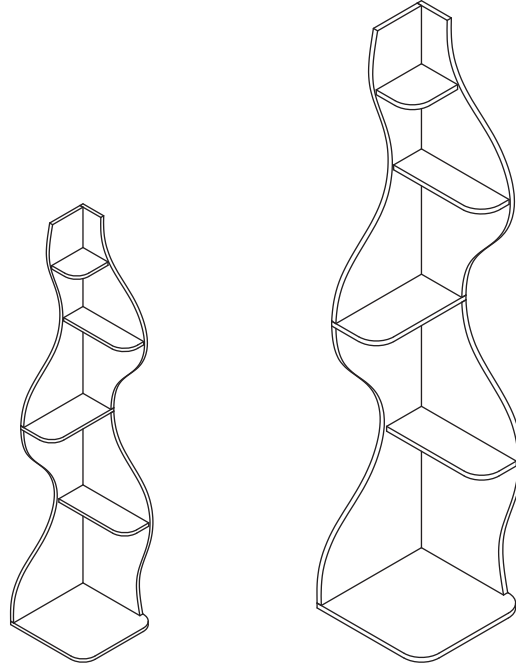

## Material

Particle Board

Plywood



## Specification

S

11.8"x11.8"x53.6"

L

15.8"x15.8"x69.4"



## Color

Walnut

Rustic

Black

White

Red

Yellow

Blue

Green

Pink

Orange



## Installation of Cams and Pins

Screw the pin into the hole. To set the cams correctly, ensure that the arrow on the cam is opening to the hole of the pin it is locking. Lock the cam by turning the cam head with a screwdriver until it is tightened. Please do not use an electric screwdriver to assemble the unit.

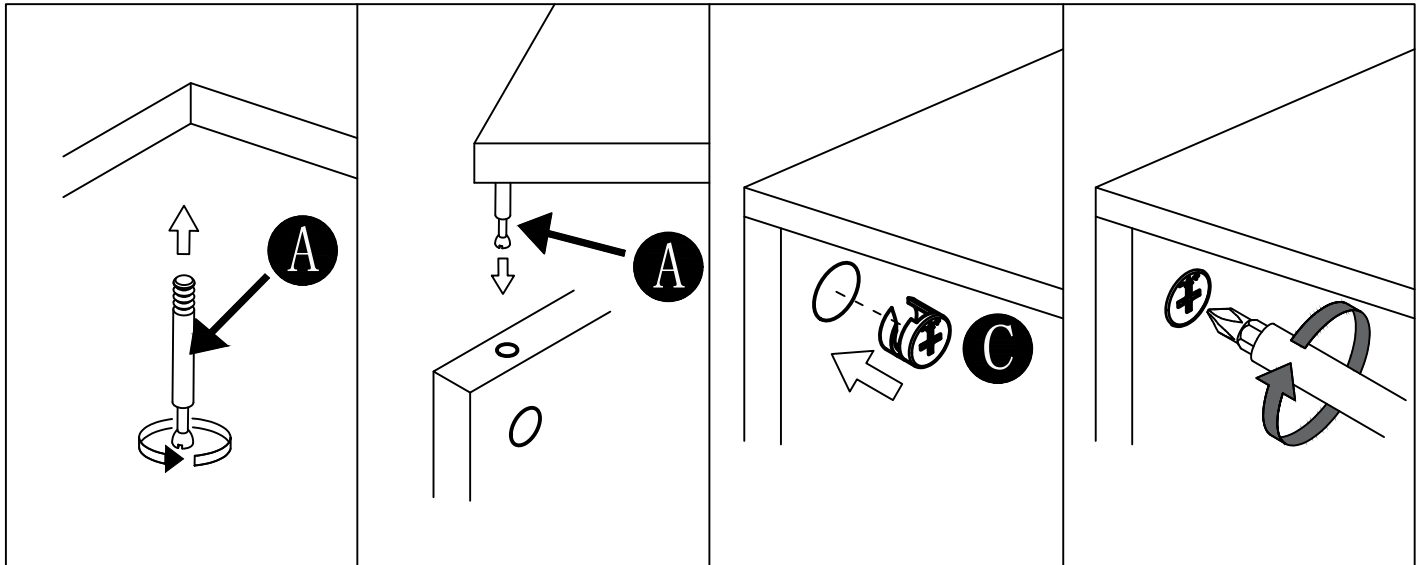

Read each step carefully before starting. It is very important that each step of instruction is performed in the correct order. If these steps are not followed in sequence, assembly difficulties will occur.

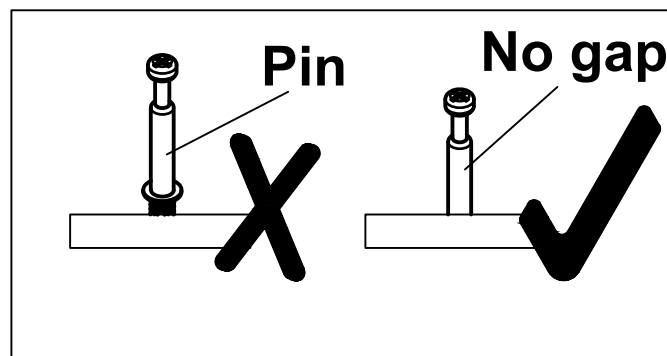

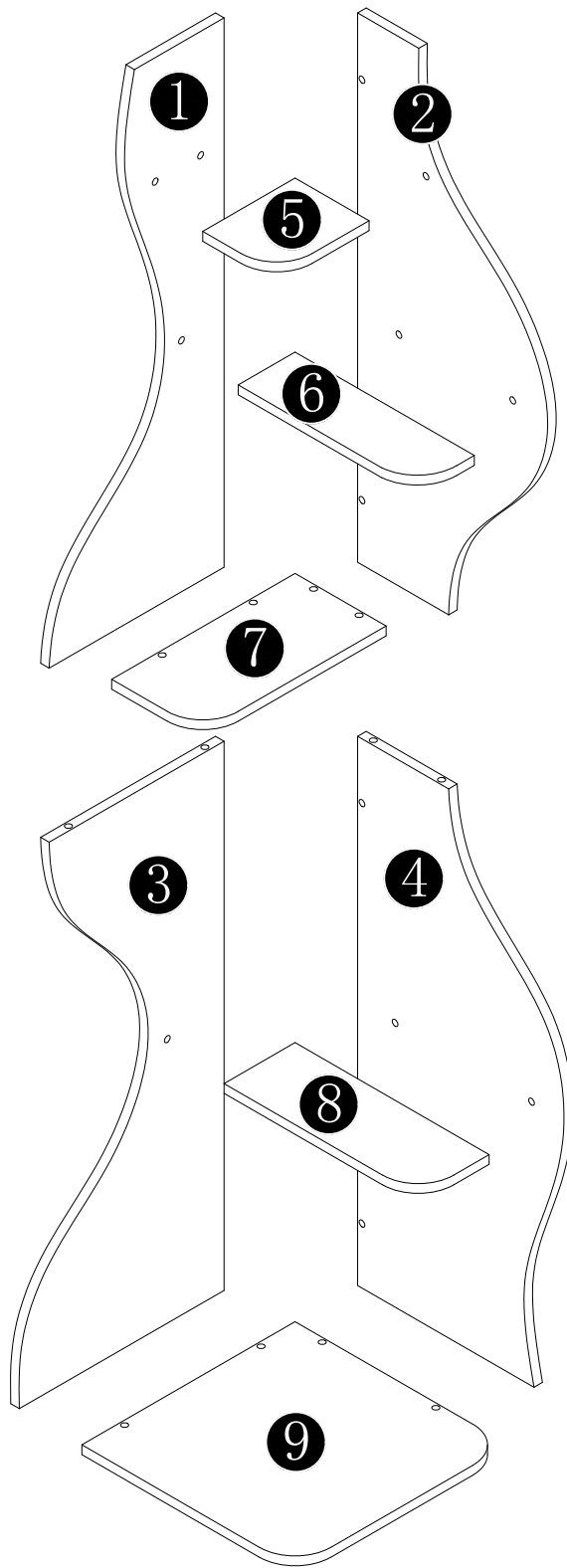



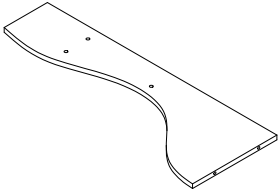
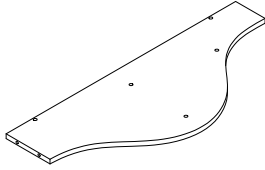
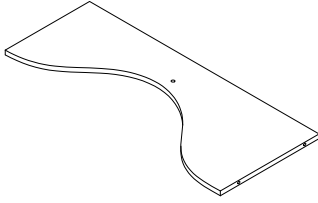
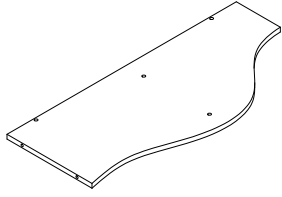
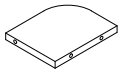
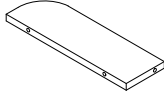
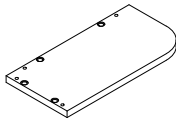
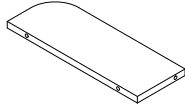
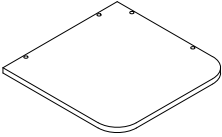

## Parts & Hardware List

 <p><b>1</b> 1pc</p>	 <p><b>2</b> 1pc</p>	 <p><b>3</b> 1pc</p>	 <p><b>4</b> 1pc</p>
 <p><b>5</b> 1pc</p>	 <p><b>6</b> 1pc</p>	 <p><b>7</b> 1pc</p>	 <p><b>8</b> 1pc</p>
 <p><b>9</b> 1pc</p>			

## Parts & Hardware List

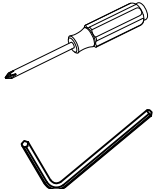
 <p><b>A</b> 4pcs</p>	 <p>M7X50MM <b>B</b> 21pcs</p>	 <p><b>C</b> 4pcs</p>	 <p>4MM <b>Y</b> 6pcs</p>	 <p>18CM <b>Z</b> 1set</p>	
--	---	--	--	---	---

1

B x3

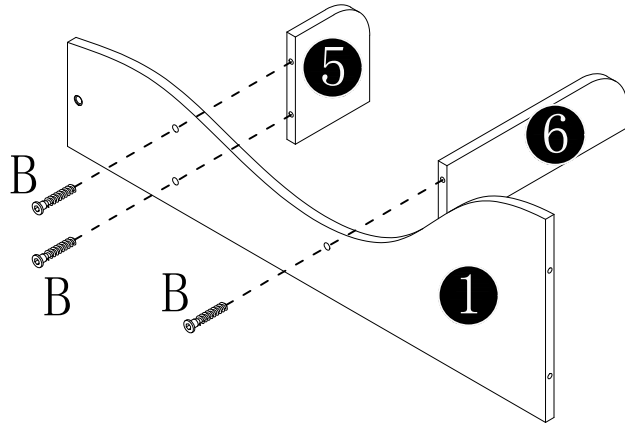

2

B x5

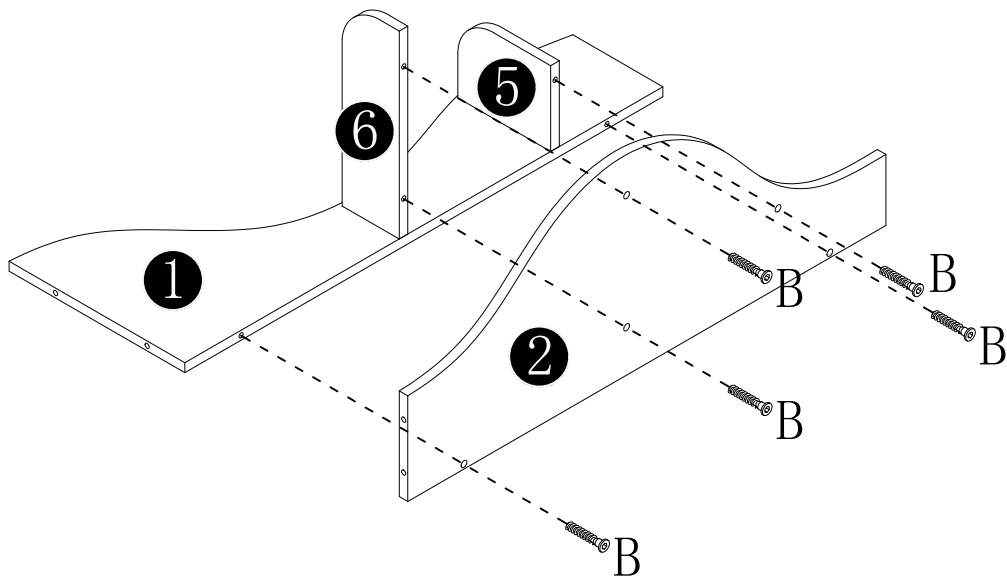

3

B x4

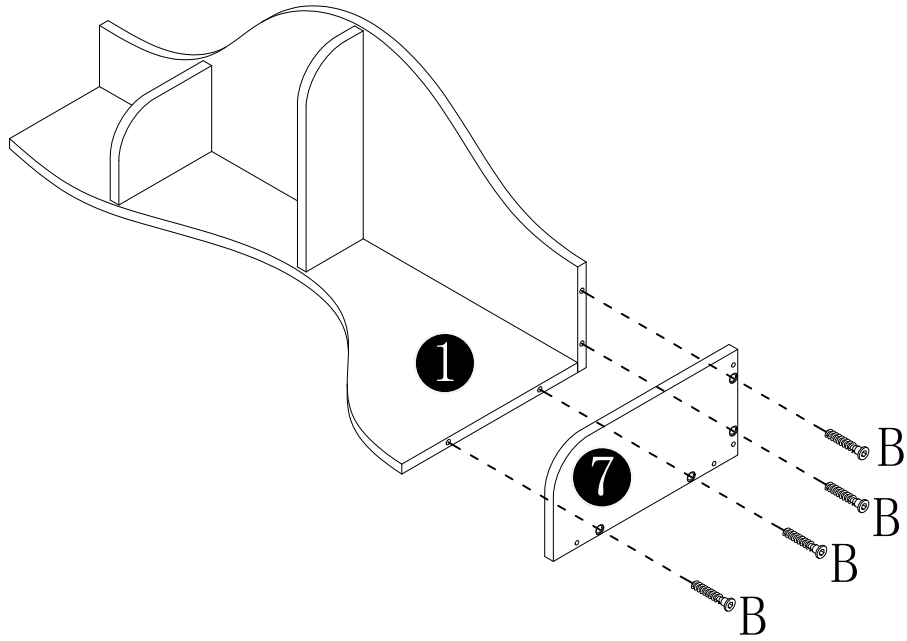

4

B x1

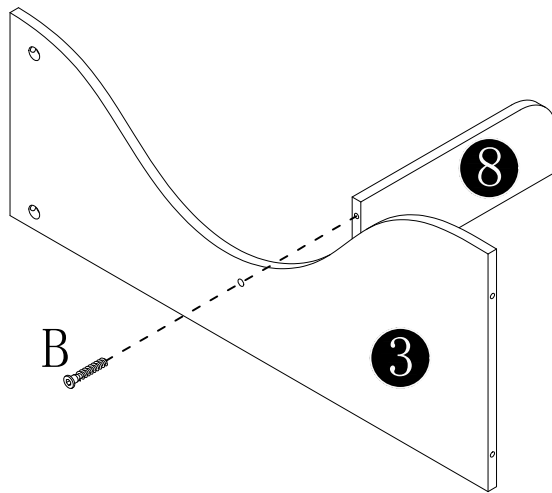

5

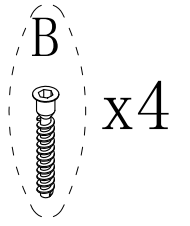
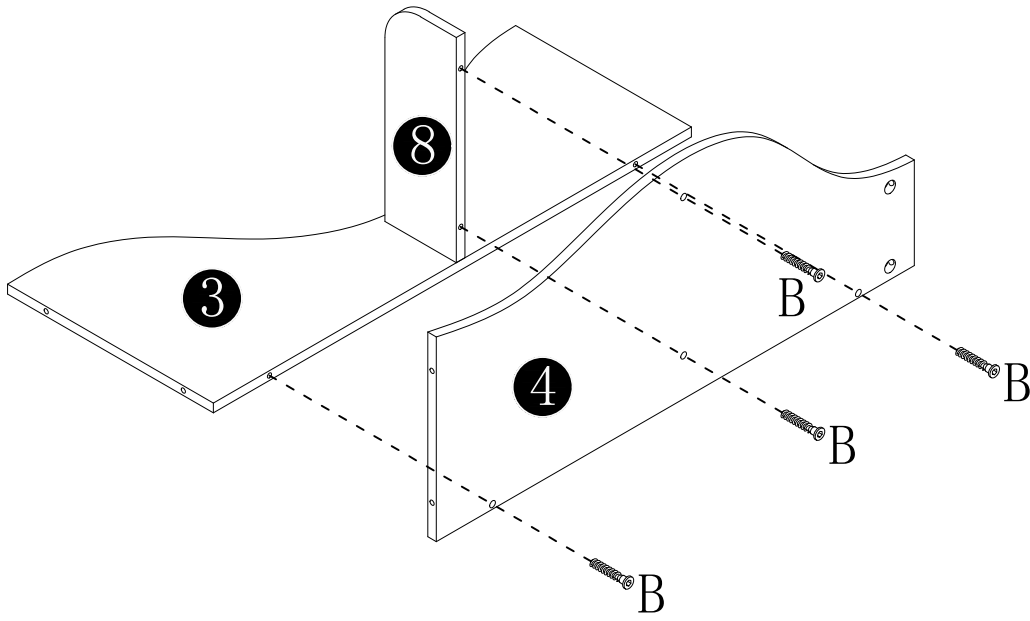

6

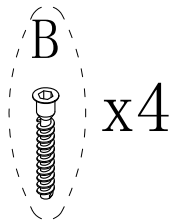
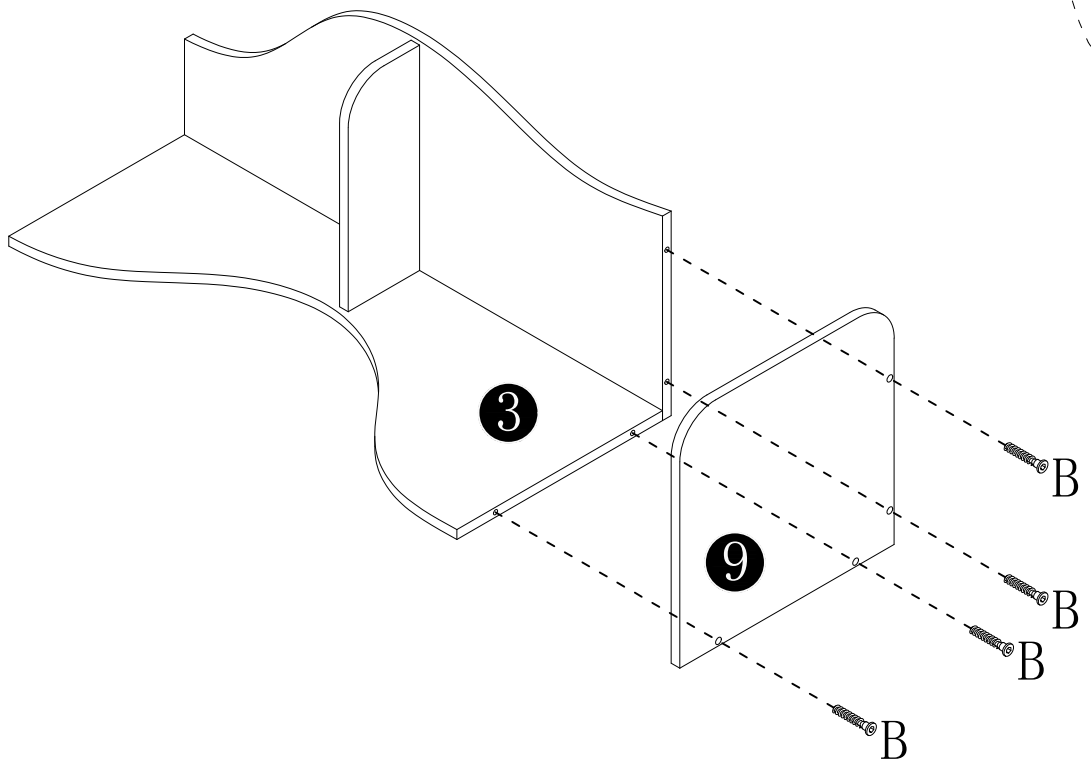

7

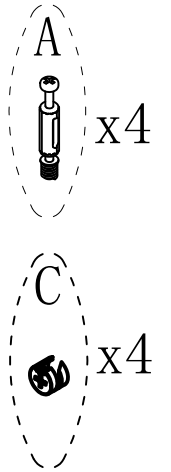
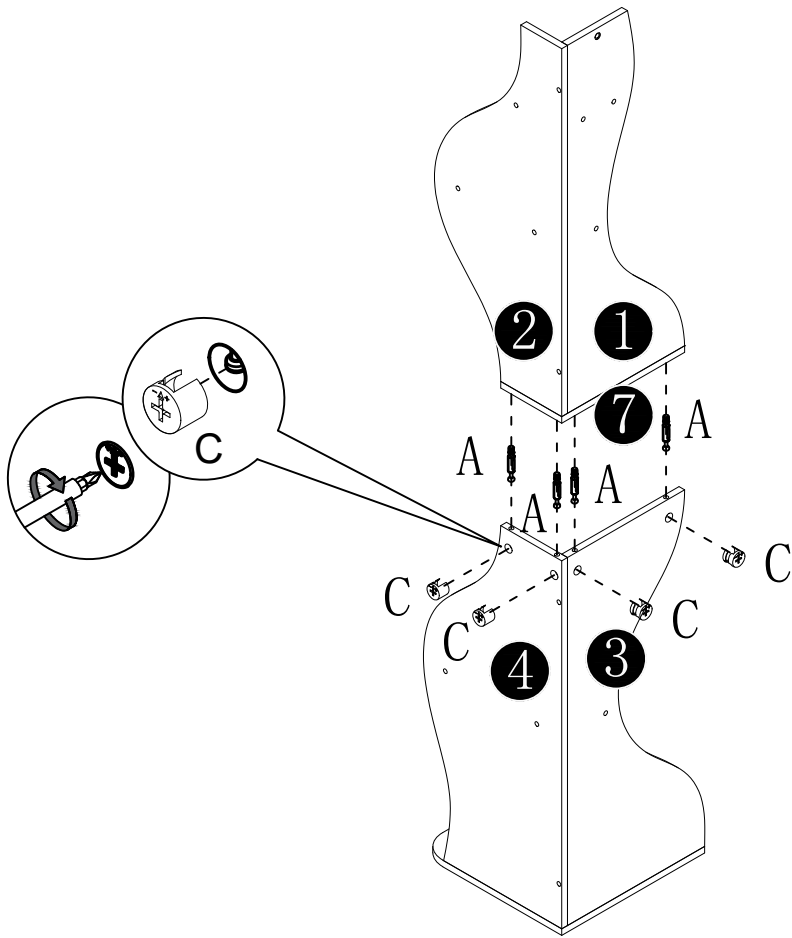

8

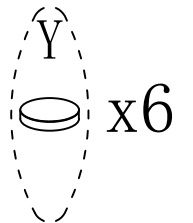
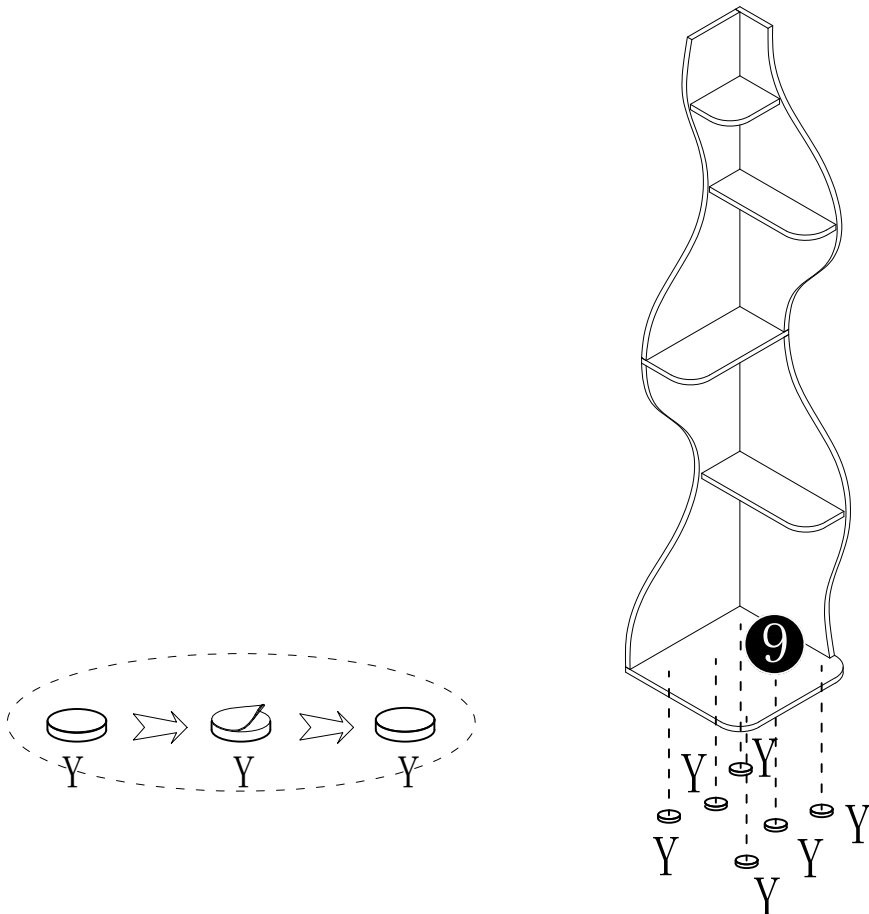

9

 **Attention: For safety and stability, we suggest you have to secure the anti-tip accessories to the wall to prevent tipping, injury, and property damage.**

 **Z** x1

