

# Installation & Assembly

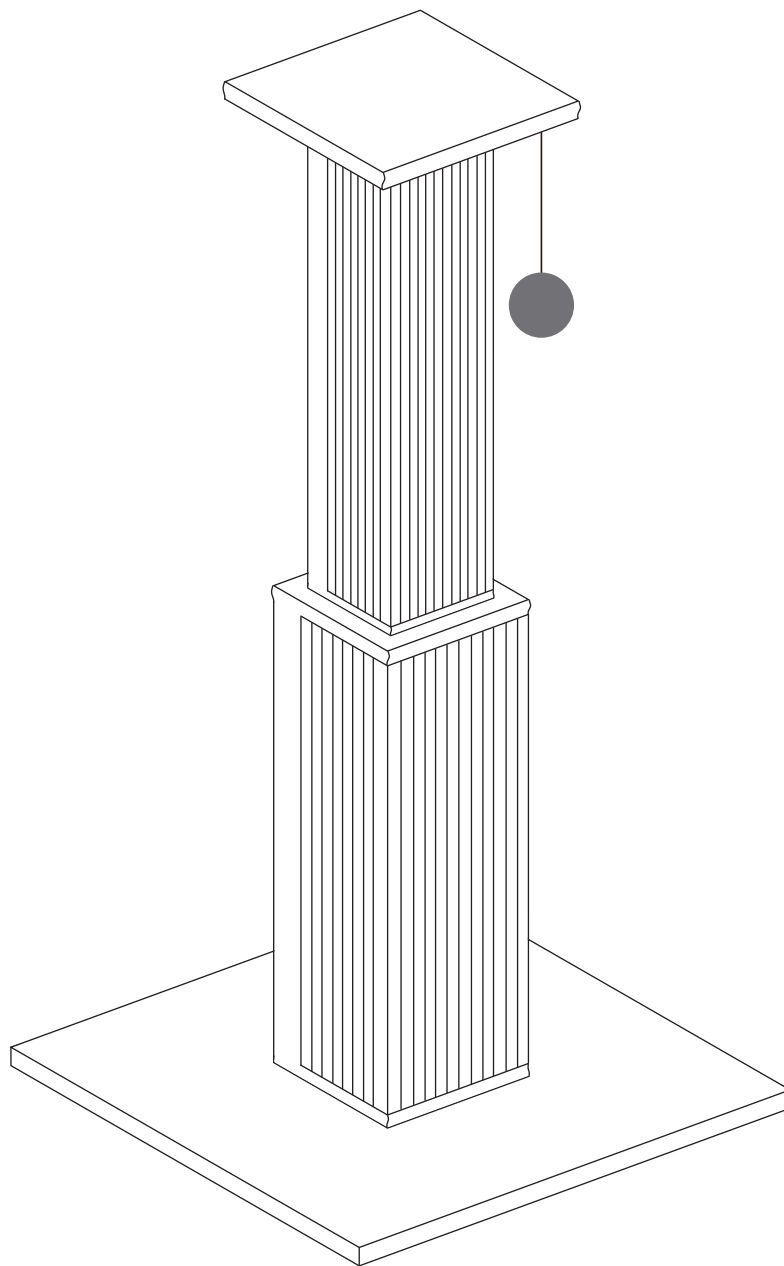

- We are committed to delivering customer-driven products that live up to your high standards.
- We encourage you to write a review sharing your experiences with the product.
- For further services:
  - Email us for further assistance.

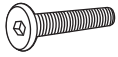

W1 : 8x60mm(5pcs)

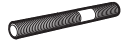

W2 : 8x62mm(1pc)



5mm(1pc)

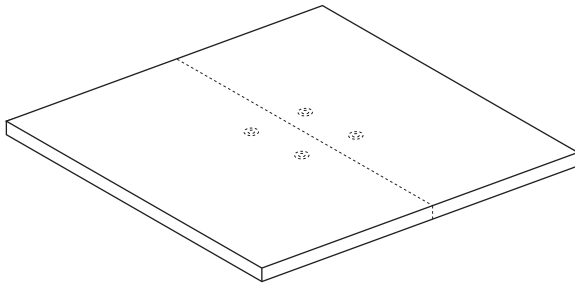

**A** 370\*370\*15mm(1pc)

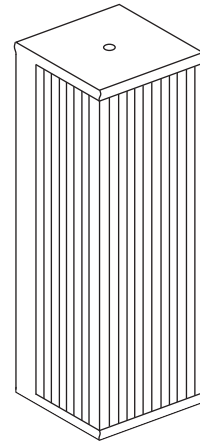

**B** 120\*120\*380mm(1pc)

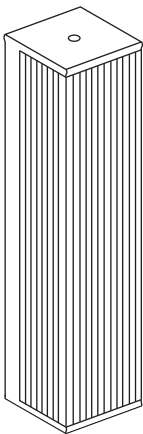

**C** 90\*90\*380mm(1pc)

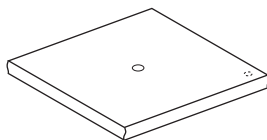

**D** 160\*160\*12mm(1pc)

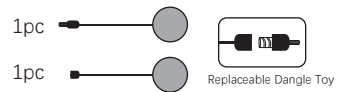

**E** 1+1(1pc)

1

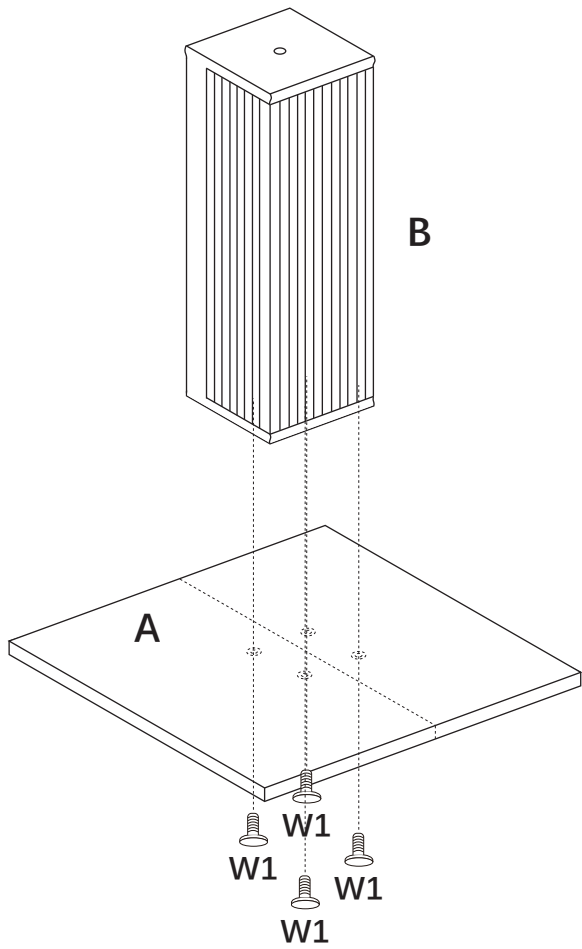

2

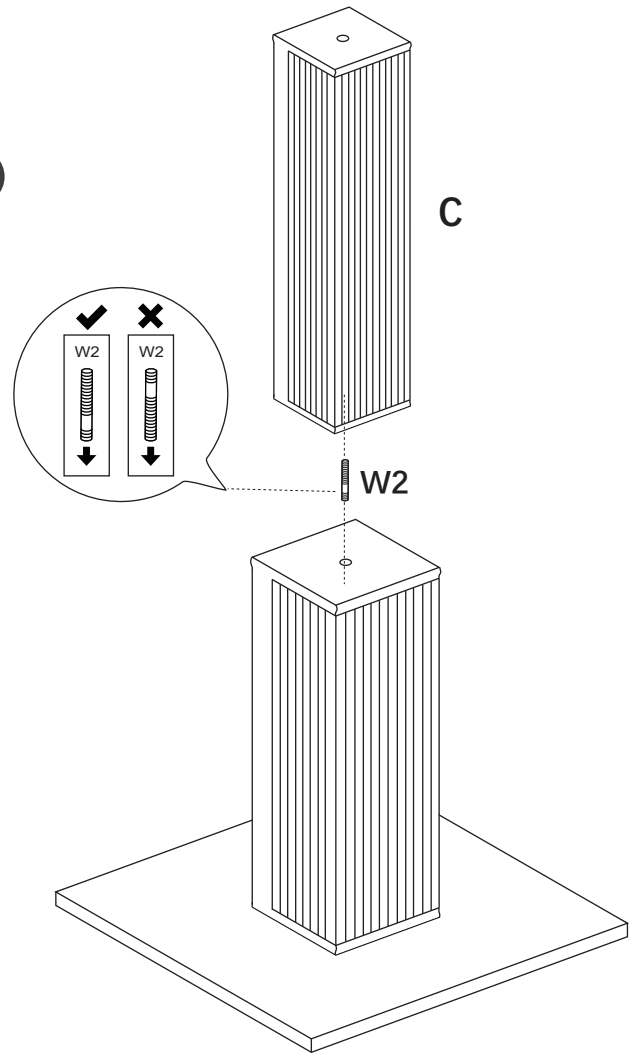

3

