

LOFT BED ASSEMBLY INSTRUCTIONS

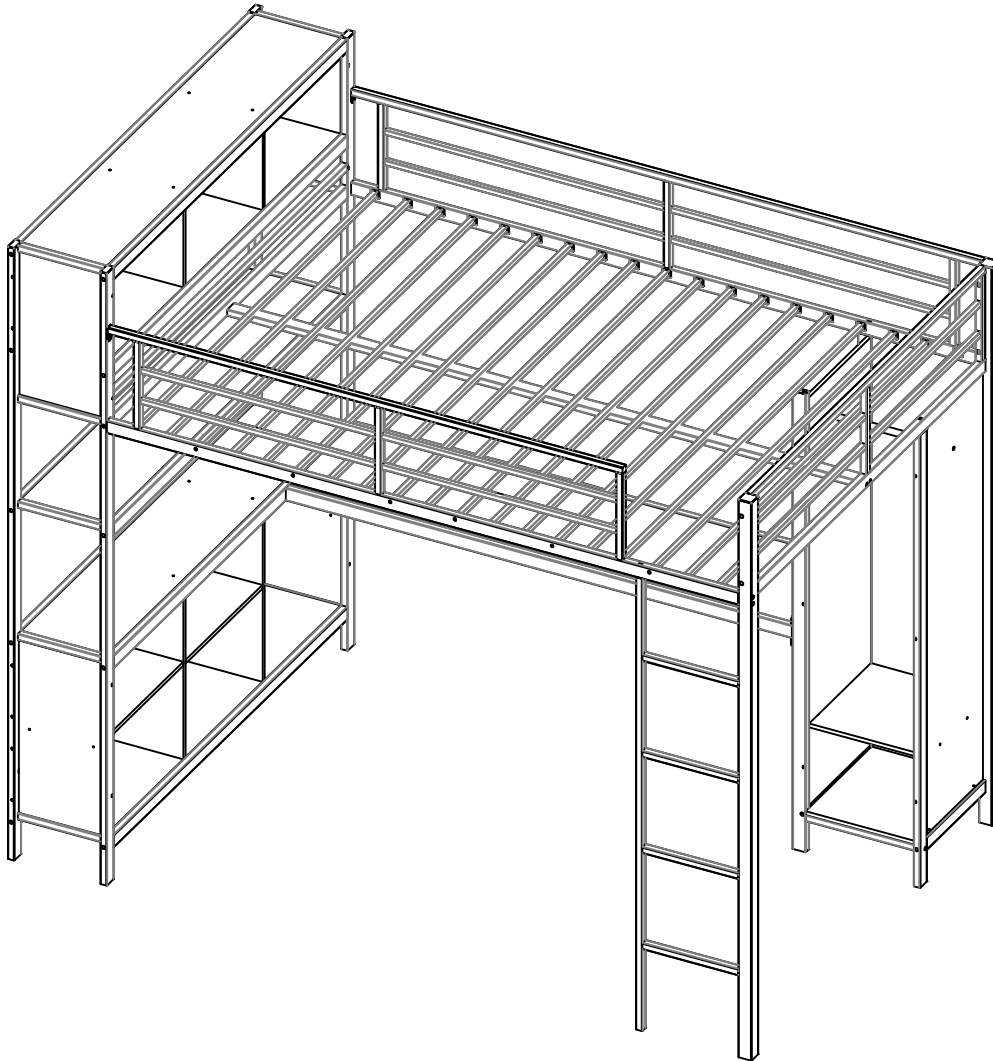

SAFETY WARNINGS AND GENERAL NOTES:

1. Follow the information on the warnings on the bunk bed end structure and on the carton. Do not remove the warning label from the bed.
2. Always use the recommended size mattress on mattress support, or both, to help prevent the likelihood of entrapment or falls.
3. Do not allow children under 6 years of age to use the upper bunk.
4. Periodically check and ensure the guardrail, ladder and other components are in their proper position, free from damage, and all connectors are tight.
5. Do not allow horseplay on or under beds.
6. Always prohibit jumping on the bed.
7. Prohibit more than one person on upper bunk.
8. Always use the ladder for entering and leaving the upper bunk.
9. Do not use substitute parts. Contact the manufacturer or dealer for replacement parts.
10. Use of a night-tight may provide added safety precaution for a child using the upper bunk.
11. Always use guardrails on both long sides of the upper bunk.
12. If the bunk bed will be placed next to a wall, the guardrail that runs the full length of the bed should be placed against the wall to prevent entrapment between the bed and the wall. The use of water or sleep flotation mattresses is prohibited.
13. **STRANGULATION HAZARD**-Never attach or hang items to any part of the bed that are not designed for use with the bed; for example, but not limited to, hooks, belts and jump ropes.
14. Keep these instructions for future reference.
15. We recommend assembling your bunk bed on the shipping carton to protect your floor or carpet.
16. Be certain all staples are out of the box before beginning assembly on the shipping carton.
17. **USE ONLY MATTRESSES WHICH ARE AS THE TABLE BELOW ON UPPER AND ON LOWER BUNKS.**

Up bed (bunk bed and tribed included)

Mattress size	Length	Width	Thickness
Queen Standard	79"-80"	59"-60"	6"max

18. SURFACE OF MATTRESS MUST BE AT LEAST 5"(127MM) BELOW THE UPPER EDGE OF GUARDRAILS.

19. Replacement Parts:

Replacement Parts, including additional guardrails, may be obtained from any of our dealers.







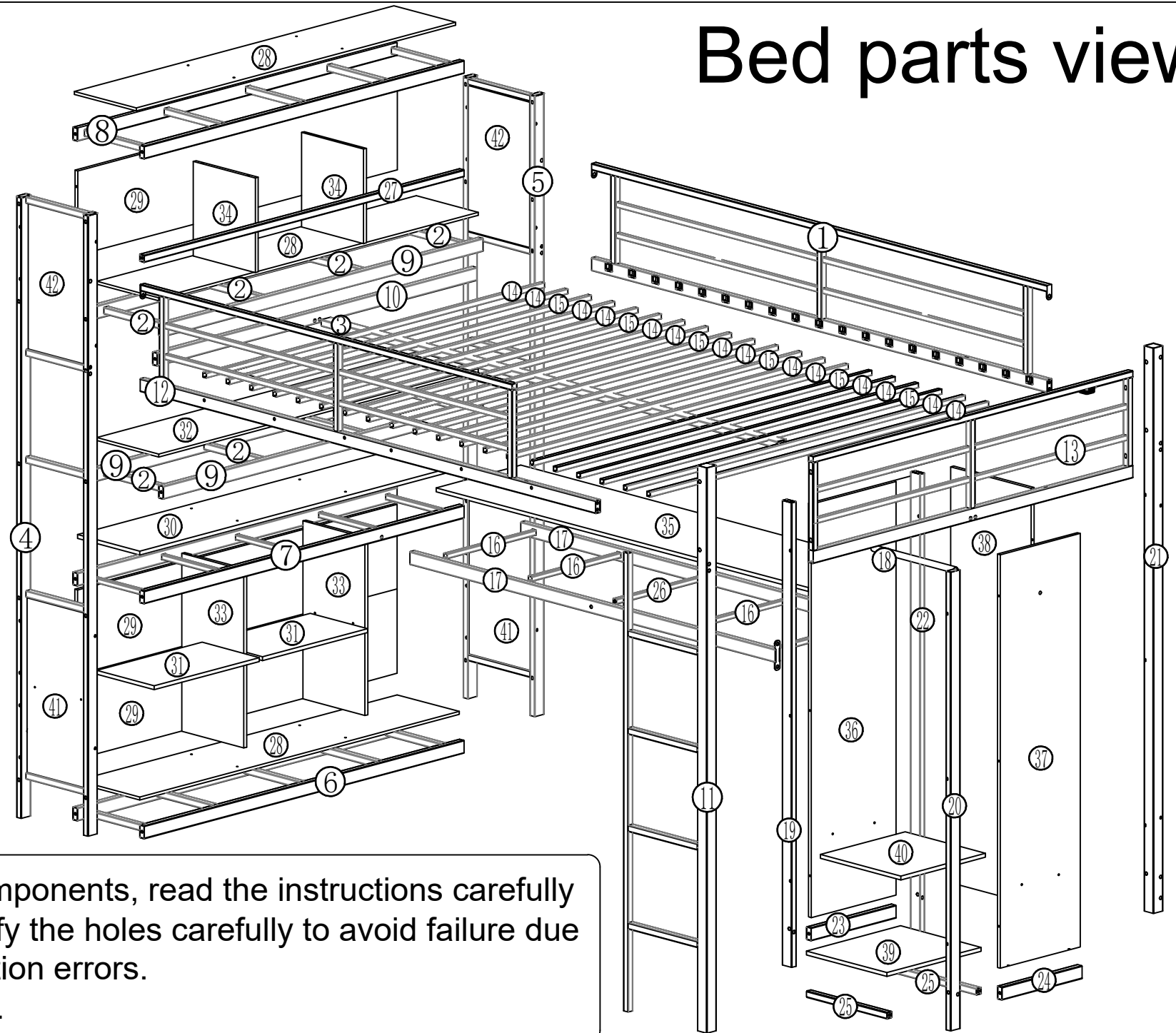





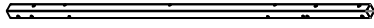



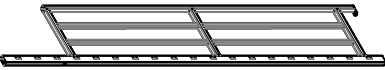

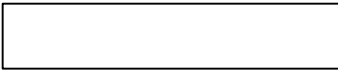



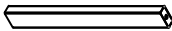
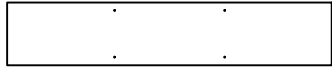



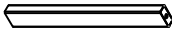







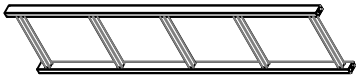

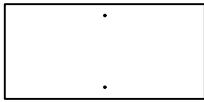
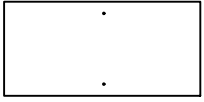
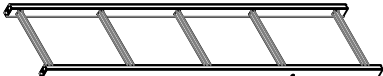



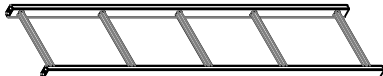
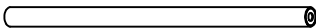





























Please use the screws according to the instructions, thank you.

Bed parts view

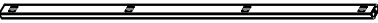
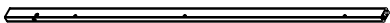

For all components, read the instructions carefully and identify the holes carefully to avoid failure due to installation errors.
thank you.



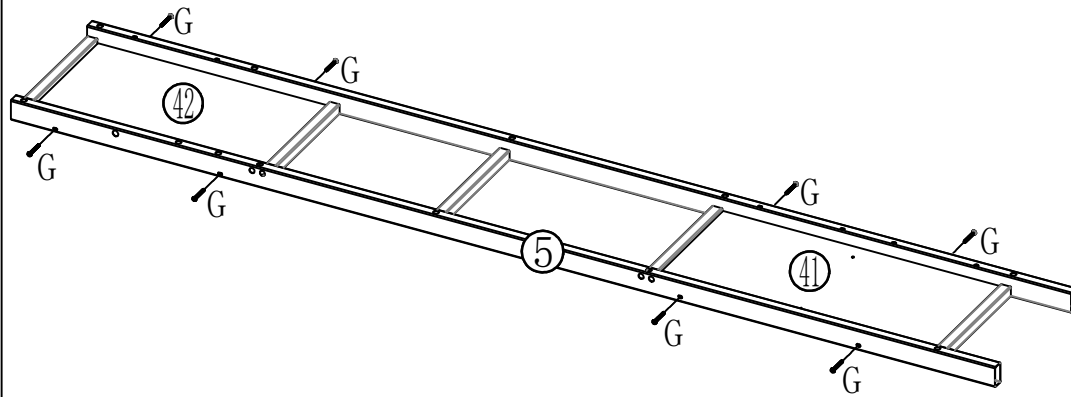

 1-1pcs	 11-1pcs	 21-1pcs	 28-3pcs	 35-1pcs																
 2-8pcs	 12-1pcs	 22-1pcs	 29-3pcs	 36-1pcs																
 3-1pcs	 13-1pcs	 23-1pcs	 30-1pcs	 37-1pcs																
 4-1pcs	 14-14pcs	 24-1pcs	 31-2pcs	 38-1pcs																
 5-1pcs	 15-6pcs	 25-2pcs	 32-1pcs	 39-1pcs	 40-1pcs															
 6-1pcs	 16-4pcs	 26-1pcs	 33-2pcs	 41-2pcs																
 7-1pcs	 17-2pcs	 27-1pcs	 34-2pcs	 42-2pcs																
 8-1pcs	 18-1pcs	<h3 style="text-align: center;">Part List</h3> <table border="1" style="width: 100%; text-align: center;"> <tbody> <tr> <td> B 8*15 6PCS</td> <td> C 8*35 17PCS</td> <td> D 8*55 40PCS</td> <td> E 6*30 20PCS</td> <td> F 7PCS</td> <td> H 4*50 22PCS</td> <td> O 1PCS</td> <td> L</td> </tr> <tr> <td></td> <td></td> <td></td> <td></td> <td> G 4*35 38PCS</td> <td> M</td> <td> K 40pcs</td> <td> J 5*10 12PCS</td> </tr> </tbody> </table>			 B 8*15 6PCS	 C 8*35 17PCS	 D 8*55 40PCS	 E 6*30 20PCS	 F 7PCS	 H 4*50 22PCS	 O 1PCS	 L					 G 4*35 38PCS	 M	 K 40pcs	 J 5*10 12PCS
 B 8*15 6PCS	 C 8*35 17PCS				 D 8*55 40PCS	 E 6*30 20PCS	 F 7PCS	 H 4*50 22PCS	 O 1PCS	 L										
							 G 4*35 38PCS	 M	 K 40pcs	 J 5*10 12PCS										
 9-4pcs	 19-1pcs																			
 10-1pcs	 20-1pcs																			

Step 1: Use hardware M,G to connect #5, #41 and #42 together.

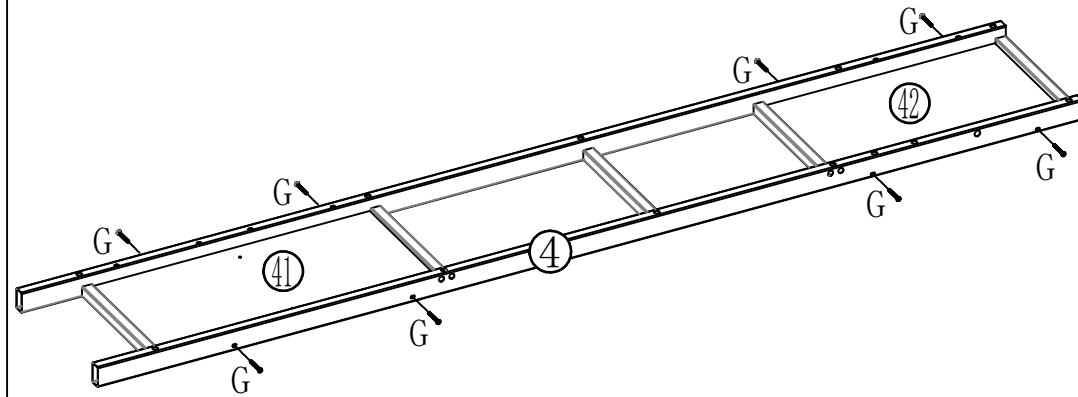

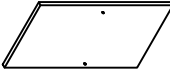
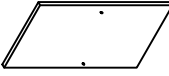
Step 2: Use hardware M,G to connect #4, #41 and #42 together.

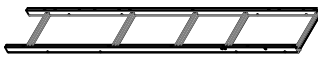
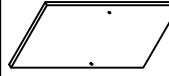
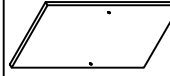

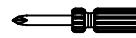
 <p>5-1PCS</p>	 <p>41-1PCS</p>	 <p>42-1PCS</p>	 <p>G M4*25-8PCS</p>	 <p>M</p>	 <p>4-1PCS</p>	 <p>41-1PCS</p>	 <p>42-1PCS</p>	 <p>G M4*25-8PCS</p>	 <p>M</p>
--	--	--	---	---	---	--	--	---	--

Step 3: Use hardware L and D to connect #2,#4,#5,#6,
#7,#8,#9,#10 and #27 to the previously installed
components.

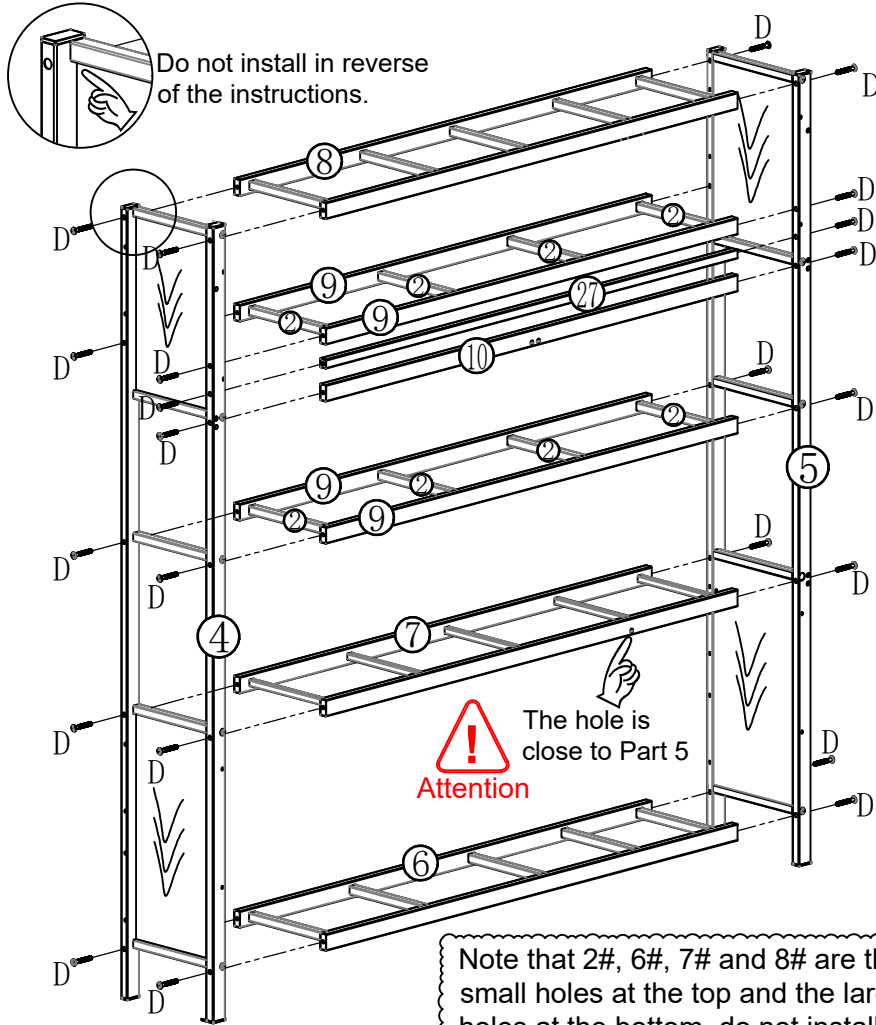

Step 4: Use hardware M,O, connect #28,#30 and #32
to the previously installed components.

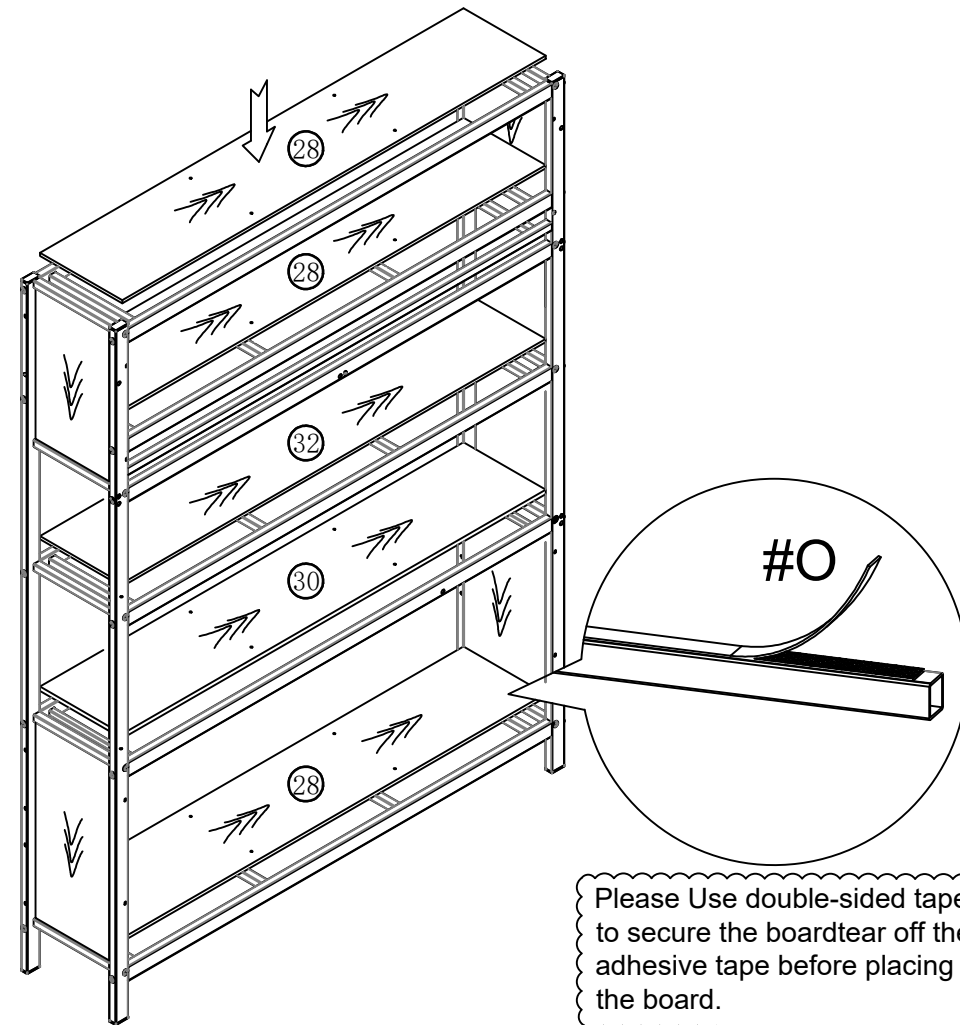

4-1pcs	7-1pcs	8-1pcs	8*55-24PCS
5-1pcs	6-1pcs	9-4pcs	
10-1pcs	27-1pcs	2-8pcs	

28-3pcs	30-1pcs	0 1PCS
32-1pcs		

Step 5: Use hardware M,G to connect #33 and #34 to the previously installed components.

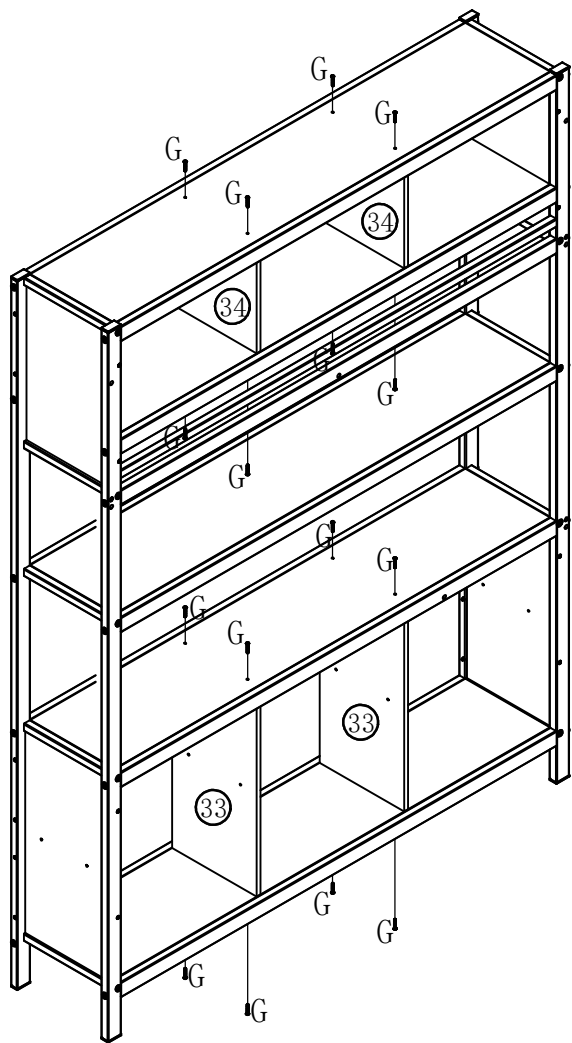

Step 6: Use hardware M,H to connect #29 to the previously installed components.

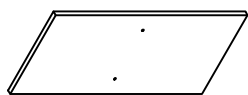
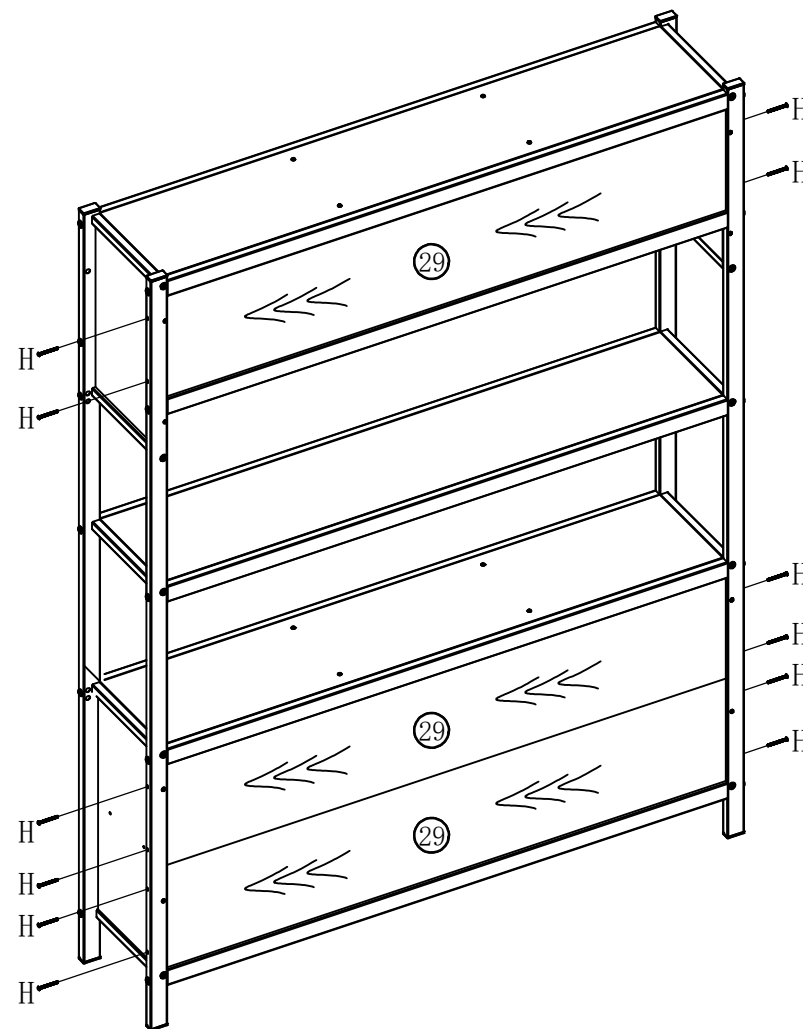

33-2pcs

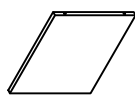

34-2pcs



G

4*35-16PCS



M

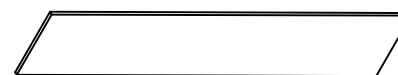

29-3pcs



H

4*50-12PCS



M

Step 7: Use hardware L,M,C,D,H,G to connect #19 ,#20, #21,#22,#23,#24,#36 and #37 to the previously installed components.(Don't get the direction wrong)

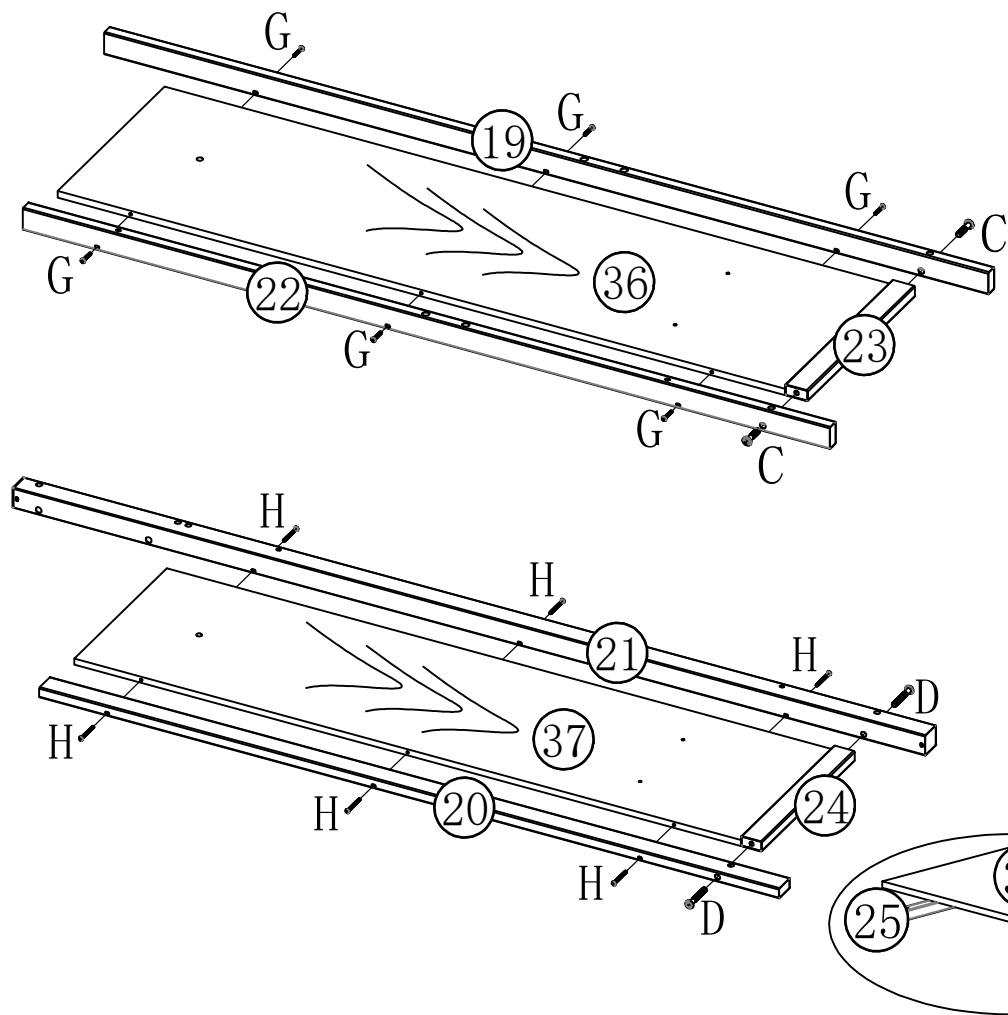

Step 8: Use hardware L,O,M,C,D,H to connect #18,#25, #38,#39 to the previously installed components.(Don't get the direction wrong)

First:

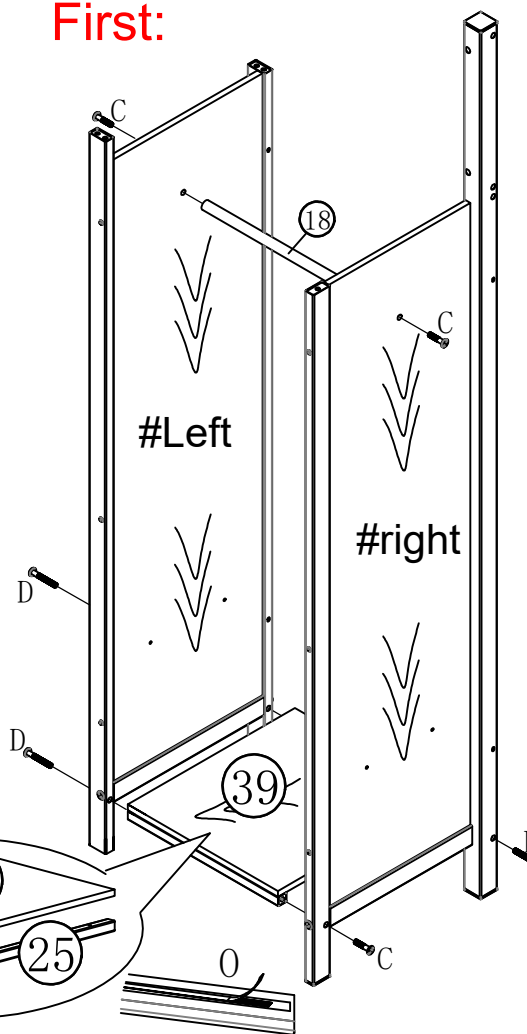

Then (back):

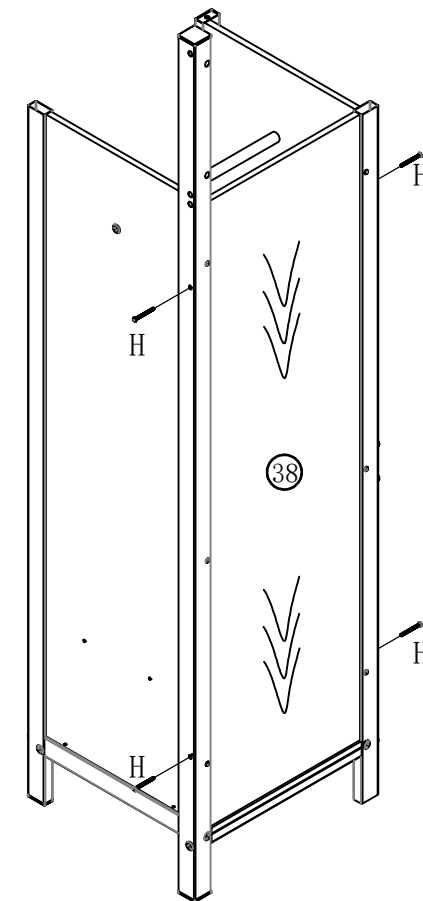





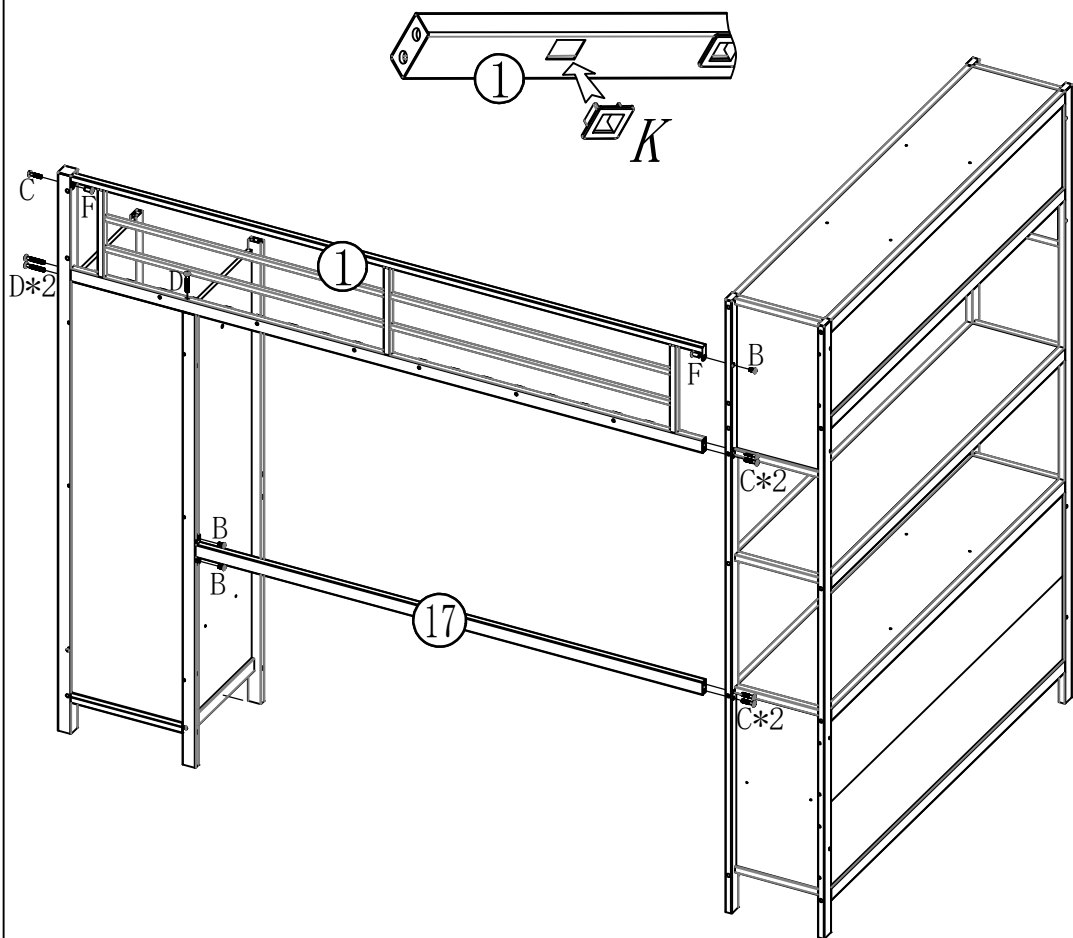

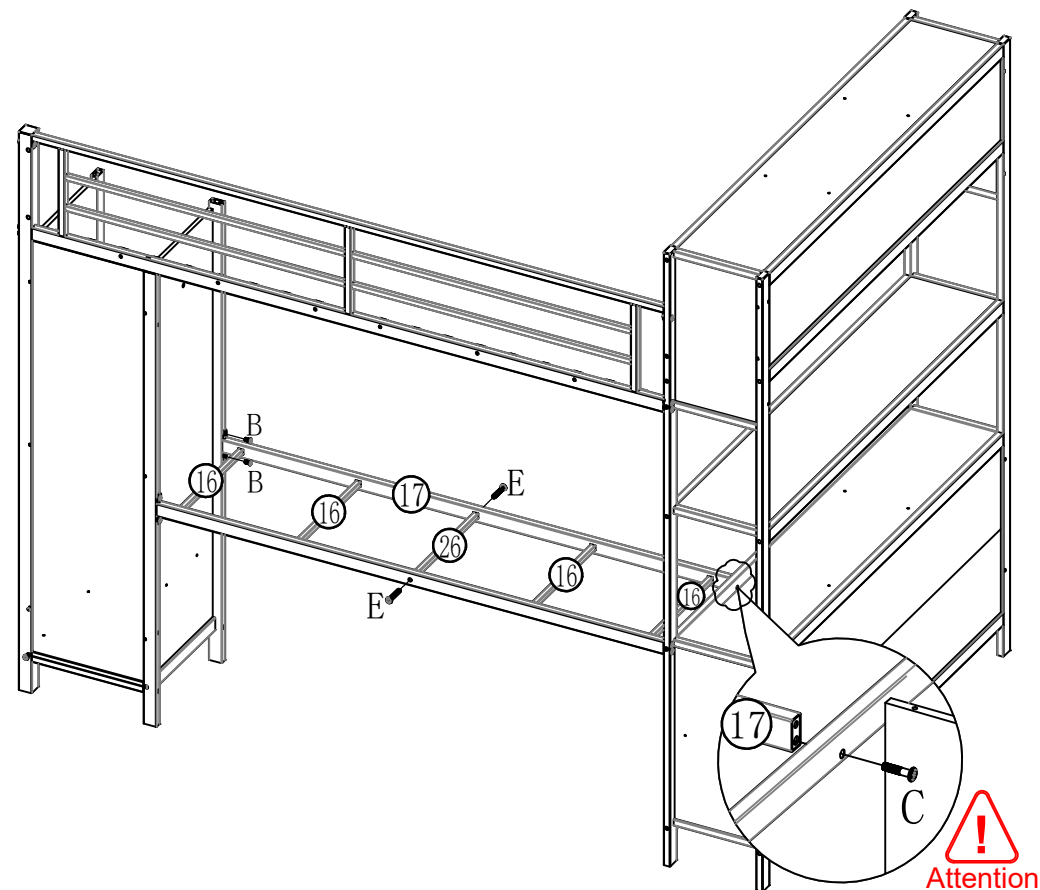

19-1pcs	21-1pcs	23-1pcs	C 8*35-2PCS	D 8*55-2PCS	M	18-1pcs	25-2pcs	O 1PCS	C 8*35 3PCS	D 8*55 3PCS	H 4*50 4PCS	M	L
22-1pcs	20-1pcs	24-1pcs	G 4*35-6PCS	H 4*50-6PCS	L	38-1pcs	39-1pcs						
36-1pcs	37-1pcs												





Step 9: Install part #K to parts #1. then Use hardware L,B,C,D,F to connect #1and #17 to the previously installed components.



Step 10: Use hardware L,B,C,E to connect #16,#17 and #26 to the previously installed components.

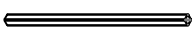

 1-1pcs	 20PCS	 8*15-3PCS	 8*55-3PCS	
 17-1pcs		 8*35-5PCS	 8*15-2PCS	

 17-1cs	 8*15 2PCS	 8*35 1PCS	 6*255 2PCS	
 16-4pcs				

Step 11: Use hardware M,A to connect #35 to the previously installed components.

Please Use double-sided tape to secure the board tear off the adhesive tape before placing the board.

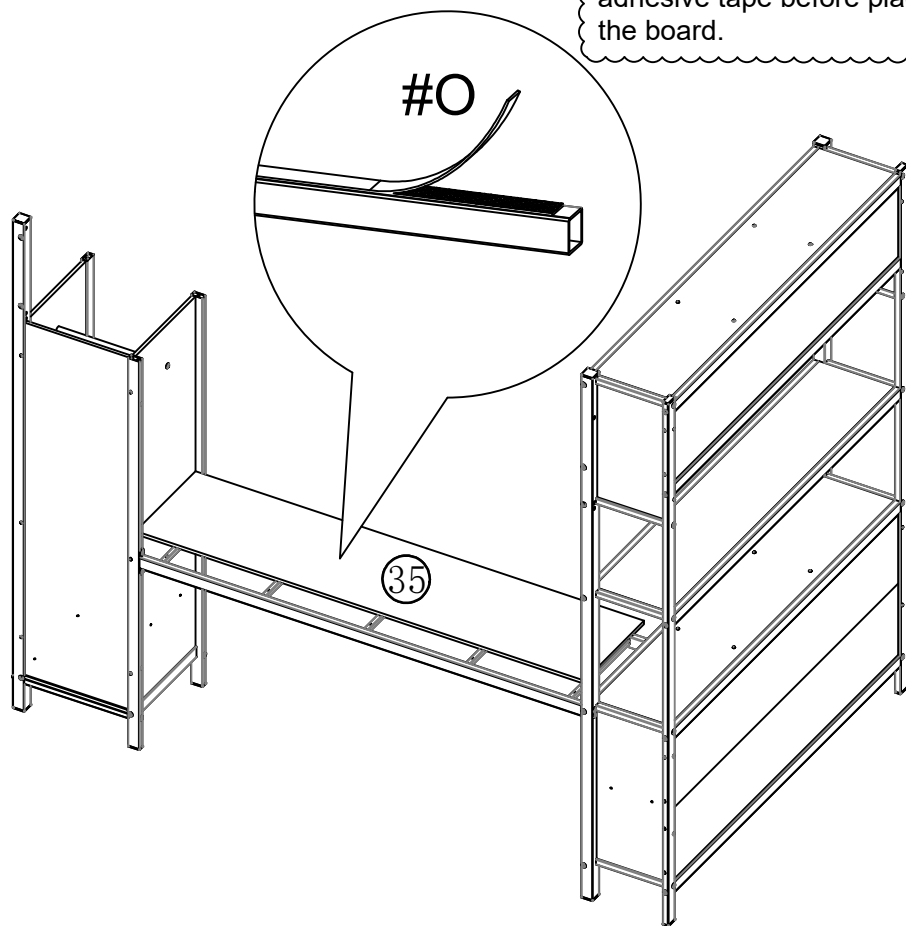

Step 12: Use hardware L,D ,F to connect #11 and #13 to the previously installed components.

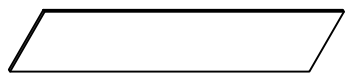
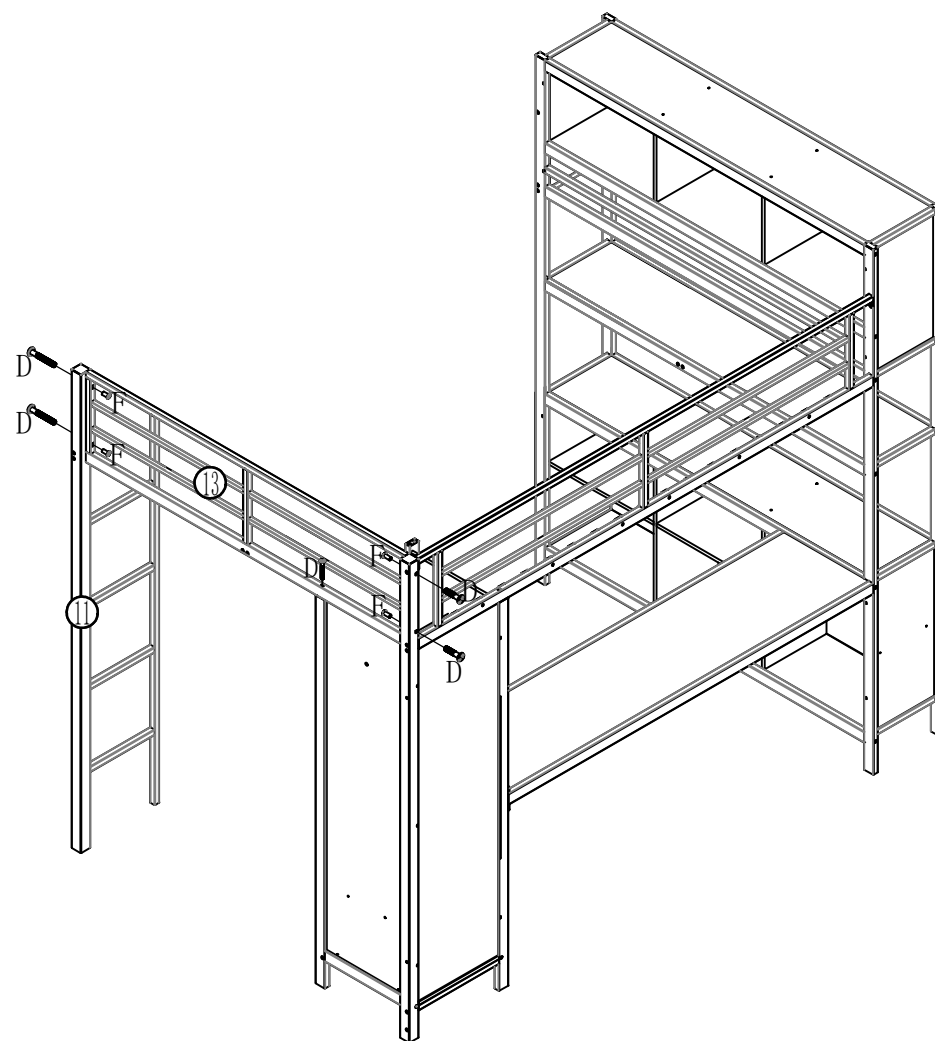

35-1pcs



1PCS



M



13-1pcs



11-1pcs

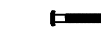

D
8*55-5PCS

F
8*15-4PCS



L

Step13: Use hardware L,C to connect #3 to the previously installed components.

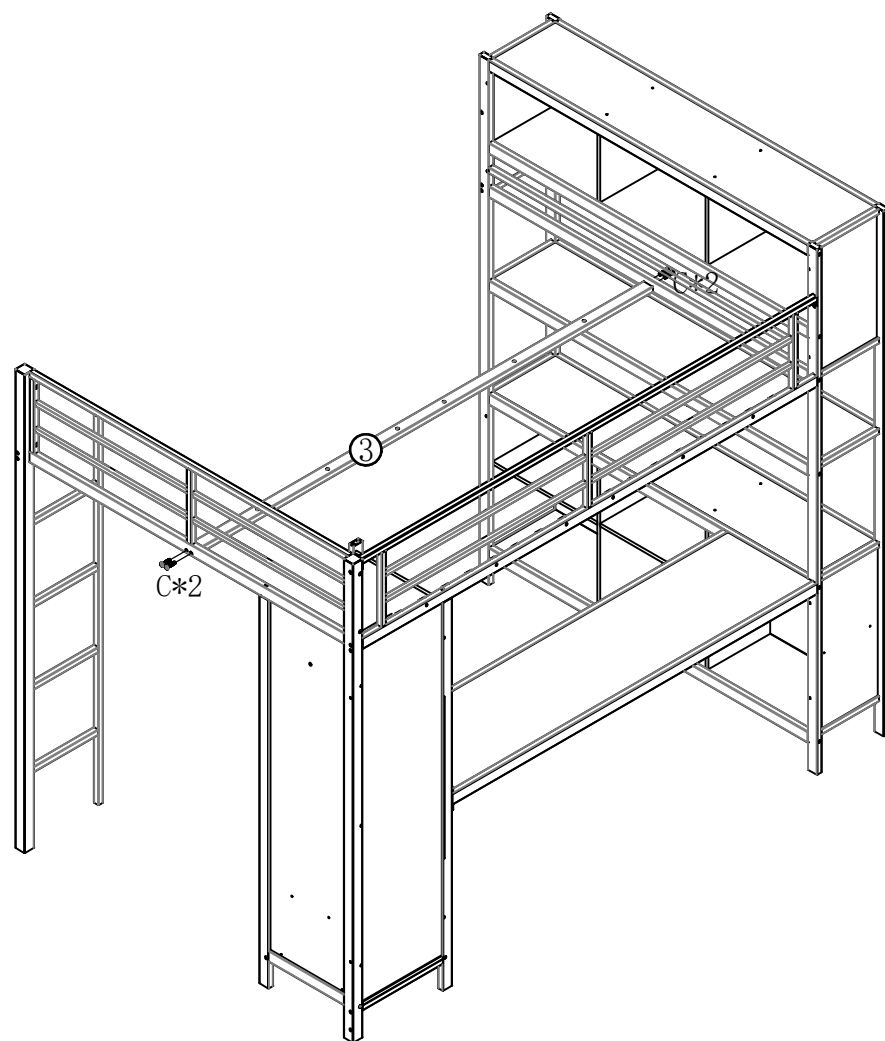

Step14: Use hardware L,C,E to connect #15 to the previously installed components.

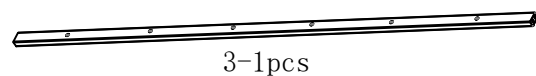
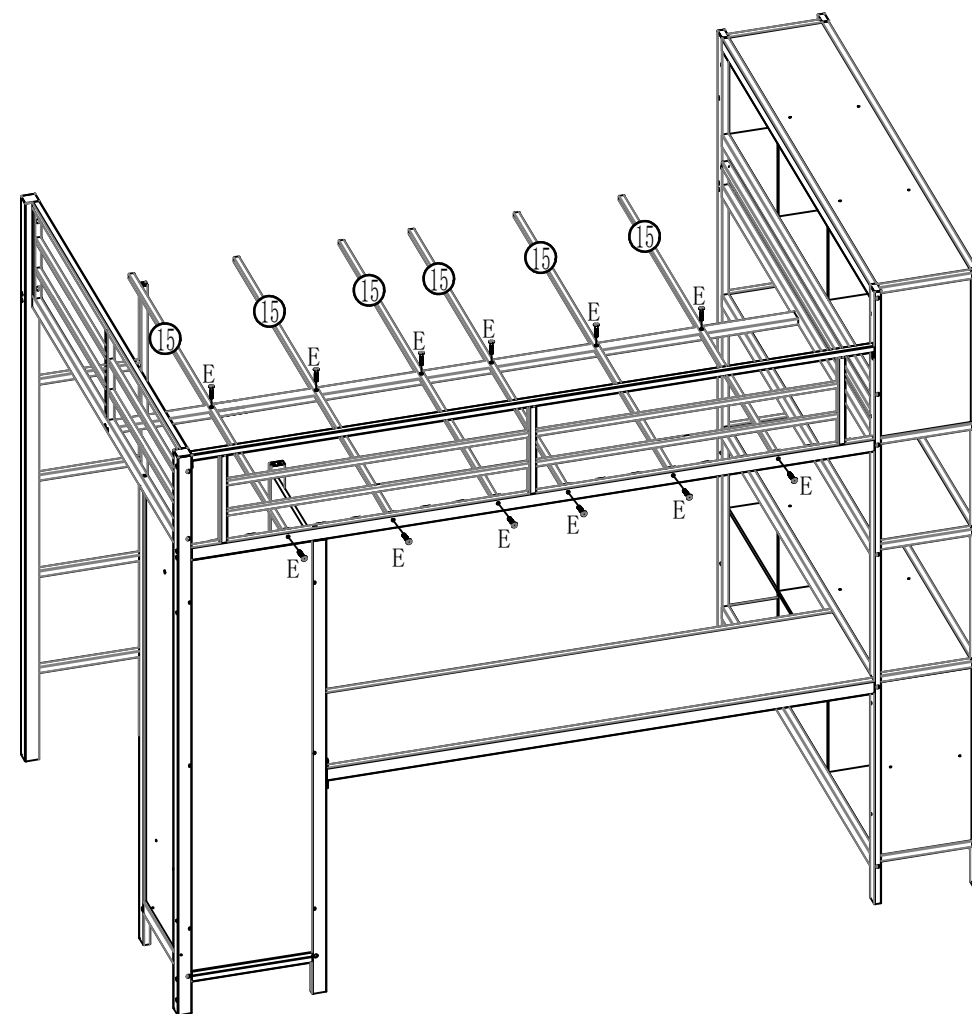

3-1pcs



C

8*35-4PCS



L



15-6pcs



C

8*35-1PCS



E

6*30-12PCS



L

Step 15: Connect #14 to the previously installed components.

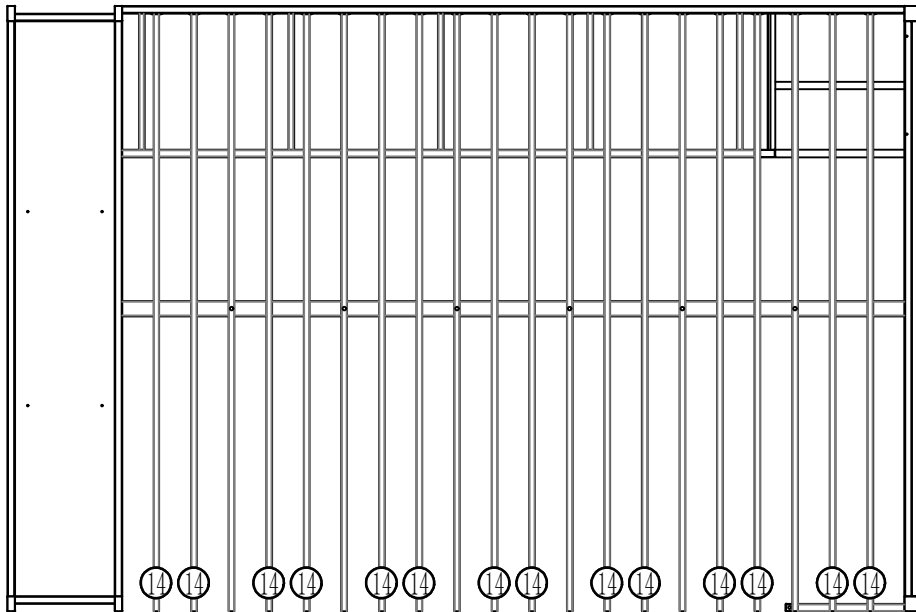

14-14pcs

Step 16: Install part #K to parts #12. Then use hardware L,C,D,E,F to connect #12 to the previously installed components.

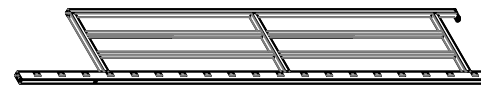
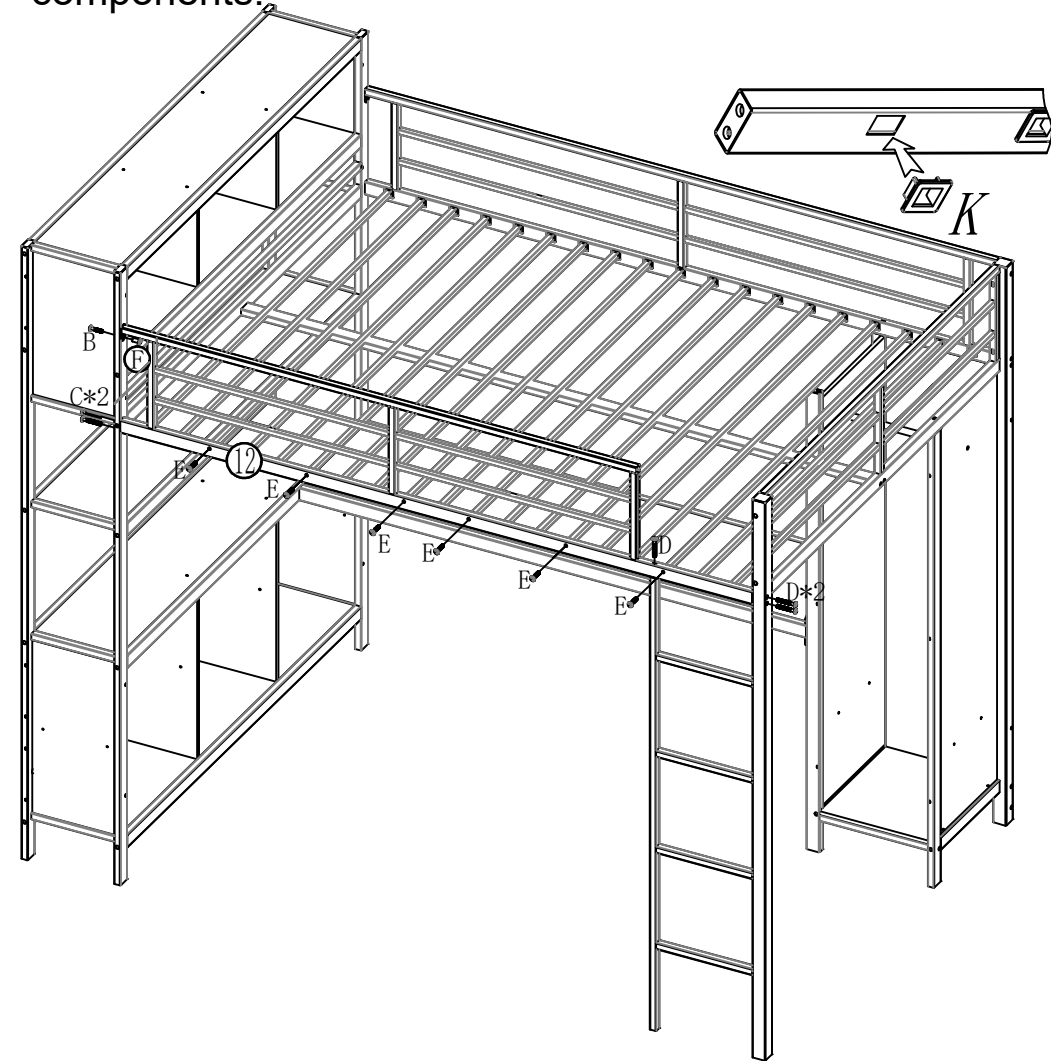

12-1pcs



K-20PCS

	F 8*15-1PCS		D 8*55-3PCS
	C 8*35-2PCS		B 8*15-1PCS
	L		E 6*30-6PCS

Step17: Use hardware J to connect #31 and #40 to the previously installed components.

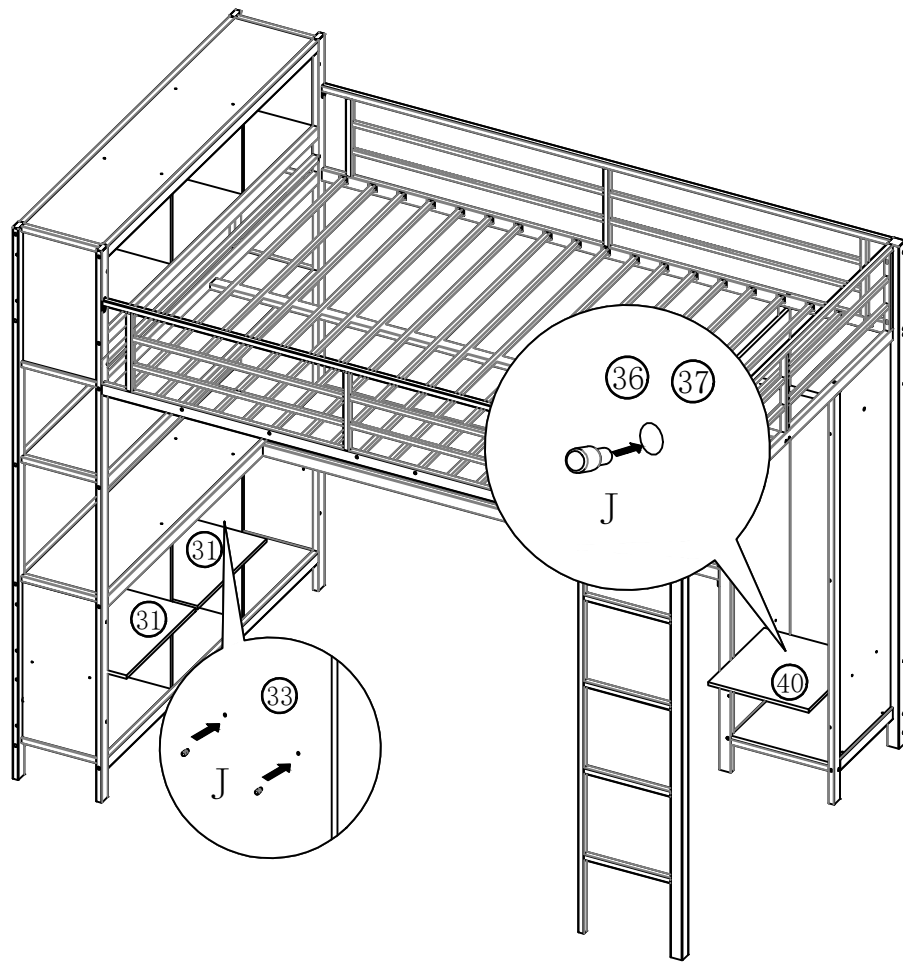

Completed

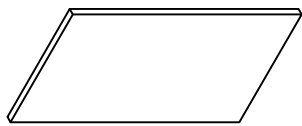
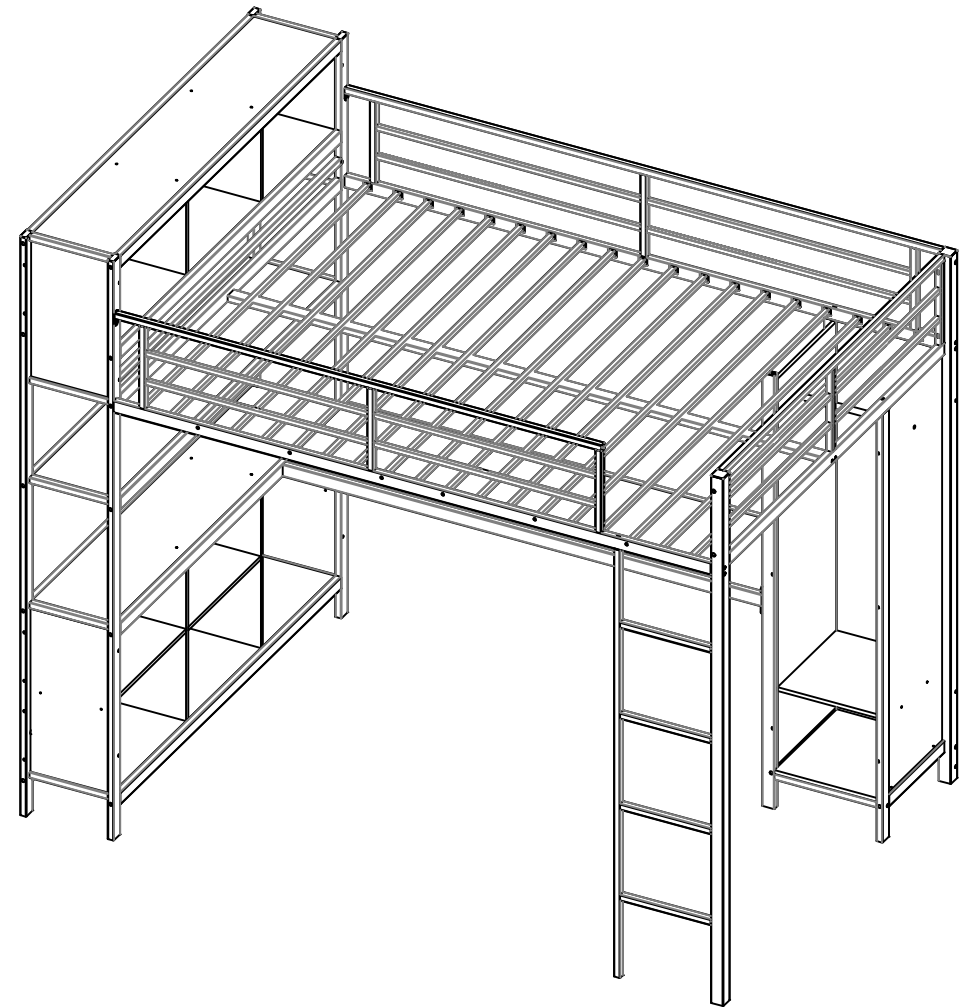

31-2pcs

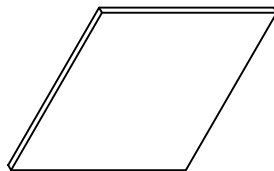

40-1pcs

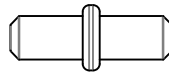

J

5*10-12PCS

Please tighten all screws before use, thank you.