













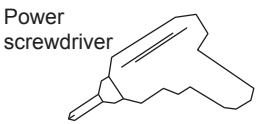
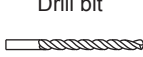

# Plastic Address Plaque (Model 3460) Instructions

Thank you for purchasing this premium mailbox accessory item. We know you'll be satisfied with the years of service it will provide. If you have any questions about how to mount or use this plaque, or if you need any replacement parts, please call us directly at (310) 374-5700 or contact us at [support@architecturalmailboxes.com](mailto:support@architecturalmailboxes.com).

Tools (not included)		Contents			
 Wrench	 Screwdriver	 cap nuts (x2)	 small hex bolts (x2)	 plastic adapters (x10)	 adhesive squares (x2)
 Power screwdriver	 Drill bit	 hex nuts (x2)	 phillips screws (x2)	 alcohol swab packet (x1)	 adhesive numbers x74
		 rubber washers (x2)	 wood/sheet metal screws (x2)	 reflective tape (x2)	<b>Note:</b> 6 and 9 can be used interchangeably.

## 1 Types of Applications

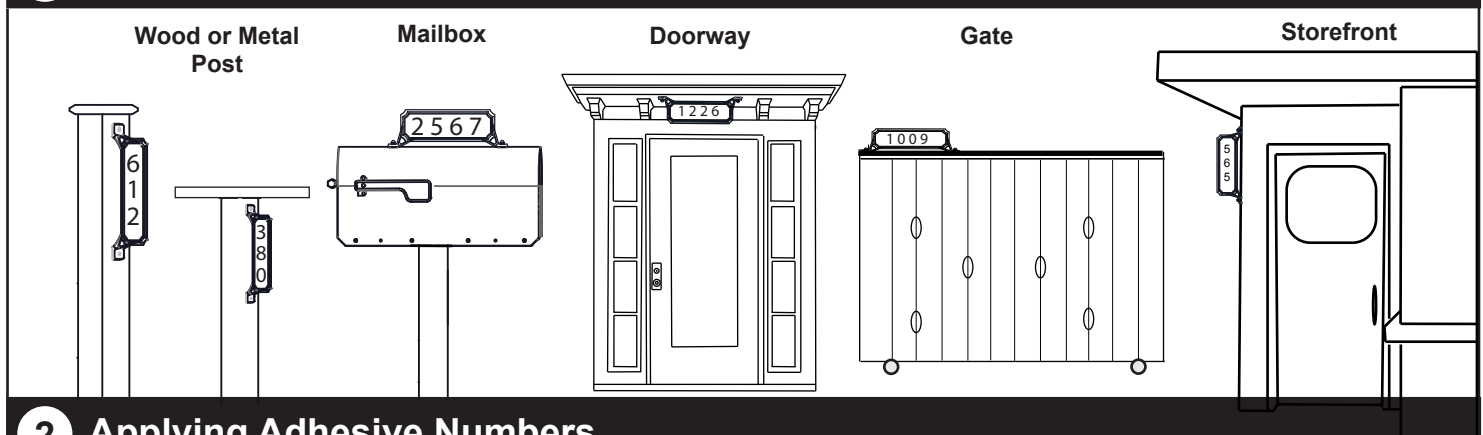

## 2 Applying Adhesive Numbers

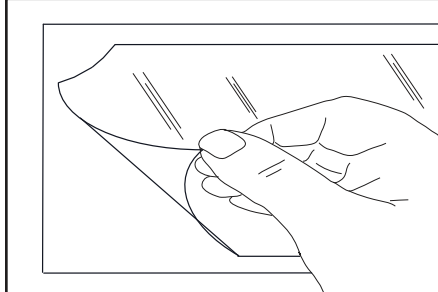
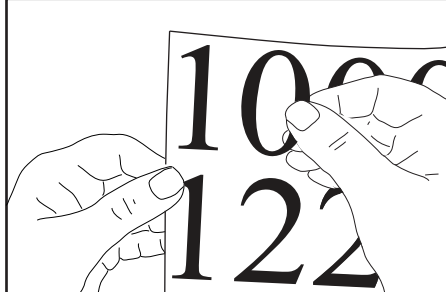
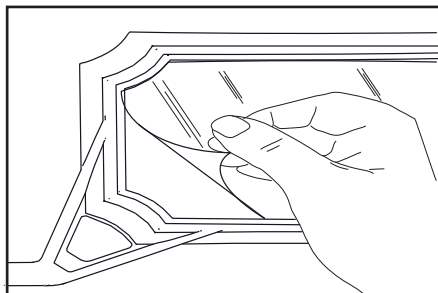
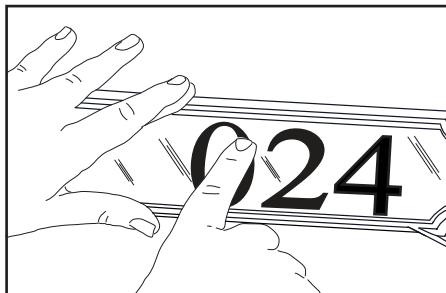
<p><b>1</b></p> <p>Peel reflective tape from backing.</p>		<p><b>3</b></p> <p>Peel numbers off the paper backing.</p>	
<p><b>2</b></p> <p>Apply reflective tape to address plaque.</p> <p>Note: If misaligned, carefully peel tape and reapply in correct location.</p>		<p><b>4</b></p> <p>Apply numbers to reflective tape.</p> <p>Note: If misaligned, carefully peel numbers and reapply in correct location.</p>	

### DIY Hint to Apply Numbers Stickers Straight and Evenly, Every Time!

Use a clear ruler and lightly stick the lower part of your number stickers onto the ruler's edge using the ruler marks as your guide to space the numbers evenly. Let the upper portion of the letters stick out the top. Set the ruler down and use your finger to press the top of each sticker down in place on the reflective tape. When all the stickers are secure, carefully remove the ruler and press the bottoms of the stickers in place with your finger.

# Plastic Address Plaque (Model 3460) Instructions

## 3 Installation Instructions

### FOR USE WITH ADHESIVE SQUARES (no drilling required - best for clean smooth surfaces like painted metal)

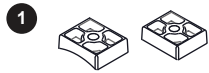

Choose correct adapters based on surface curvature.

There are 5 pairs, numbered 1 (flat) through 5 (most curved).

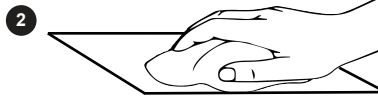

⚠ Clean desired surface with alcohol wipe.

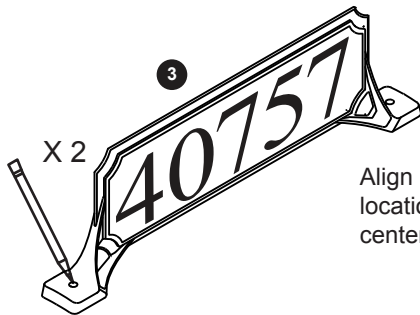

Align plaque at desired location and mark the center of each hole.

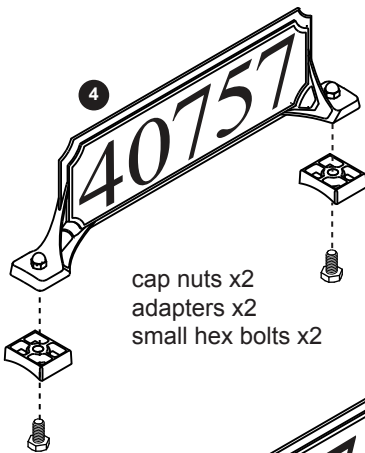

Place adapters into the feet of the plaque and secure with 2 small hex bolts and 2 cap nuts.

cap nuts x2  
adapters x2  
small hex bolts x2

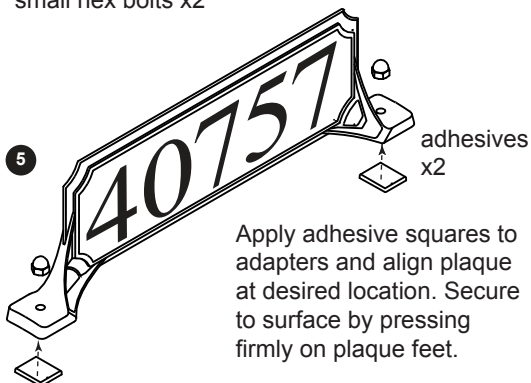

Apply adhesive squares to adapters and align plaque at desired location. Secure to surface by pressing firmly on plaque feet.

\* The Adhesive Squares use advanced 3M® VHB™ adhesive that chemically bonds to surfaces. For best results, make sure the surface is clean, and press firmly onto the surface for 30 seconds before releasing. Also note that maximum adhesion can take as long as 72 hours, so after application let them set for best results.

### FOR USE WITH SCREWS (more secure - drilling required)

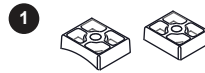

Choose correct adapter based on surface curvature.

There are 5 pairs, numbered 1 (flat) through 5 (most curved).

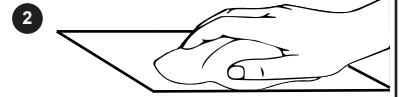

⚠ Clean desired surface with alcohol wipe.

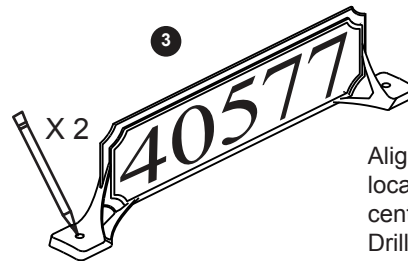

Align plaque at desired location and mark the center of each hole. Drill pilot holes if necessary (use 1/8" drill bit).

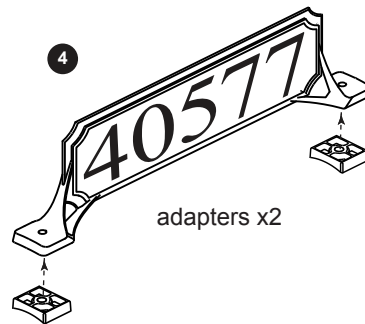

Place adapters into the feet of the plaque.

adapters x2

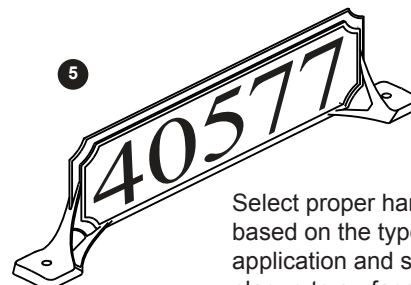

Select proper hardware based on the type of application and secure plaque to surface.



Use the wood screws for 4x4 posts or fences.



Use the long Phillips screws, washers and hex nuts for metal and other thin surfaces.