

ASSEMBLY INSTRUCTIONS (INSTRUCTIONS DE MONTAGE)

Dining chair
(Chaise à manger)

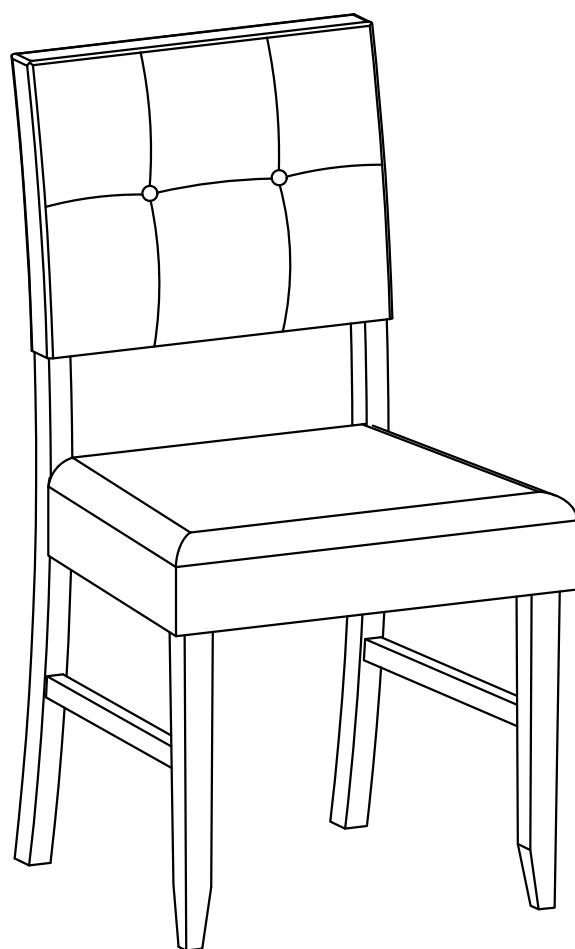

ASSEMBLY INSTRUCTIONS (INSTRUCTIONS DE MONTAGE)

Please read these instructions fully before starting assembly:
(Veuillez lire entièrement ces instructions avant de commencer
l'assemblage :)

1. Place all wooden parts on a clean and smooth surface such as a rug or carpet to avoid scratching the parts.
(Placez toutes les pièces en bois sur une surface propre et lisse telle que tapis ou moquette pour éviter de rayer les pièces.)
2. Kindly follow the assembly instructions step by step.
(Veuillez suivre les instructions de montage étape par étape.)
3. Do not tighten all screws and bolts until the table is fully assembled.
(Ne serrez pas toutes les vis et tous les boulons tant que la table n'est pas complètement assemblée.)
4. Unscrew the protective plastic supports from the metal insert of the table legs before assembly.
(Dévissez les supports de protection en plastique des supports métalliques d'insertion des pieds de table avant l'assemblage.)
5. Parts of the assembly will be easier with 2 people.
(Certaines parties du montage seront plus faciles à réaliser à 2 personnes.)

Care and maintenance:

Entretien et maintenance :

Only clean using a damp cloth and mild detergent, do not use bleach or abrasive cleaners.

Nettoyer uniquement avec un chiffon humide et un détergent doux, ne pas utiliser de l'eau de Javel ou des nettoyants abrasifs.

ASSEMBLY INSTRUCTIONS (INSTRUCTIONS DE MONTAGE)

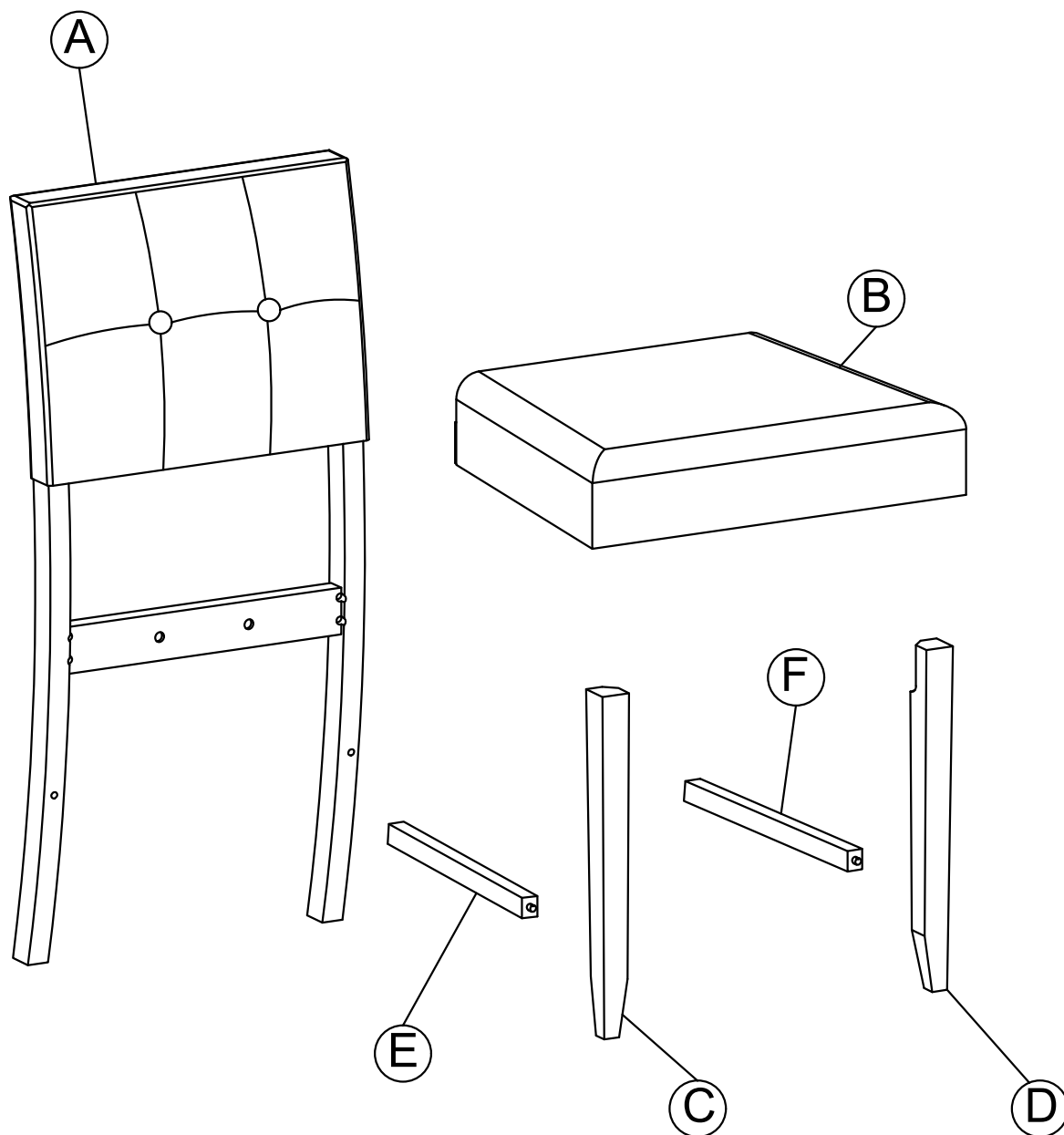

ASSEMBLY INSTRUCTIONS (INSTRUCTIONS DE MONTAGE)

Part List (LISTE DES PIÈCES)

(A)

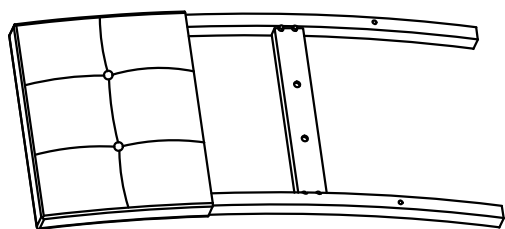

BACK FRAME (4 pcs)
(CADRE ARRIÈRE)

(B)

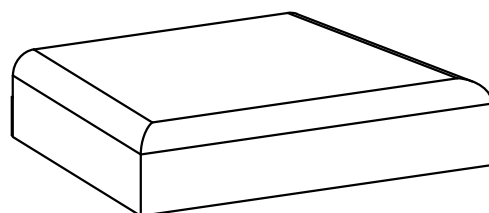

SEAT FRAME (4 pcs)
(CARE DE SIÈGE)

(C)

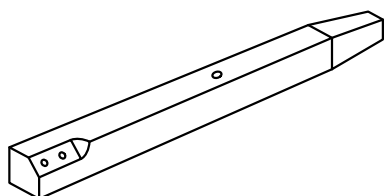

LEG LEFT (4 pcs)
(JAMBE GAUCHE)

(D)

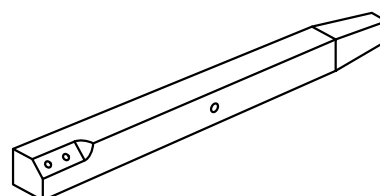

LEG RIGHT (4 pcs)
(JAMBE DROITE)

(E)

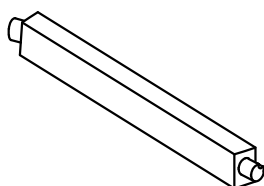

LEFT SIDE STRETCHER (4 pcs)
(CIVIÈRE CÔTÉ GAUCHE)

(F)

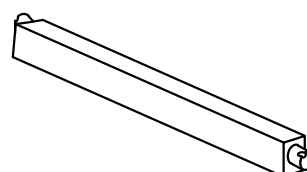

RIGHT SIDE STRETCHER (4 pcs)
(CIVIÈRE CÔTÉ DROIT)

ASSEMBLY INSTRUCTIONS (INSTRUCTIONS DE MONTAGE)

Hardware List (Liste du matériel)

①

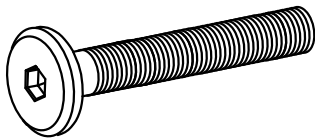

Ø1/4" x 40 mm

BOLT (8 pcs)
(BOULON)

②

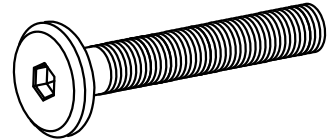

Ø1/4" x 55 mm

BOLT (16 pcs)
(BOULON)

③

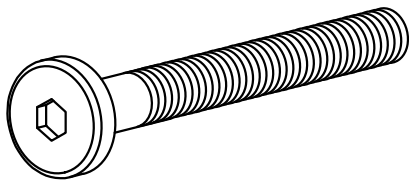

Ø1/4" x 75 mm

BOLT (16 pcs)
(BOULON)

④



Ø5/16" x 13 mm

LOCK WASHER (40 pcs)
(RONDELLE DE BLOCAGE)

⑤

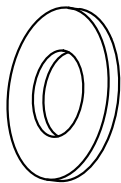

Ø5/16" x 19 x 2 mm

FLAT WASHER (40 pcs)
(RONDELLE PLATE)

⑥

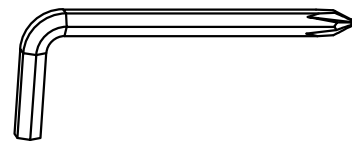

4 mm

ALLEN KEY AND PHILLIPS HEAD (1 pc)
(CLÉ ALLEN ET TÊTE CRUCIFOME)

⑦

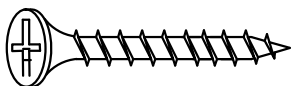

Ø4 x 38mm





WOOD SCREWS (16pcs)
(LES VIS À BOIS)

ASSEMBLY INSTRUCTIONS (INSTRUCTIONS DE MONTAGE)

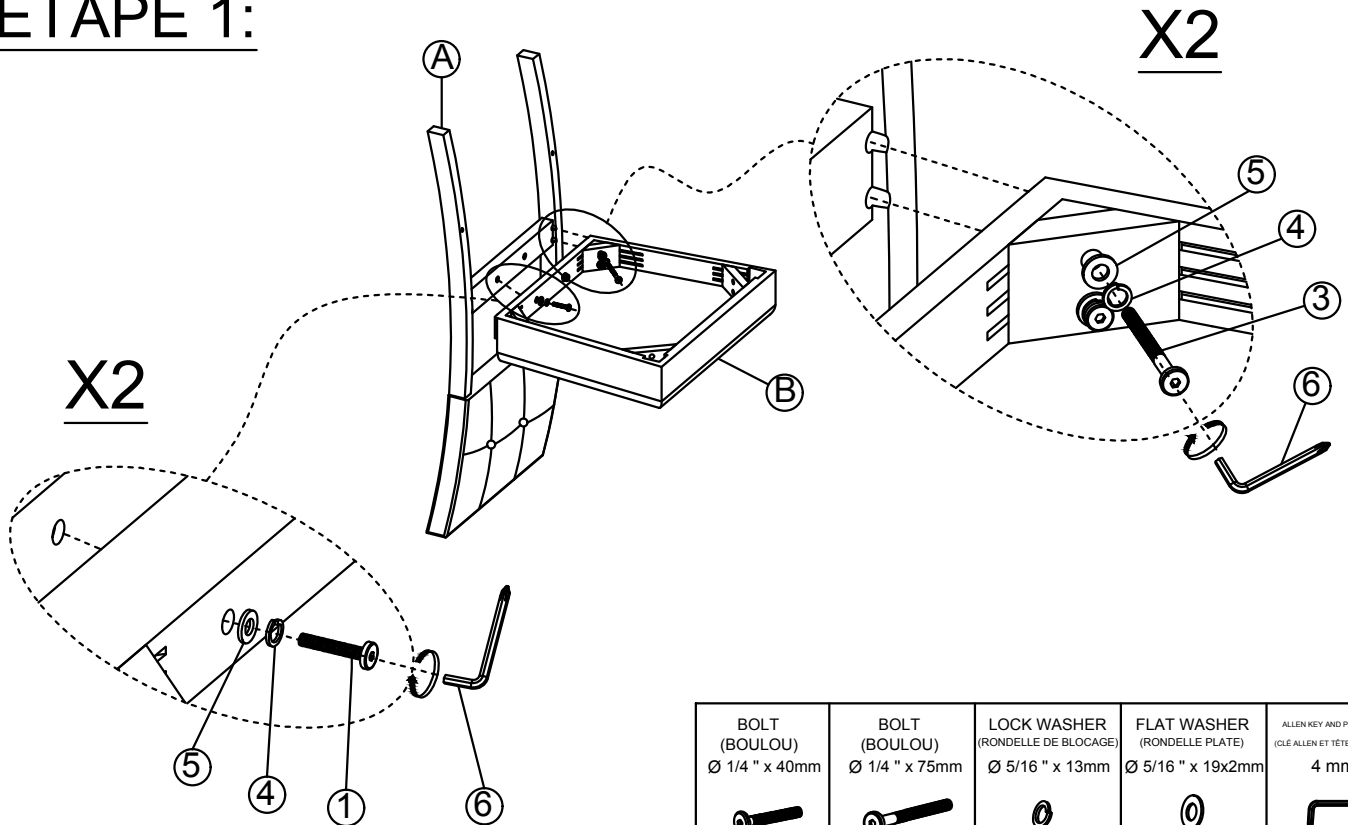
STEP 1:

ÉTAPE 1:





BOLT (BOULOU) Ø 1/4 " x 40mm  ① x 2	BOLT (BOULOU) Ø 1/4 " x 75mm  ③ x 4	LOCK WASHER (RONDELLE DE BLOCAGE) Ø 5/16 " x 13mm  ④ x 6	FLAT WASHER (RONDELLE PLATE) Ø 5/16 " x 19x2mm  ⑤ x 6	ALLEN KEY AND PHILLIPS HEAD (CLÉ ALLEN ET TÊTE CRUCIFORME) 4 mm  ⑥ x 1
---	--	--	---	--

STEP 2:

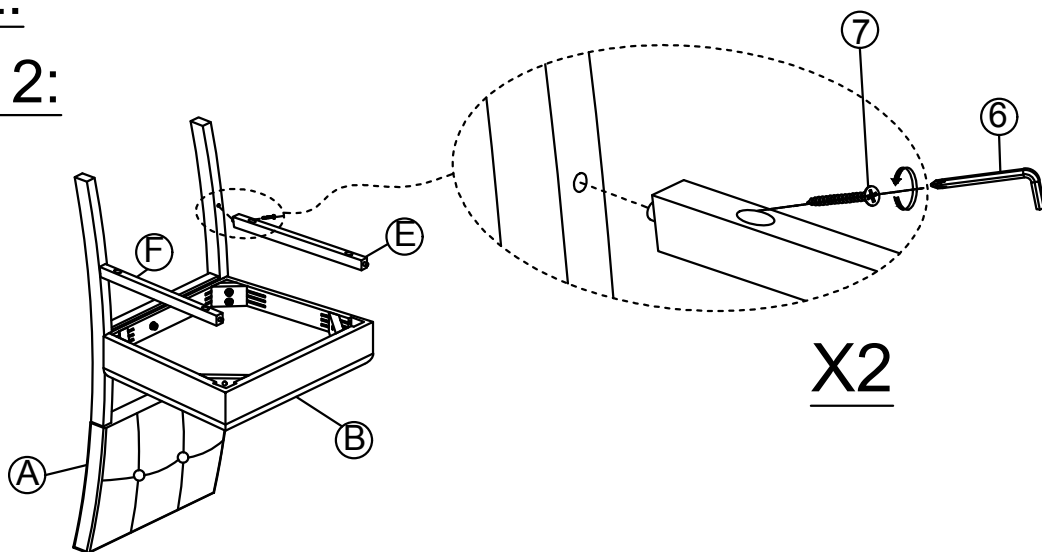
ÉTAPE 2:







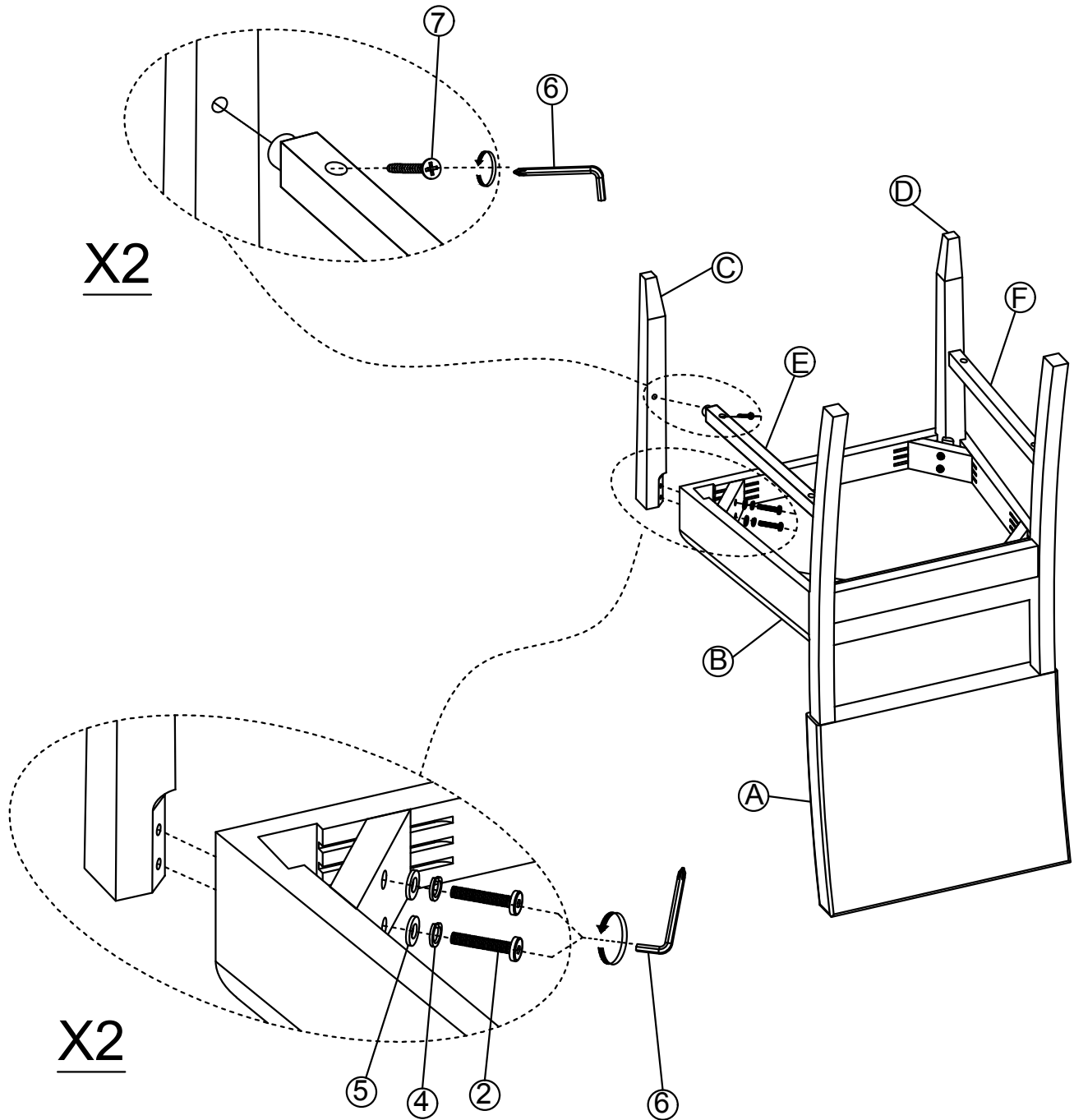

ALLEN KEY AND PHILLIPS HEAD (CLÉ ALLEN ET TÊTE CRUCIFORME) 4 mm  ⑥ x 1	WOOD SCREWS (LES VIS À BOIS) Ø 4 X 38mm  ⑦ x 2
--	--

ASSEMBLY INSTRUCTIONS (INSTRUCTIONS DE MONTAGE)

STEP 3:

ÉTAPE 3:



BOLT (BOULOU) Ø 1/4 " x 55mm	LOCK WASHER (RONDELLE DE BLOCAGE) Ø 5/16 " x 13mm	FLAT WASHER (RONDELLE PLATE) Ø 5/16 " x 19x2mm	ALLEN KEY AND PHILLIPS HEAD (CLÉ ALLEN ET TÊTE CRUCIFORME) 4 mm	WOOD SCREWS (LES VIS À BOIS)
				
② x 4	④ x 4	⑤ x 4	⑥ x 1	⑦ x 2

ASSEMBLY INSTRUCTIONS (INSTRUCTIONS DE MONTAGE)

STEP 4:

ÉTAPE 4:

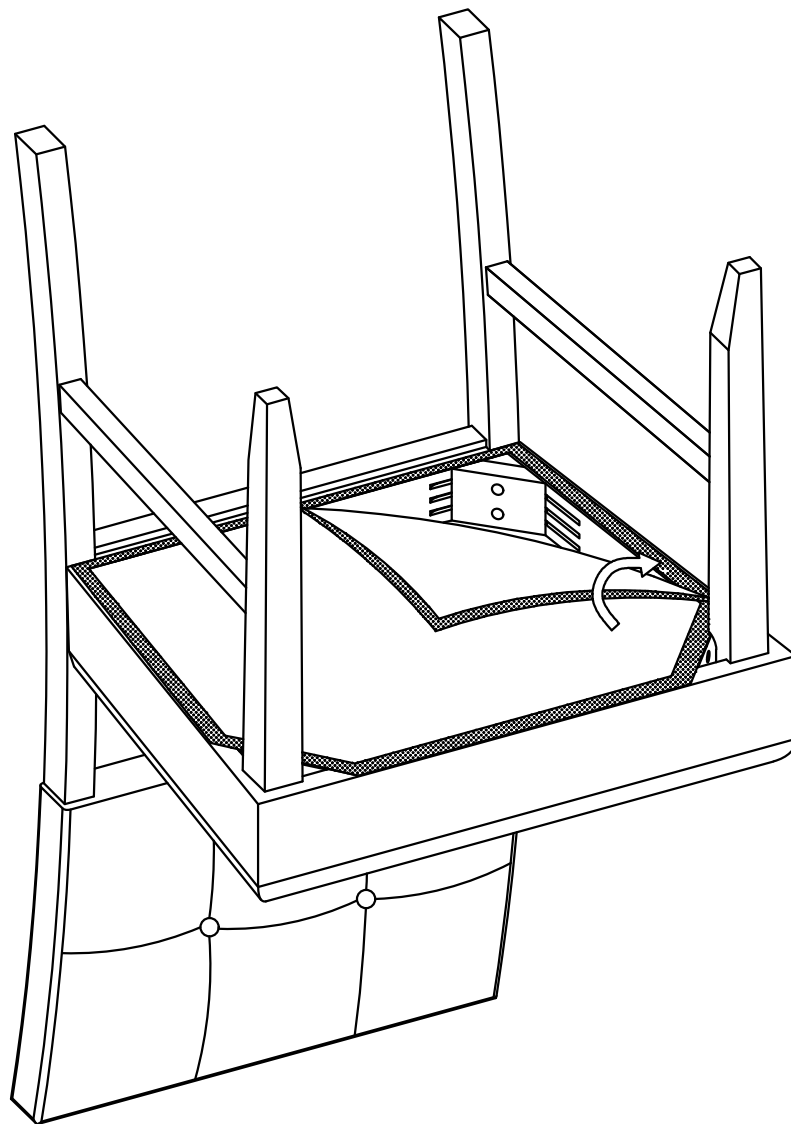

ASSEMBLY INSTRUCTIONS (INSTRUCTIONS DE MONTAGE)

COMPLETE

COMPL/ TED

