











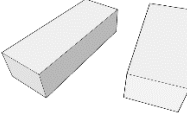

Assembly Instructions

Before you commence the assembly process we recommend that you read these instructions thoroughly beforehand to familiarise yourself with the assembly process and to also check that you have the correct components. If for any reason you need assistance, you can find our contact details on the final page of these instructions.

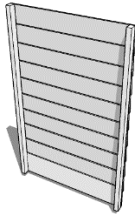
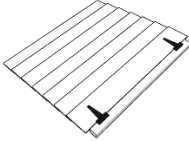
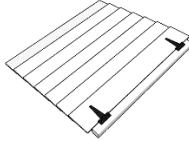
We highly recommend that any assembly is carried out on an open flat, level surface if possible with sufficient space.

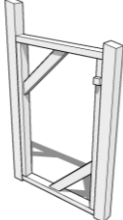
Tools required: 10mm spanner/socket, No2 Pozidriv screwdriver (or electric driver)

Components

38 x Short screws 4 x Long screws	3 x Latch keep & 48 black screws	3 x Prop fixing	2 x Spacer blocks	3 x Metal bar	3 x Chain
					
1 x Left panel	1 x Right panel	3 x Back panel	2 x Outer lid assembly	1 x Centre lid assembly	3 x Door
					
2 x Dividing frame	3 x Prop	1 x Hinge strip	1 x Finishing strip		
					

Step 1



Begin by arranging the left panel (the one with the small wood block attached to the front post) and the back panel at 90° to each other, with the back panel raised up on the spacer blocks by approximately 25mm. Use 3 x shorter screws to secure as shown.

Step 2

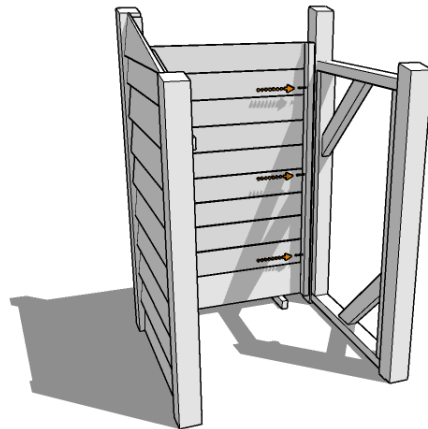

Now add the Dividing frame, fixing in the same way with 3 x shorter green screws.

Step 3

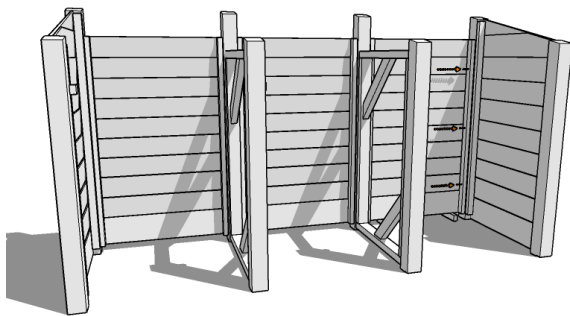

Continue by adding the remaining back panel and final side panel in the same manner as before.

Step 4

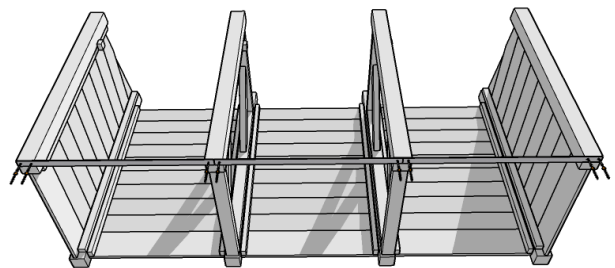

Carefully lay the assembly on its back and attach the metal bars, the centre bar being the shorter one, to the front bottom edge of the 3 front posts as shown, securing in place with 2 x shorter green screws per post.

Step 5

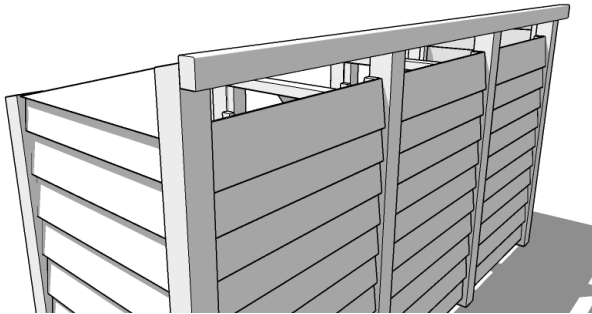

Stand the assembly back up and position the Hinge strip at the top of the rear posts...

Step 6

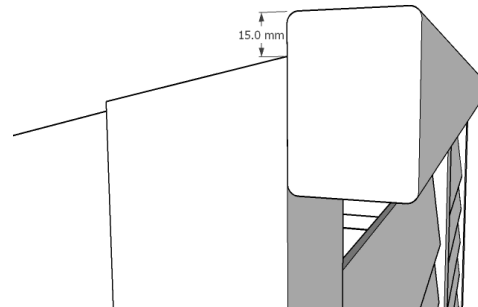

...set the hinge bar so that the top edge sits approx. 15mm above the top of the rear post and secure in place with a longer green screw into each of the 3 posts.

Step 7

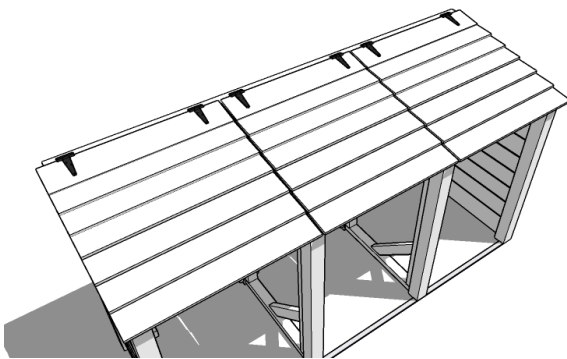

Lower the lid assemblies into place, the centre lid being the narrower one, and position them so that the hinge knuckles sit against the hinge strip...

Step 8

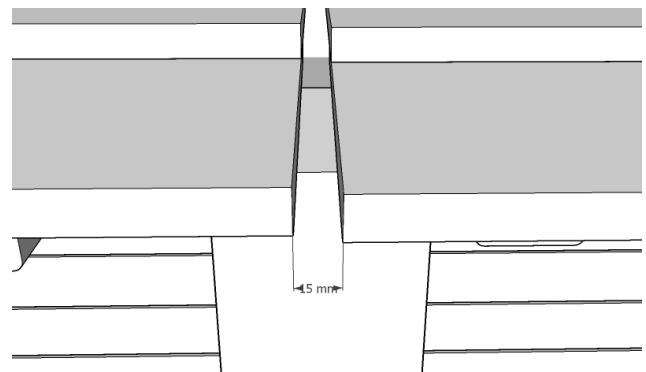

..and there is a 15mm gap between the lid panels before fixing the hinges into place with 3 x black screws per hinge into the hinge strip.

Step 9

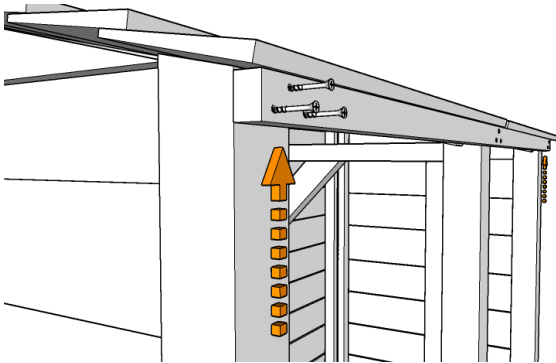

Returning to the front of the store, place the finishing strip against the 3 front posts as shown with the screw holes configured to create a triangle and slide it upwards until it is just touching the underside of the lid. Now fix in place with 3 x shorter green screws per post.

Step 10

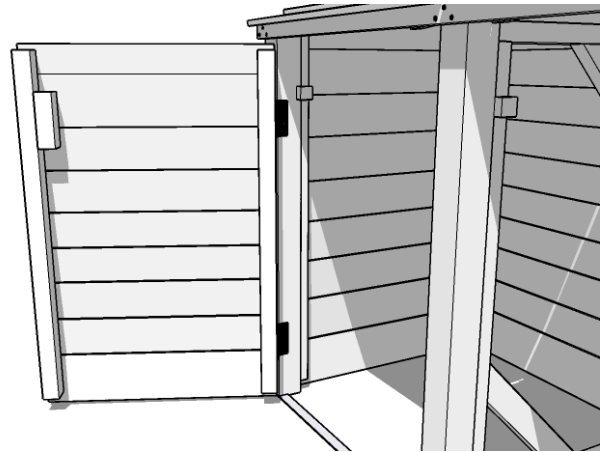

Align the door (hinge side on the left) so that the top edge clears the underside of the finishing strip by approx 10mm and each hinge leaf sits flat against the post with the knuckles resting against the front edge of the post. Secure the hinges in place using 8 x black screws.

Step 11

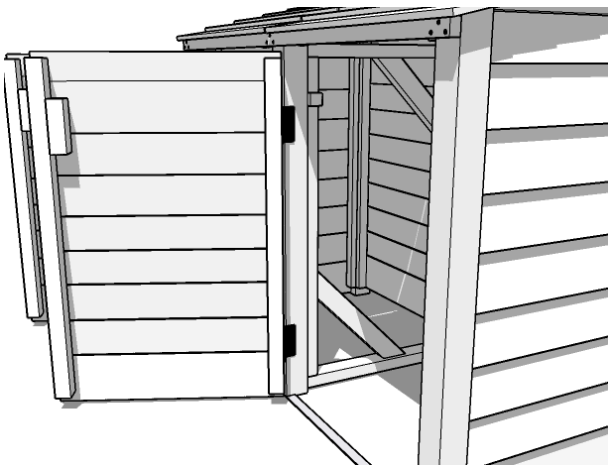

Attach the second and third door in the same manner.

Step 12

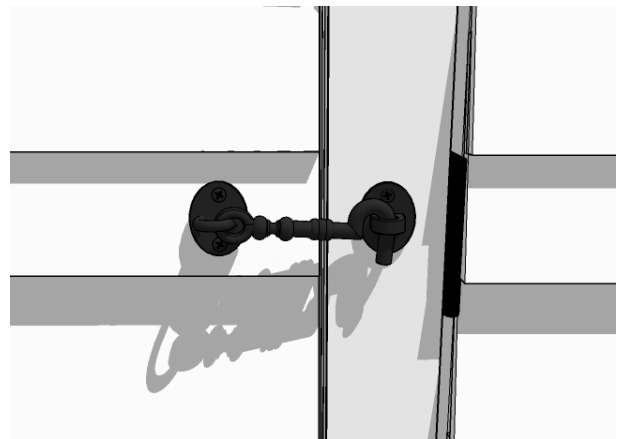

Position the cabin latch keep on the post and aligned horizontally with each latch as shown. Secure in place with 2 x black screws then repeat for the second and third door.

Step 13

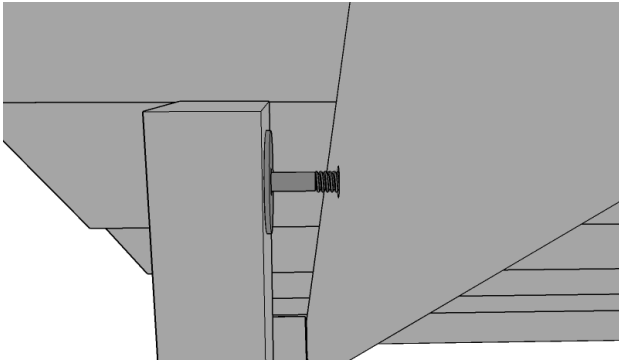

Take the coach bolt from the prop fixing and push it through the hole in the prop, add a washer and then push through the hole in the lid batten as shown.

Step 14

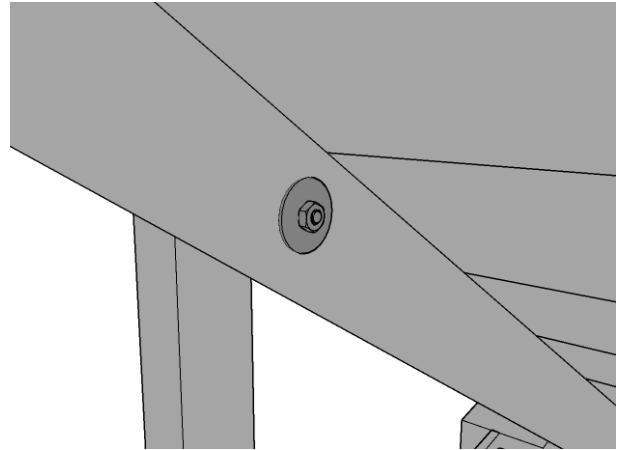

Place another washer over the coach bolt and finally the securing nut. Tighten with a spanner or socket until fully tight and then back off until the prop is able to swing freely. Attach the second and third prop in the same manner.

Step 15

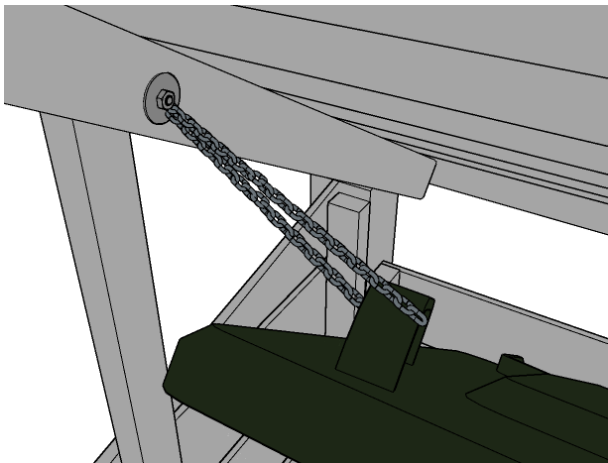

If your bin lid has a suitable handle you may use the chain provided to attached this to the store lid. Undo the nut and slip one end over the coachbolt, then pass other end through the handle and then over the end of the coach bolt, pulling chain through until it is tight enough. Now re-attach the nut.

Step 16

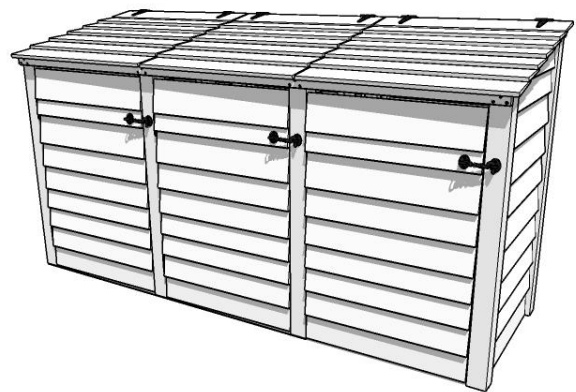

Your Morcott Triple Bin Store is now complete.