

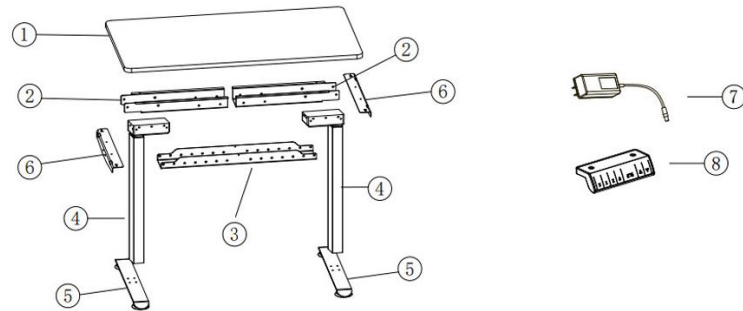









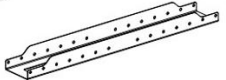
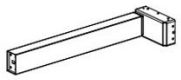

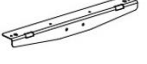

# Electric adjustable desk installatllation drawing

## Parts List







①  Table board(×1)	②  Wire box on both sides(×2)	③  Intermediate trunking(×1)
④  Column(×2)	⑤  Footing(×2)	⑥  Tabletop bracket(×2)
⑦  Adapter(×1)	⑧  Controller(×1)	⑨

## Screw package list

A  Screws M8×10(×8)	B  Nut(×8)	C  Screws M6×12(×28)	D  Screws ST4×15(×16)
E  Shim ring(×8)	F  Adjustable leveling feet(×4)	G  T-type wrench(×1)	H  Cross screwdriver(×1)

## Spare screw package list

A  Screws M8×10(×1)	B  Nut(×1)	C  Screws M6×12(×2)	D  Screws ST4×15(×2)
E  Shim ring(×1)			

## Installation step 1

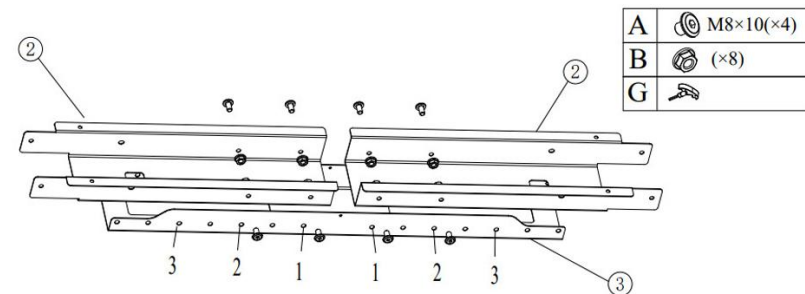

### Installation Notes:

- The holes on both sides are symmetrically matched and fixed with A and B.  
Fixed hole 1 :Use with 1200 ×600 desktop.  
Fixed hole 2 :Use with 1400 ×600 desktop.  
Fixed hole 3 :Use with 1600 ×700 and 1800 ×800 desktop.

## Installation step 2

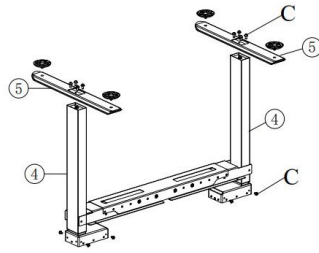

C	M6×12(×8)
F	(×4)
G	

### Installation Notes:

1. Install the column on the components in step 1 and fix them with C.
2. Install the table legs on the column and fix them with C.
3. Install the adjustable on the table legs.

## Installation step 3

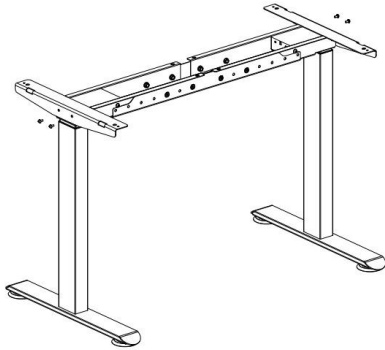

C	M6×12(×4)
G	

### Installation notes:

1. Install ⑥ on step 2 and secure with C.

## Installation step 4

### Check lifting and lowering:

1. Untie the cable of the table leg, pass through the cable slot below, and connect it to ⑧ (The side away from the controller is a long motor line).

2. Connect ⑦ and ⑧.

3. After the power supply is turned on, press and hold the button to reset, then lift and lower one back and forth before installing the table board.

## Installation step 5

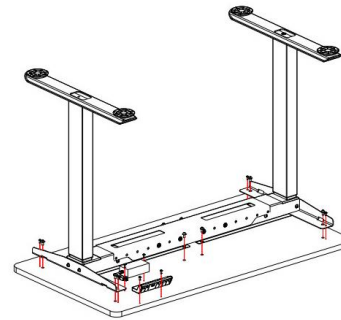

C	M6×12(×8)
D	ST4×15(×8)
G	
H	

### Installation Notes:

1. Install ① on step 4 and secure with C and D. (C can be replaced with D and E for use.)
2. Use E to fix ⑧ and ⑨ on the desktop board.

## Complete

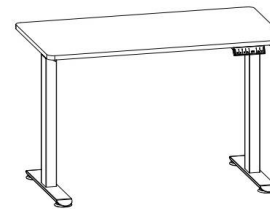

### Instructions for use:

1. Press  to reset the lowest position or error code duration.
2. Memory position saving: Run the desktop to the desired position, press the S key, the display screen will flash, and then press the corresponding number key.
3. Short press the number keys to reach the set height, and press any key to stop the operation during operation.

## Installation of Special Legs:

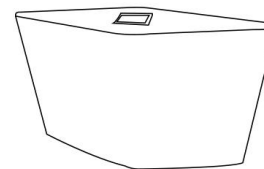

The special legs shown in the diagram can directly replace ④ and ⑤ for the next stage of installation, eliminating the need for installing regular table legs.