

ASSEMBLY INSTRUCTION

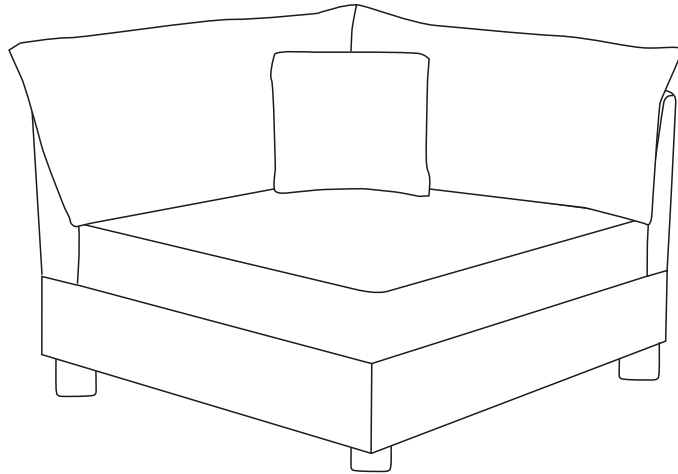

Sets often ship in multiple boxes and delivery date may vary.

CUSTOMER SERVICE

**Questions, Missing parts, Assembly help?
No need to return the product, we will gladly help and ship
your replacement parts free of charge.**

PRE-ASSEMBLY INFORMATION

Please read this manual carefully before beginning assembly of this product. Keep this manual for future reference.

NOTICE

1. Please assemble it all boxes are received.
2. Please do not throw away any of the packages or the instruction until the sofa is fully assembled.
3. Please keep children away from the plastic bags or any small pieces of stuff.
4. Some key parts of our product may be stored and hidden inside of other parts. Please open any zippered or hook & loop storage compartments to take out all parts.
5. Please do not open the compressed packages until your sofa frame is completely assembled.
6. As the cushions are all vacuum compressed, there will be some wrinkles. Please give them up to 72 hours to reach its original size and the wrinkles will basically disappear.
7. DO NOT INSTALL THE SCREWS ALL THE WAY IN THE BEGINNING. Place each screw into their proper hole and use your hand to twist the screw halfway. Twist all the screws in halfway to ensure the holes will match up properly and the product is level on the ground. When everything seems fitted, then tighten the screws.
8. Do not over tighten screws and bolts to avoid stripping.



2 adults recommended



Takes about 1.5 Hours to assemble



Weight capacity of each seat: 330LBS

COMPONENTS

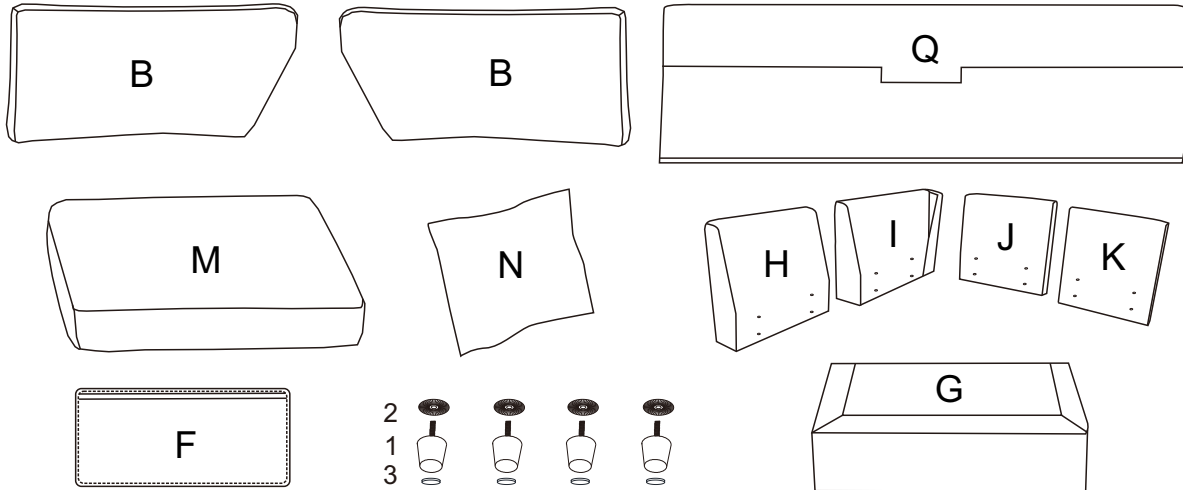

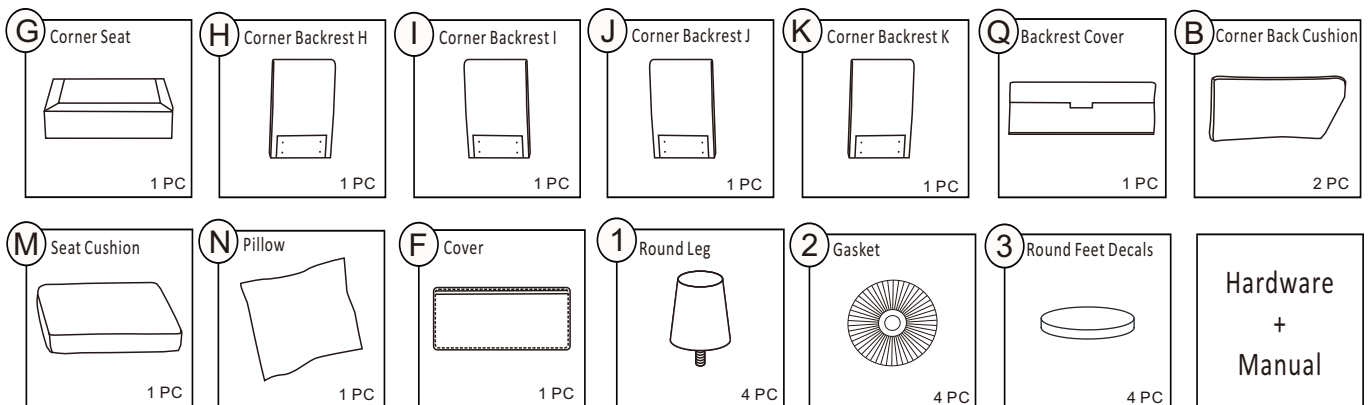

HARDWARE			
NO	DESCRIPTION	SKETCH	QTY
4	Screws 8x40		16
5	Washer		24
6	Hex Key		1
7	Screws 8x70		4
8	Screws nut		4
9	Spanner		1



ASSEMBLY STEPS

STEP 1

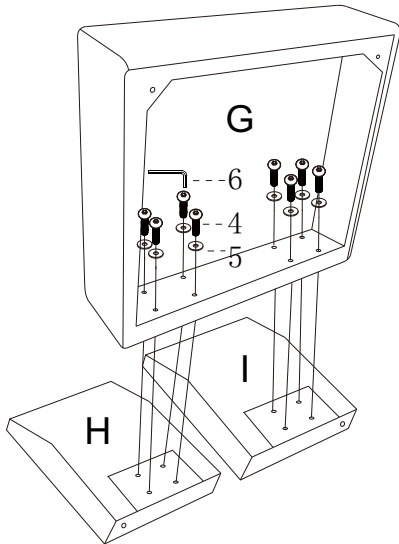

Connect corner seat frame (G) to the backrests (H&I) with screws(4) and washers (5) by hex key(6).

4		8
5		8
6		1



STEP 2

Connect corner seat frame (G) to the backrests (J&K) with screws(4) and washers (5) by hex key(6).

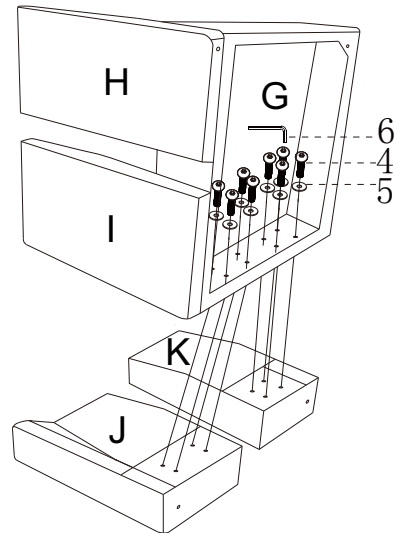

4		8
5		8
6		1



STEP 3

Put the cover (Q) on the backrest.

Attach legs(1) and gaskets(2) to the seat frame. Stick the feet decals(3) onto each leg.

1		4
2		4
3		4

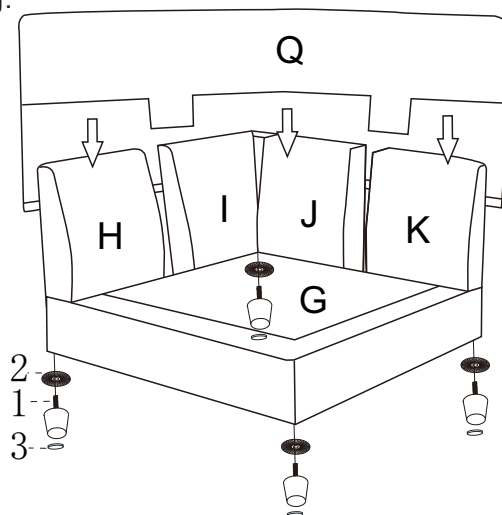

STEP 4

Open the vacuum bag and take the cushions (D&M), pillows (N) out. To restore the original shape, follow the steps below.



Open the vacuum bag carefully.



Press and tap with both hands from the side to fully inhale air

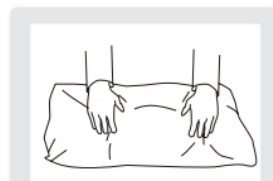

Press and tap with both hands from the front to fully inflate.



Carefully smooth out each section until the surface is even.

After packing up, place them in somewhere dry and ventilated. After about 72-96 hours. It can be restored to the best use condition.

ASSEMBLY STEPS



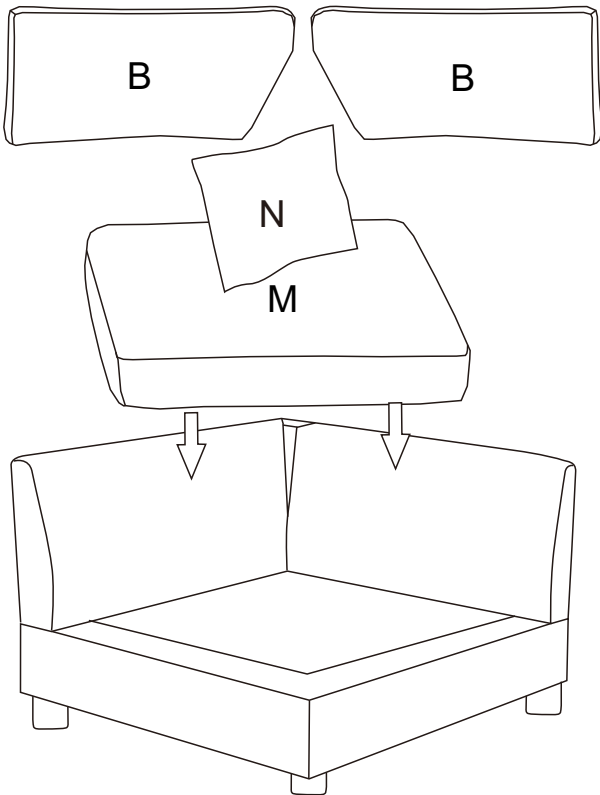

STEP 5 Put the cushions (B&M) and pillow (N) on the sofa.

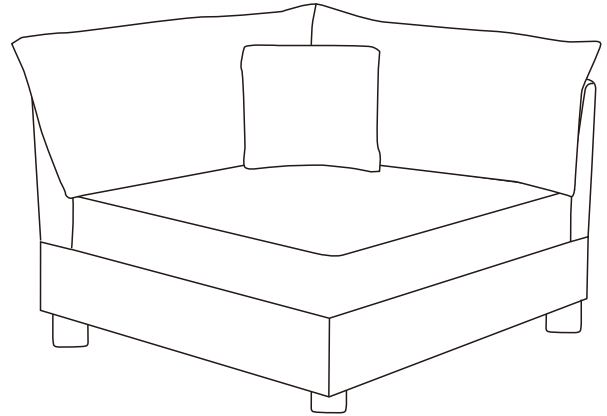

STEP 6 Complete



STEP 6
Connect corner seat frame (G) to the other part with screws (7), washers (5) and screws nut (8) by hex key (6) and spanner (9).

5		8
6		1
7		4
8		4
9		1

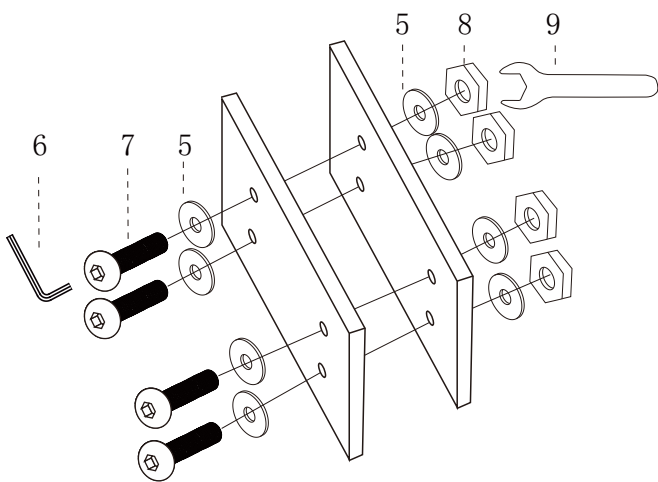

Multiple combinations

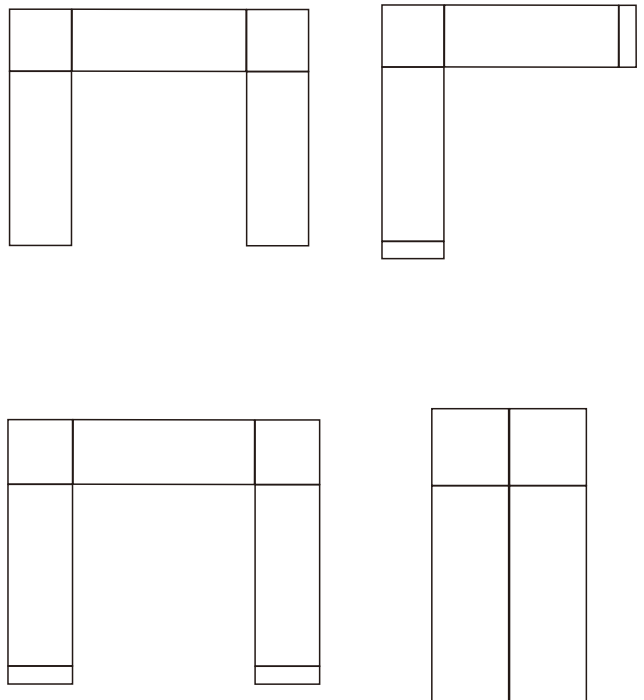

ASSEMBLY INSTRUCTION

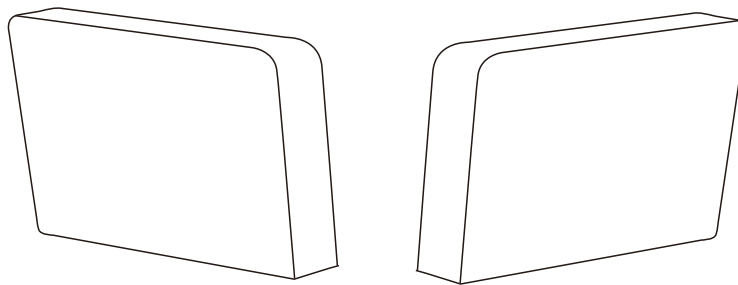

Sets often ship in multiple boxes and delivery date may vary.

CUSTOMER SERVICE

**Questions, Missing parts, Assembly help?
No need to return the product, we will gladly help and ship
your replacement parts free of charge.**

PRE-ASSEMBLY INFORMATION

Please read this manual carefully before beginning assembly of this product. Keep this manual for future reference.

NOTICE

1. Please assemble it all boxes are received.
2. Please do not throw away any of the packages or the instruction until the sofa is fully assembled.
3. Please keep children away from the plastic bags or any small pieces of stuff.
4. Some key parts of our product may be stored and hidden inside of other parts. Please open any zippered or hook & loop storage compartments to take out all parts.
5. Please do not open the compressed packages until your sofa frame is completely assembled.
6. As the cushions are all vacuum compressed, there will be some wrinkles. Please give them up to 72 hours to reach its original size and the wrinkles will basically disappear.
7. DO NOT INSTALL THE SCREWS ALL THE WAY IN THE BEGINNING. Place each screw into their proper hole and use your hand to twist the screw halfway. Twist all the screws in halfway to ensure the holes will match up properly and the product is level on the ground. When everything seems fitted, then tighten the screws.
8. Do not over tighten screws and bolts to avoid stripping.



2 adults recommended



Takes about 1.5 Hours to assemble



Weight capacity of each seat: 330LBS

COMPONENTS

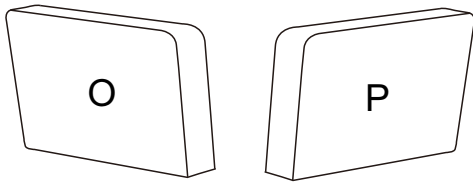

HARDWARE			
NO	DESCRIPTION	SKETCH	QTY
4	Screws 8x40		8
5	Washer		8

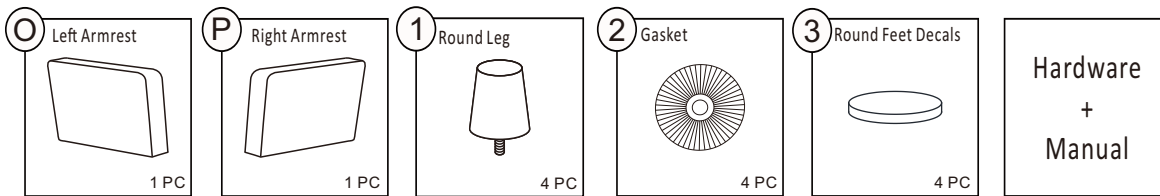

ASSEMBLY STEPS

STEP 1

Connect the armrests (O&P) to the other part with screws(4) and washers(5) by hex key(6).

4		8
5		8
6		1

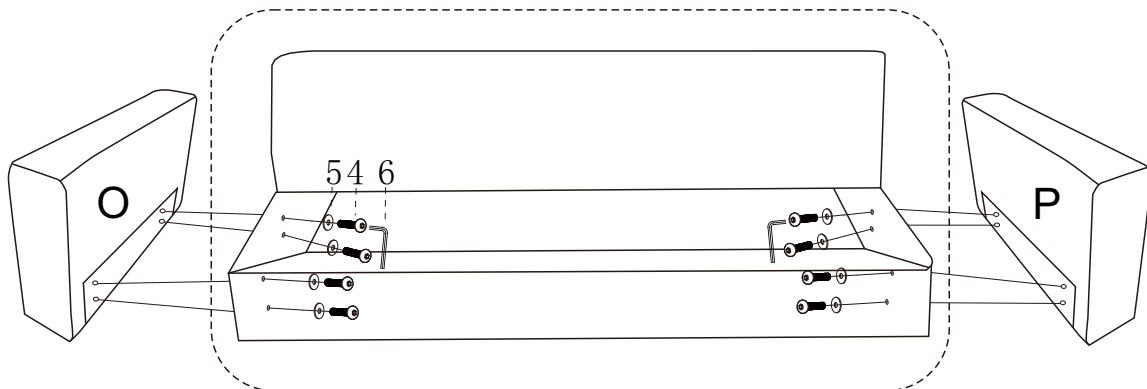

Not included in this package

ASSEMBLY STEPS

STEP 2

Complete.
The legs in this package are complimentary.
You can choose to install or not.

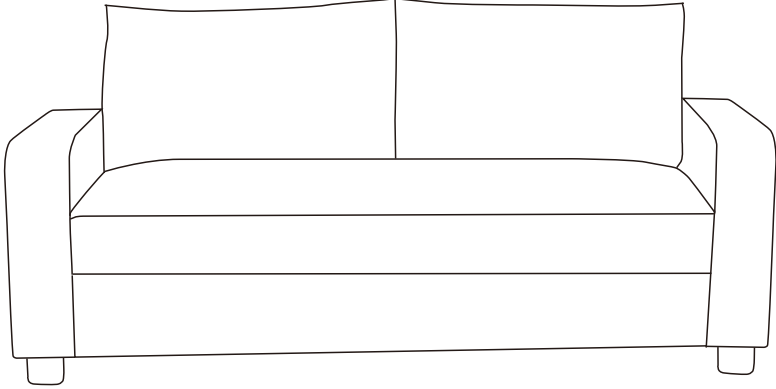

Multiple combinations

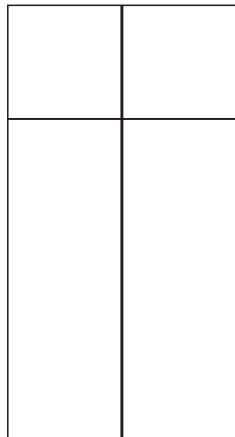
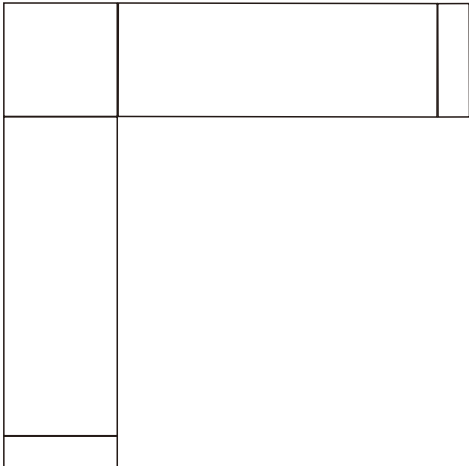
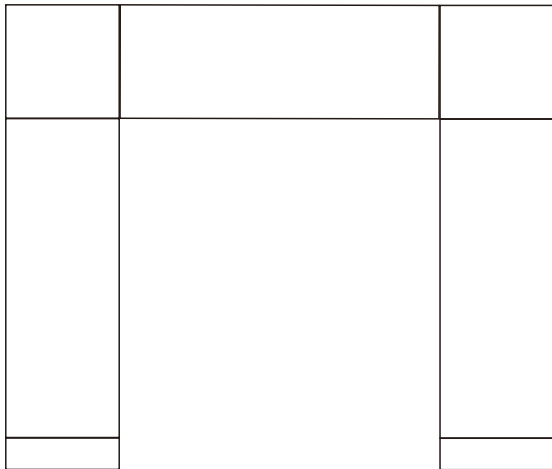
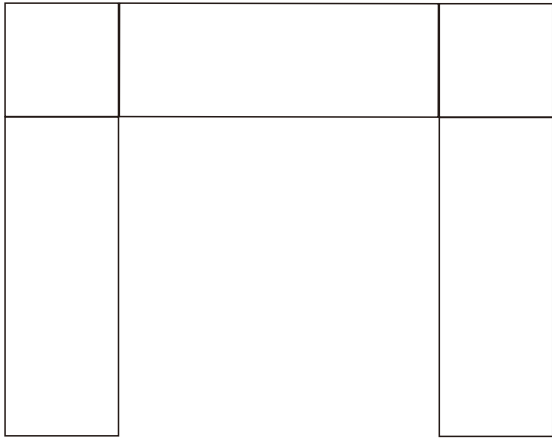

ASSEMBLY INSTRUCTION

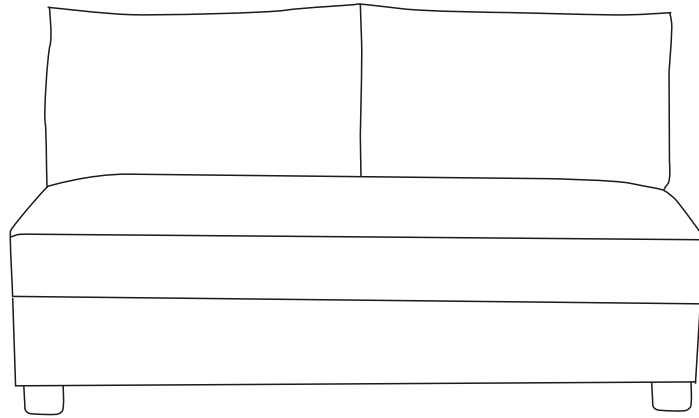

Sets often ship in multiple boxes and delivery date may vary.

CUSTOMER SERVICE

**Questions, Missing parts, Assembly help?
No need to return the product, we will gladly help and ship
your replacement parts free of charge.**

PRE-ASSEMBLY INFORMATION

Please read this manual carefully before beginning assembly of this product. Keep this manual for future reference.

NOTICE

1. Please assemble it all boxes are received.
2. Please do not throw away any of the packages or the instruction until the sofa is fully assembled.
3. Please keep children away from the plastic bags or any small pieces of stuff.
4. Some key parts of our product may be stored and hidden inside of other parts. Please open any zippered or hook & loop storage compartments to take out all parts.
5. Please do not open the compressed packages until your sofa frame is completely assembled.
6. As the cushions are all vacuum compressed, there will be some wrinkles. Please give them up to 72 hours to reach its original size and the wrinkles will basically disappear.
7. DO NOT INSTALL THE SCREWS ALL THE WAY IN THE BEGINNING. Place each screw into their proper hole and use your hand to twist the screw halfway. Twist all the screws in halfway to ensure the holes will match up properly and the product is level on the ground. When everything seems fitted, then tighten the screws.
8. Do not over tighten screws and bolts to avoid stripping.



2 adults recommended



Takes about 1.5 Hours to assemble



Weight capacity of each seat: 330LBS

COMPONENTS

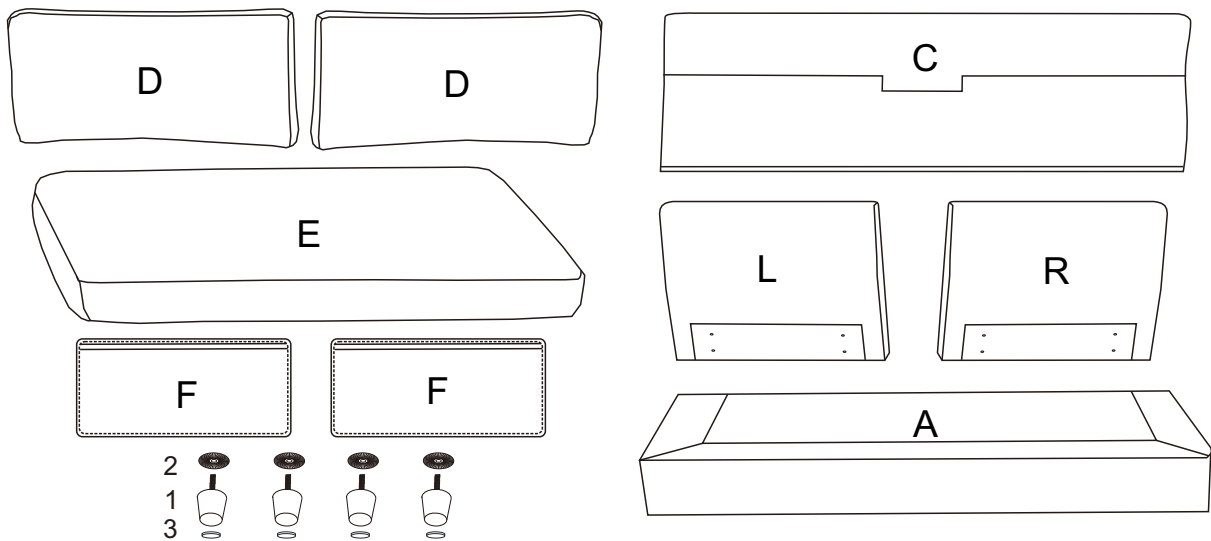

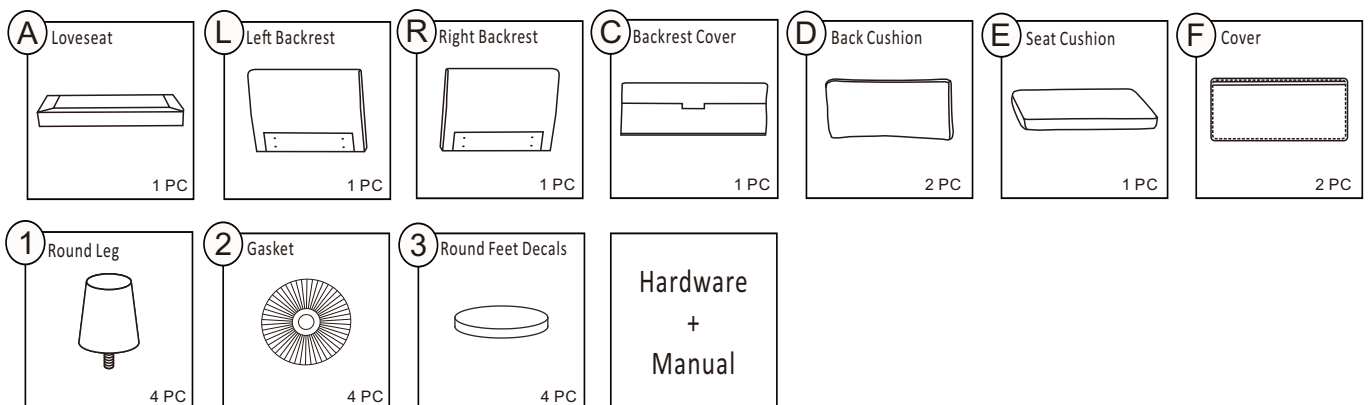

HARDWARE			
NO	DESCRIPTION	SKETCH	QTY
4	Screws 8x40		8
5	Washer		16
6	Hex Key		1
7	Screws 8x70		4
8	Screws nut		4
9	Spanner		1



ASSEMBLY STEPS

STEP 1

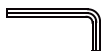

Connect seat frame (A) to the backrests (L&R) with screws(4) and washers(5) by hex key(6).

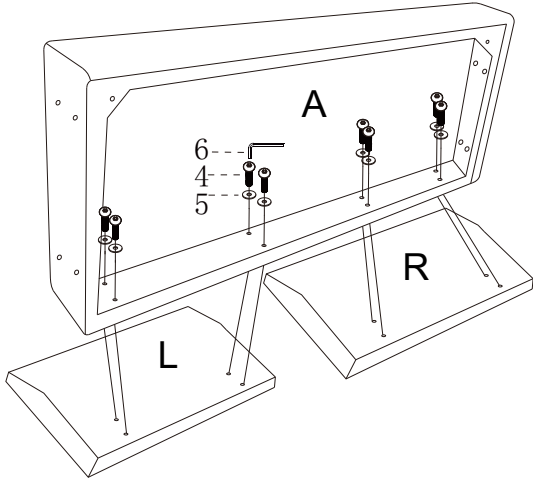
4		8
5		8
6		1



STEP 2

Put the cover (C) on the backrest.
Attach covers (F) to the both side of seat frame.
Attach legs(1) and gaskets (2) to the seat frame.
Stick the feet decals (3) onto each leg.

1		4
2		4
3		4

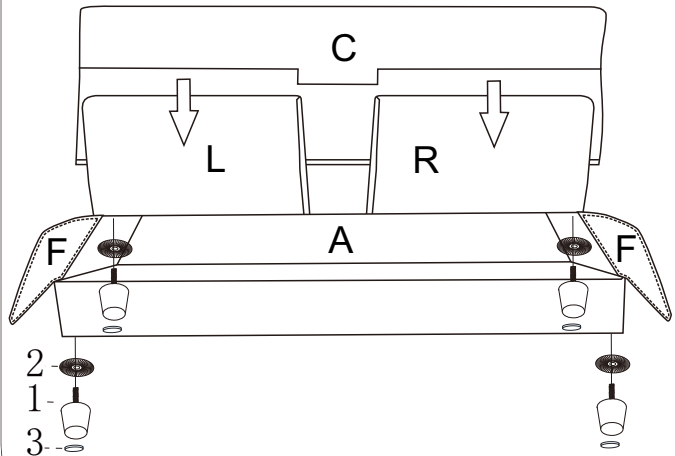

STEP 3

Open the vacuum bag and take the cushions (D&E) out.
To restore the original shape, follow the steps below.

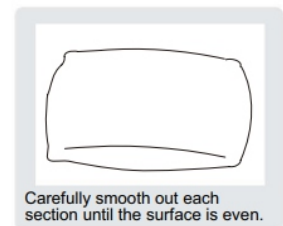
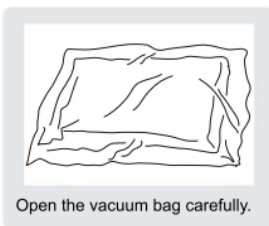

After packing up, place them in somewhere dry and venslated. After about 72-96 hours. It can be restored to the best use condition.

STEP 4

Put the cushions (D&E) on the sofa.

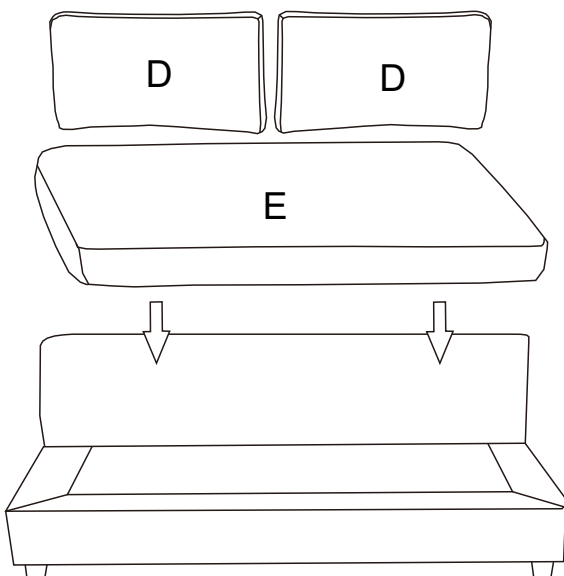

STEP 5

Complete

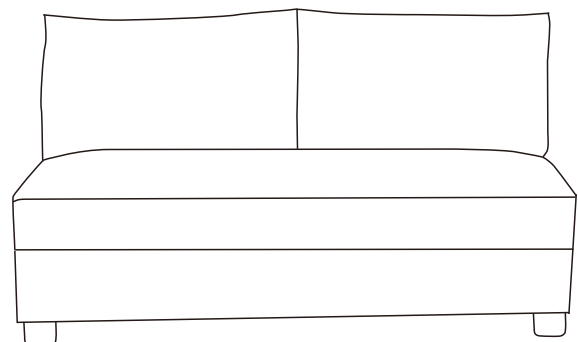



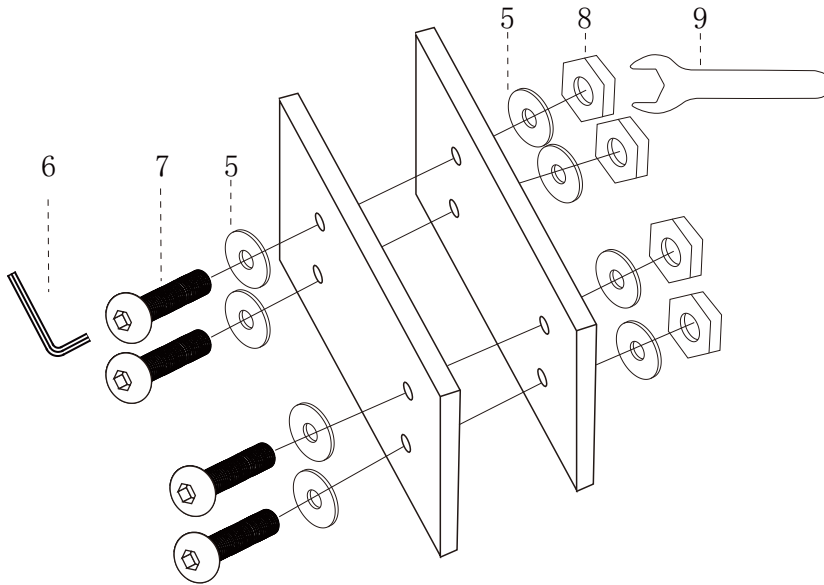

ASSEMBLY STEPS

STEP 6

Connect seat frame (A) to the other part with screws(7), washers(5) and screws nut (8) by hex key(6) and spanner (9).



5		8
6		1
7		4
8		4
9		1

Multiple combinations

