

# Assembly | Asamblea | Assemblage

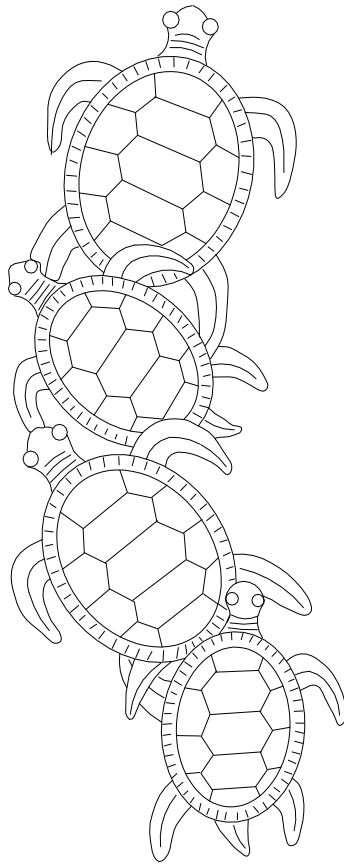

# Assembly | Asamblea | Assemblage

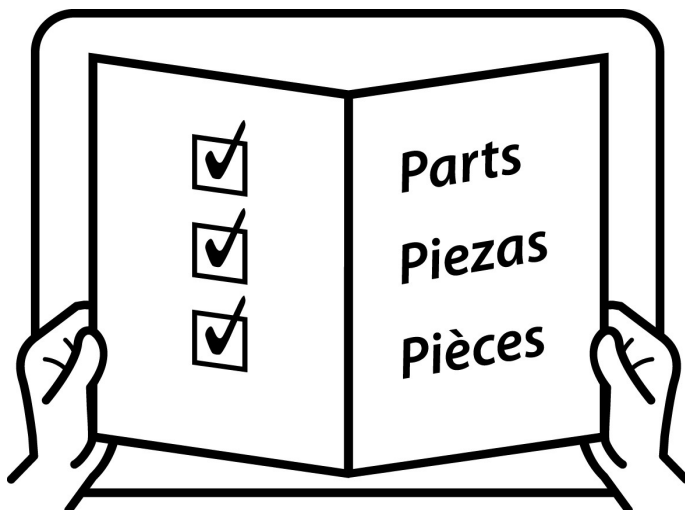
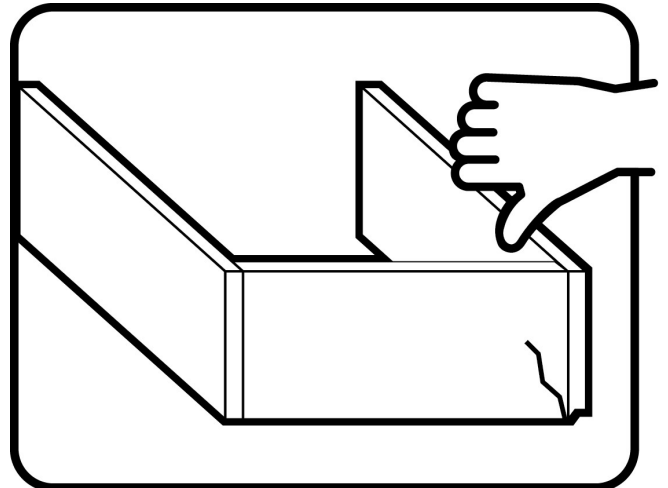
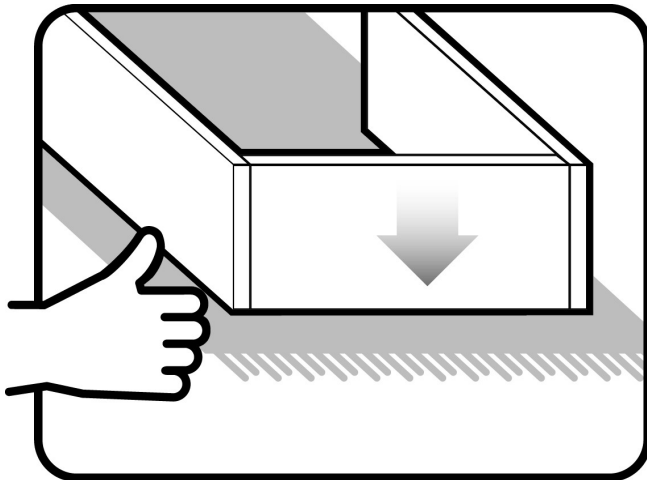
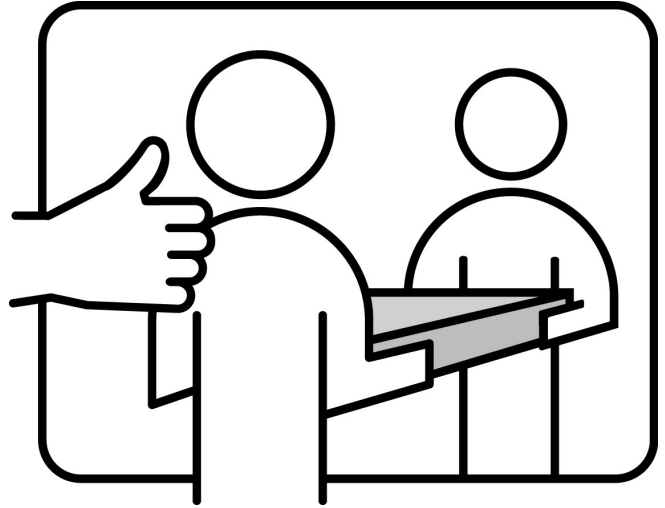
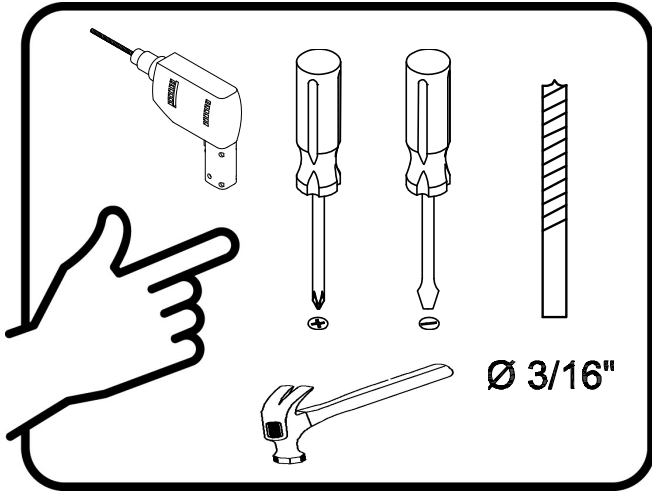

# Assembly | Asamblea | Assemblage

Techniques | Técnicas | Techniques

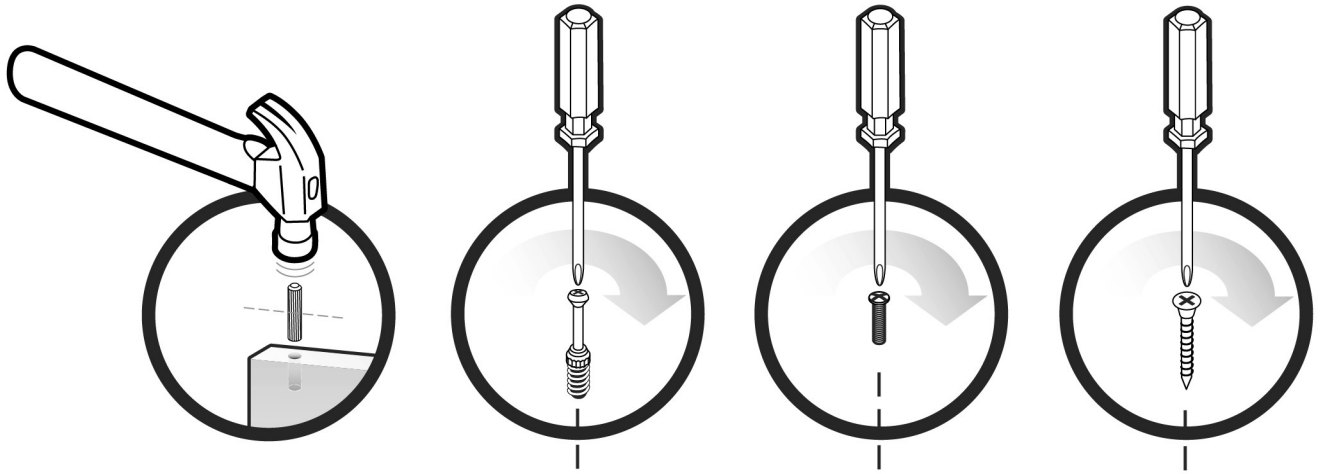

Care | Cuidado | Entretien

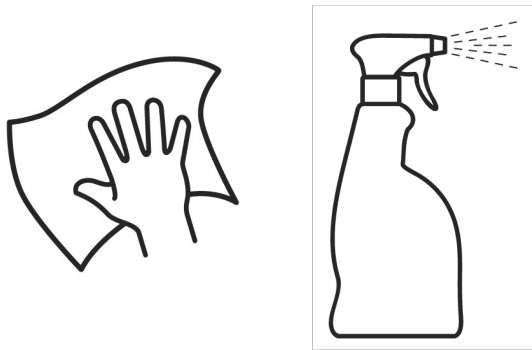

Safety | Seguridad | Sécurité



Note! | Nota: | Remarque!



# Assembly | Asamblea | Assemblage

A

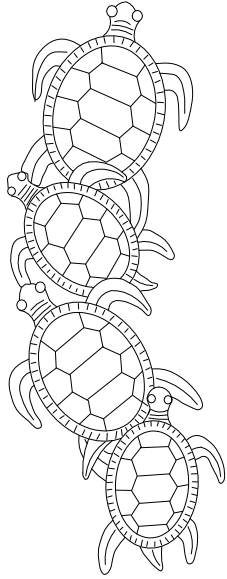

Quantity  
of 1

Outdoor wall Sculpture

1

Quantity  
of 1

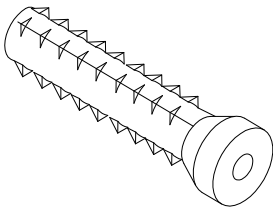

Plastic Anchor

2

Quantity  
of 1

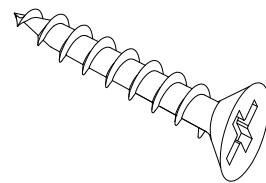

Screw  $\varnothing$  5/16"\*1-1/2"L

# Assembly | Asambla | Assemblage

1.

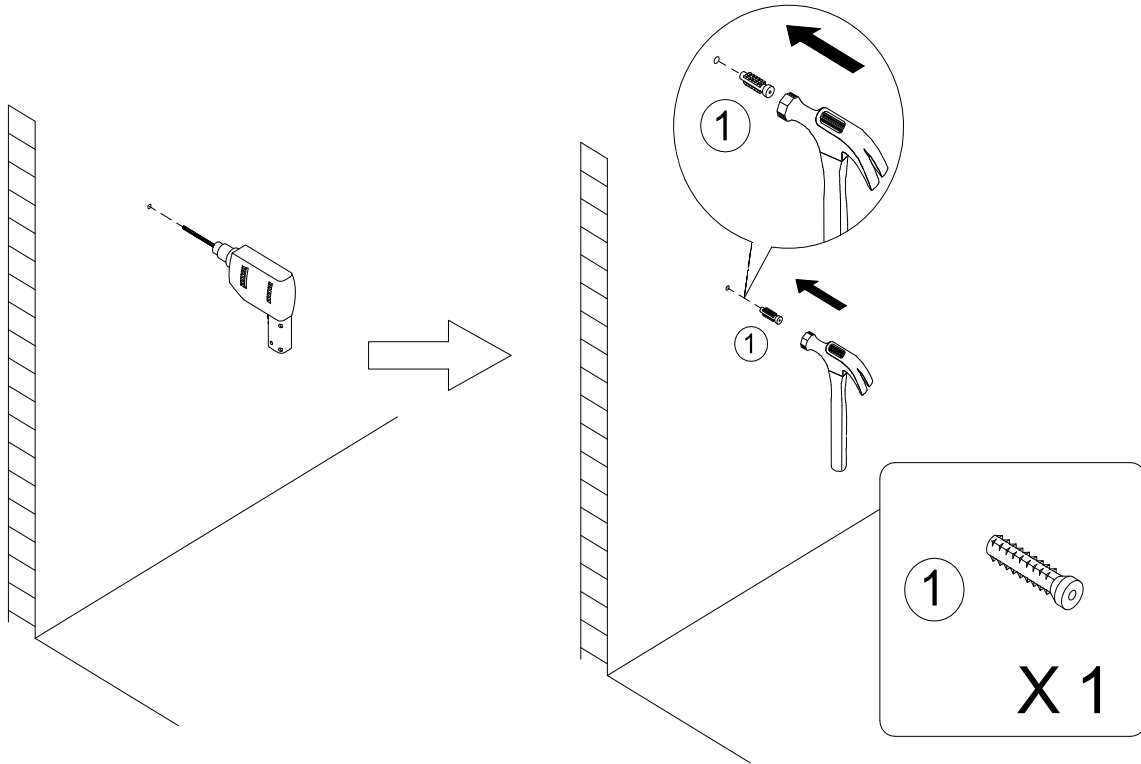

2.

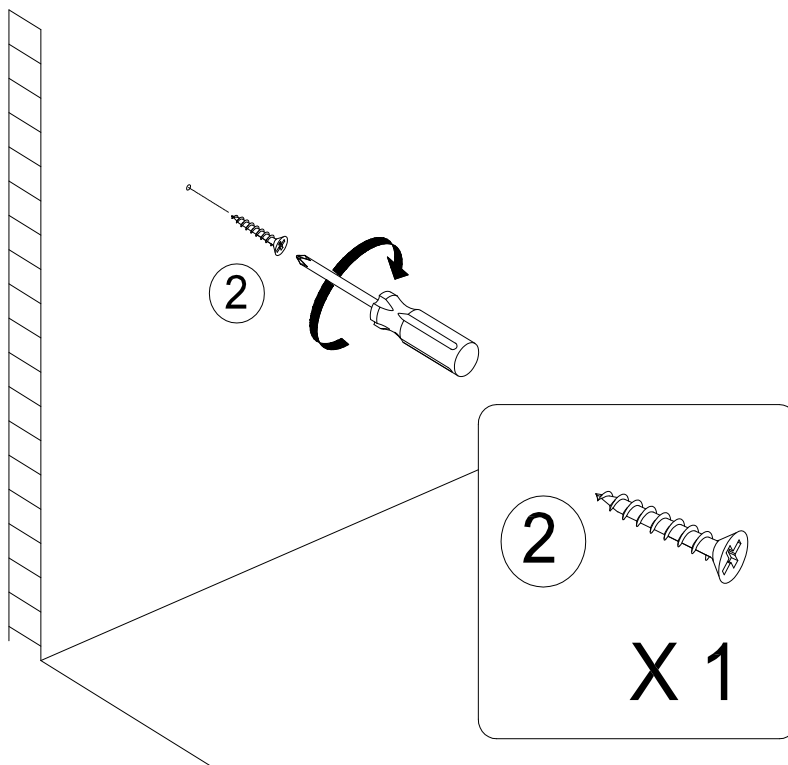

# Assembly | Asambla | Assemblage

3.

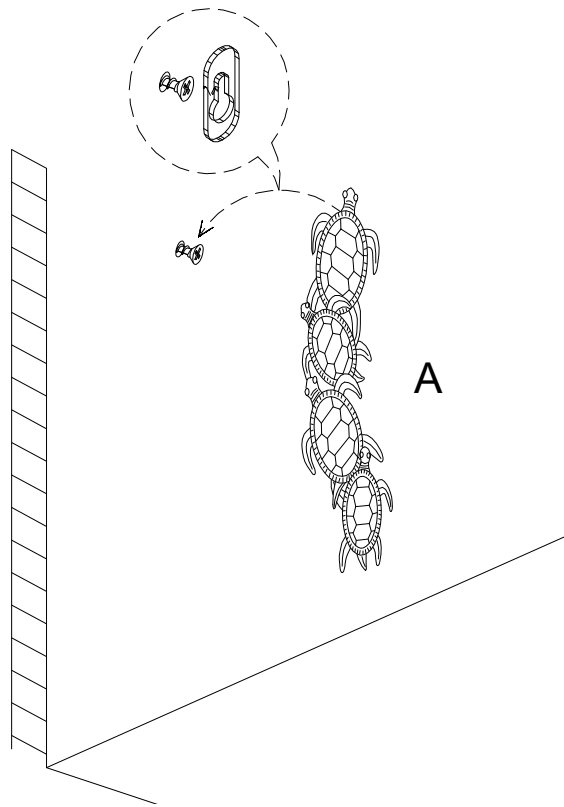

4.

