

Installation & Assembly

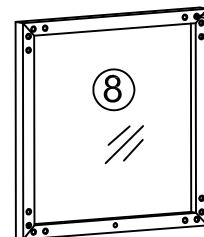
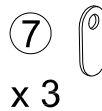
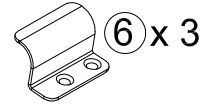
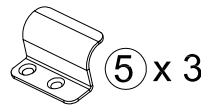
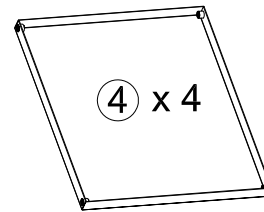
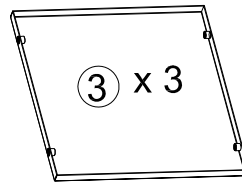
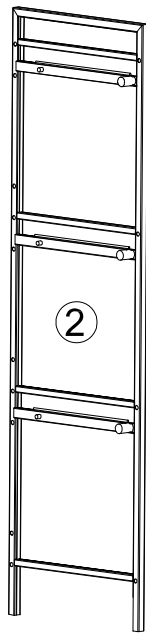
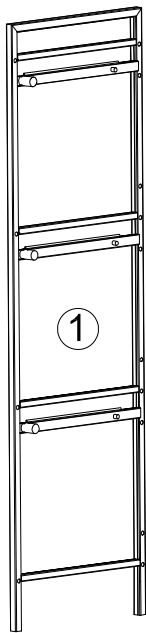

Hardware component L has been pre-assembled in component 8.

A	x 28	B	x 3	C	x 4	D	x 3	E	x 3	F	x 1
M6x25mm		M4x25mm		Φ15xM6x15mm		Φ10xΦ5x1.0mm		Φ20xΦ11xM4mm		M4mm	
G	x 2	H	x 2	I	x 2	J	x 2	K	x 3	L	x 12
73x25x16mm		Φ6x30mm		M6x12mm		Φ4x30mm		Φ10x1.0mm			

1

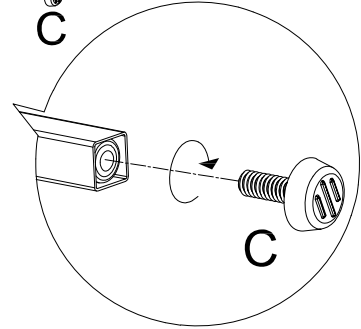
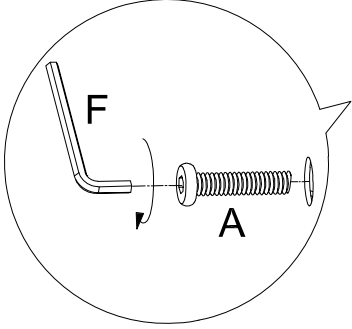
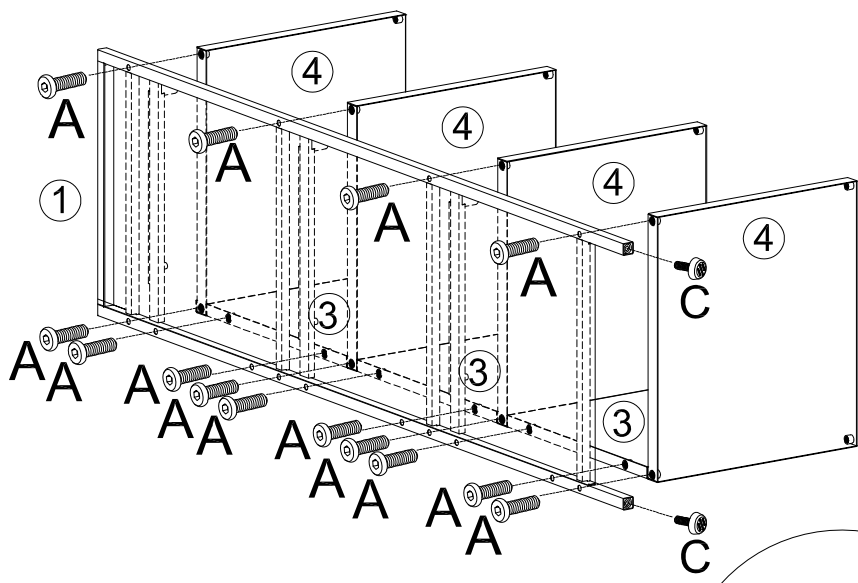

A	x 14
M6x25mm	

C	x 2
Φ15xM6x15mm	

2

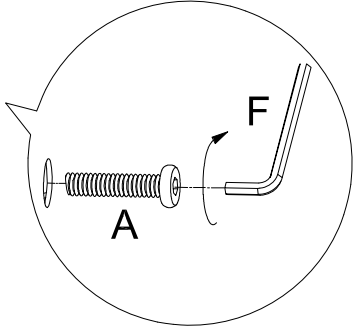
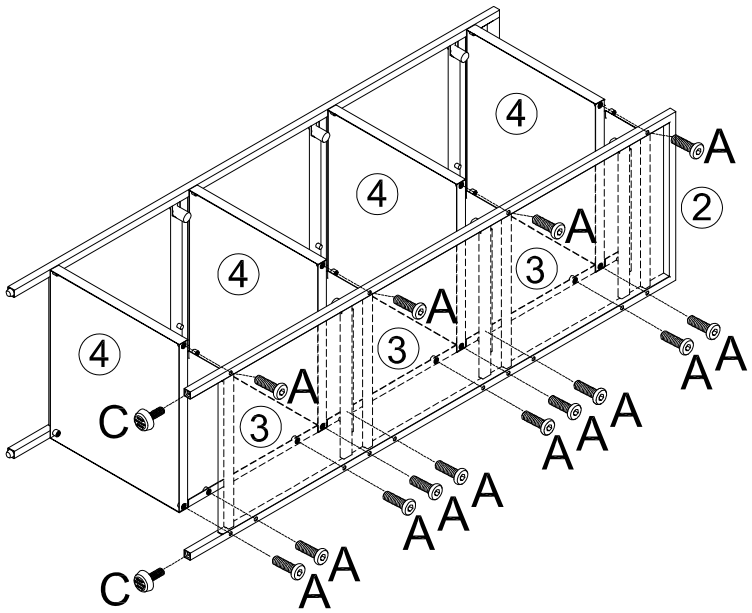

A	x 14
M6x25mm	

C	x 2
Φ15xM6x15mm	

3

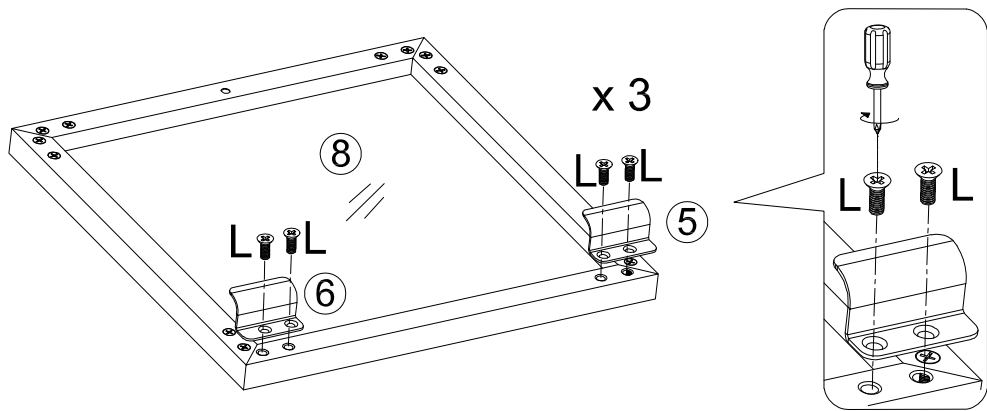
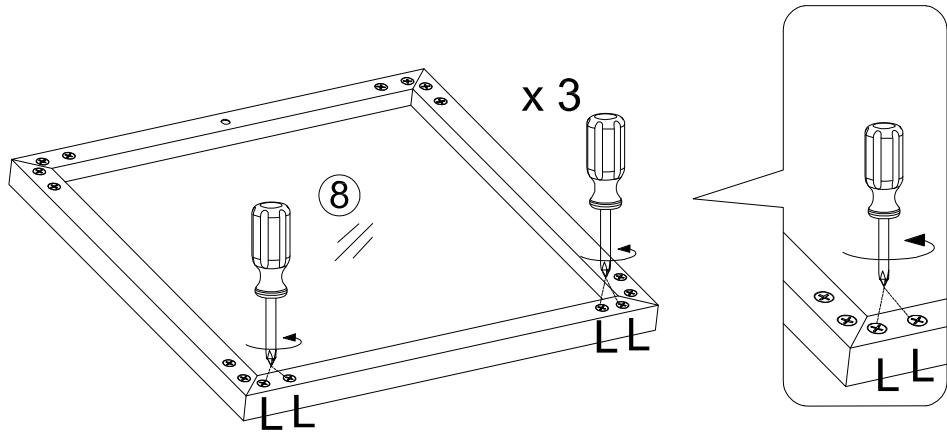

4

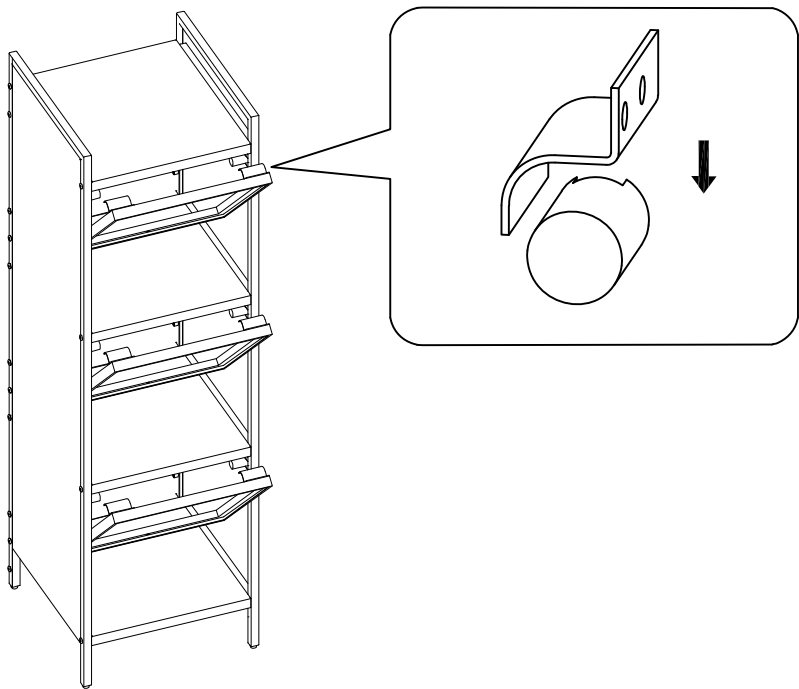

5

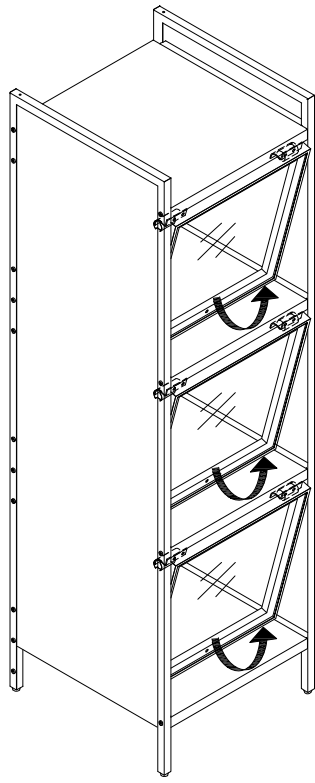

6

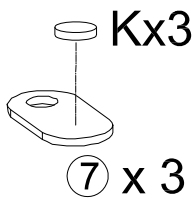
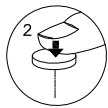

B	x 3
M4x25mm	

D	x 3
Φ10xΦ5x1.0mm	

E	x 3
Φ20xΦ11xM4mm	

K	x 3
Φ10x1.0mm	

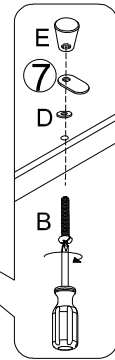
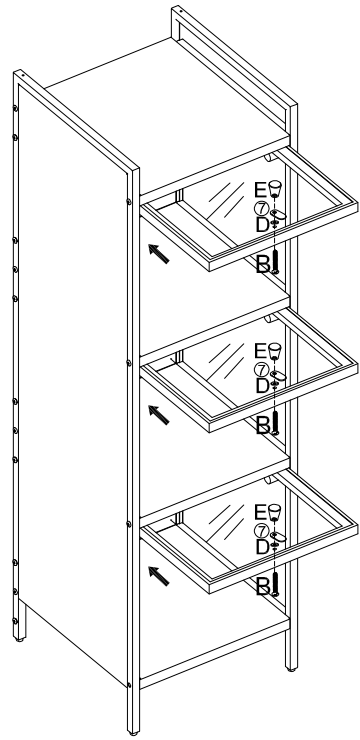

7

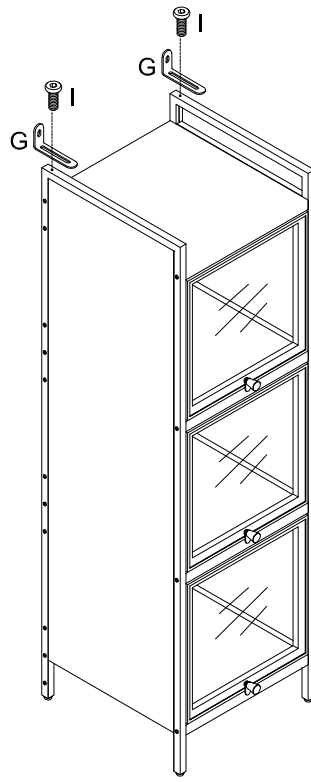



G	x 2
	
73x25x16mm	

I	x 2
	
M6x12mm	

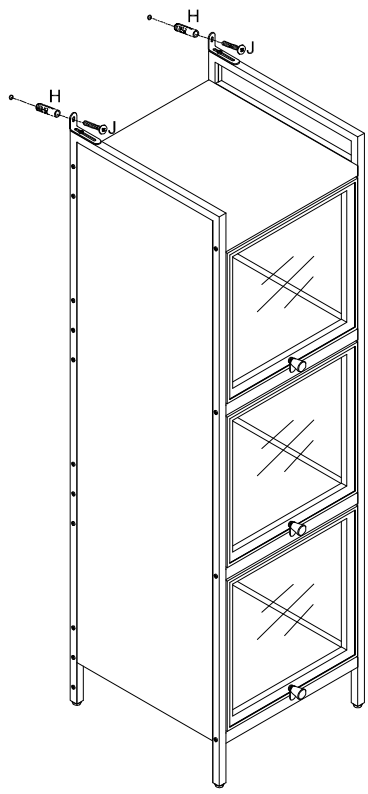
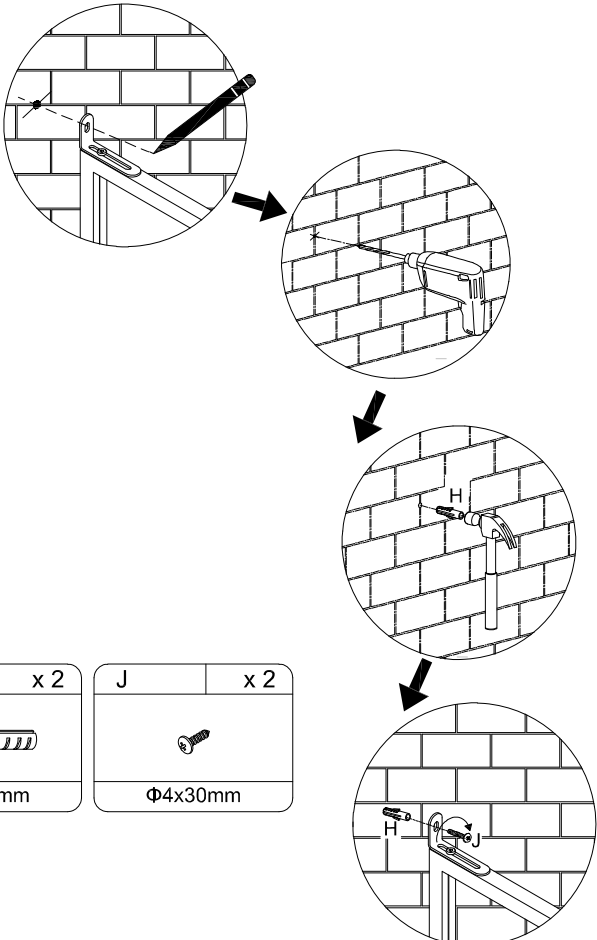
8



H	x 2
	
Φ6x30mm	

J	x 2
	
Φ4x30mm	