

ASSEMBLY INSTRUCTION

Friendly Reminder:

- 1.This sofa is packed in 6 boxes. Please assemble it After all boxes are received.
- 2.As the cushions are all vacuum compressed,there will be some wrinkles. Please give your cushions up to 72 hours to reach its original size and the wrinkles will basically disappear.
- 3.Please do not open the compressed packages until your sofa frame is completely assembled.

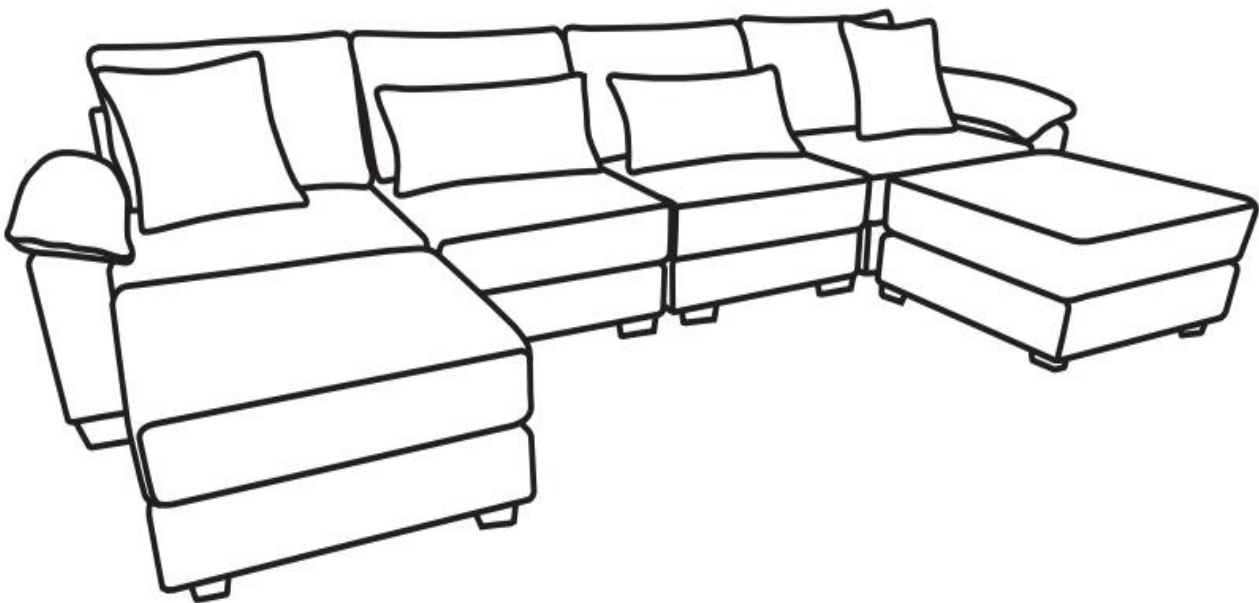







Return & warranty policy



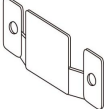

- we strive to offer the highest quality products , and we also try our best to satisfy each and every customer that orders from us with replacement parts or service as needed.
- If the item is damaged or defective , please take photos as evidence for replacements and refunds.
- please do not return to store , contact the seller if you have any troubles with this product.

ASSEMBLY INSTRUCTION

HARDWARE





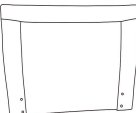
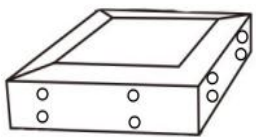
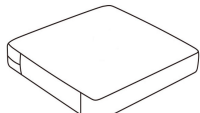

NO	DESCRIPTION	SKETCH	QTY
1	Plastic gasket		4
2	Felt mat		4
3	Iron gasket	 8*22MM	8
4	Screw	 M8*30MM	8
5	Screw	 M6*16MM	4
6	Wrench	 M6	1
7	Insert		2

PART LIST

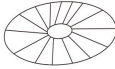
NO	DESCRIPTION	SKETCH	QTY
A	Main leg		4
B	Armrest pillow		1
C	Backrest pillow (big)		1
D	Armrest		1
E	Backrest		1
F	Seat frame		1
G	Seat cushion		1

ASSEMBLY INSTRUCTION

HARDWARE

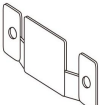

NO	DESCRIPTION	SKETCH	QTY
1	Plastic gasket		4
2	Felt mat		4
3	Iron gasket	 8*22MM	4
4	Screw	 M8*30MM	4
5	Screw	 M6*16MM	8
6	Wrench	 M6	1
7	Insert		4

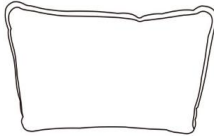
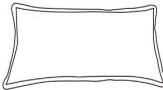
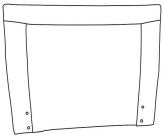
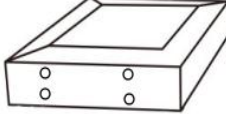
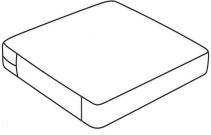
PART LIST

NO	DESCRIPTION	SKETCH	QTY
A	Main leg		4
C	Backrest pillow (big)		1
H	Backrest pillow (small)		1
E	Backrest		1
I	Seat frame (with a backrest)		1
G	Seat cushion		1

ASSEMBLY INSTRUCTION

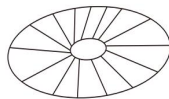
HARDWARE

NO	DESCRIPTION	SKETCH	QTY
1	Plastic gasket		4
2	Felt mat		4

PART LIST

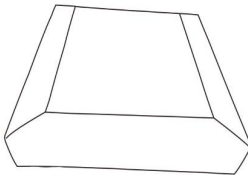
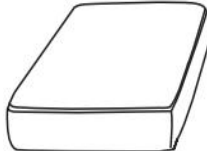
NO	DESCRIPTION	SKETCH	QTY
A	Main leg		4
J	Ottoman Seat frame		1
K	Ottoman Seat cushion		1

ASSEMBLY INSTRUCTION

All parts and hardwares

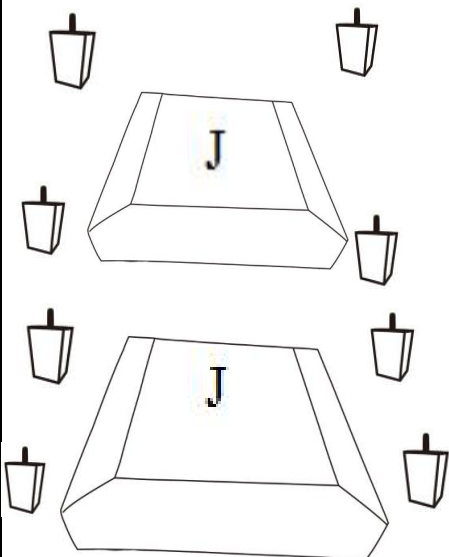
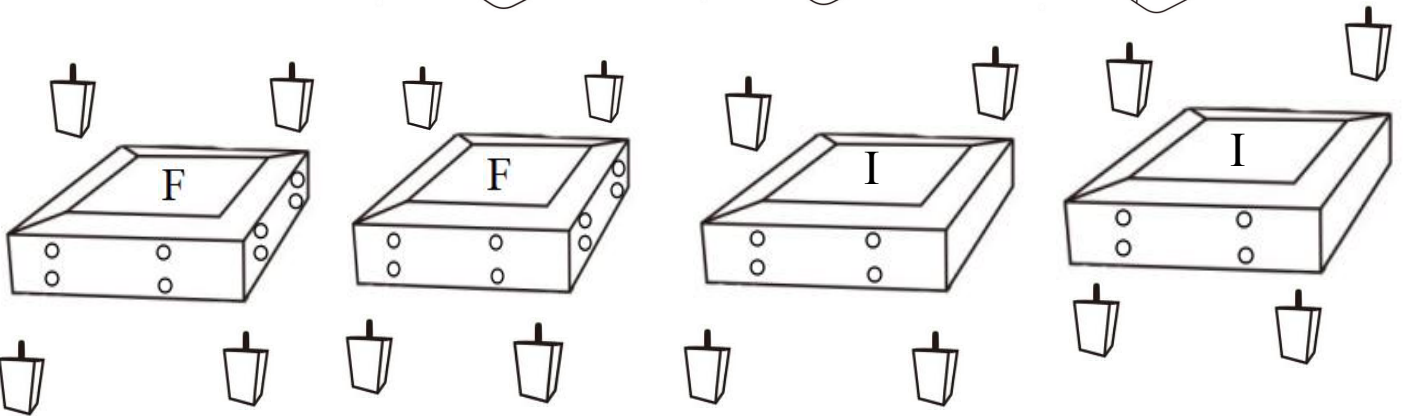
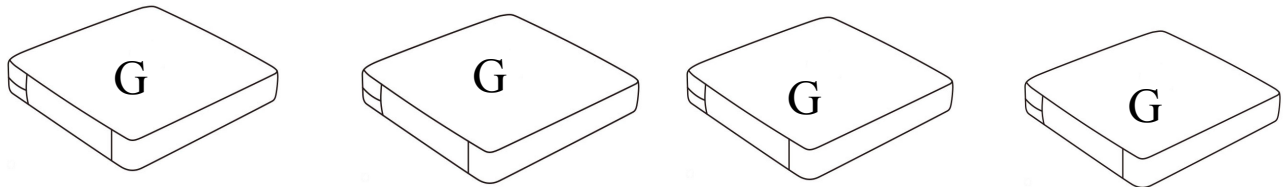
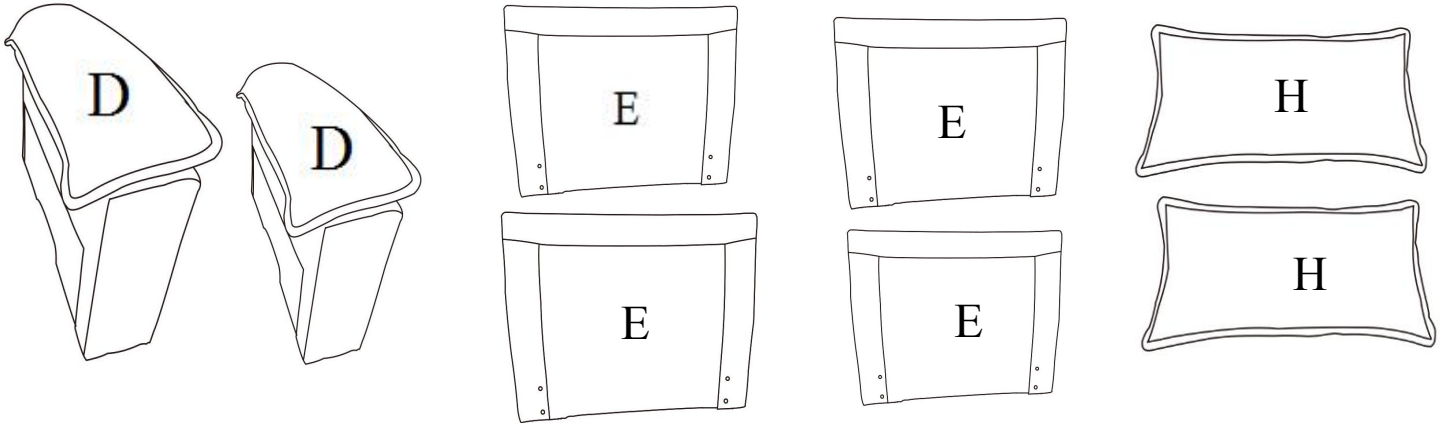
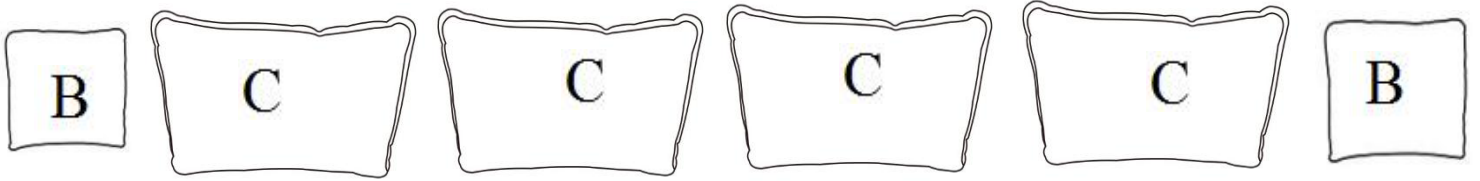

1		24
2		24
3		24
4		24
5		24
6		4
7		12

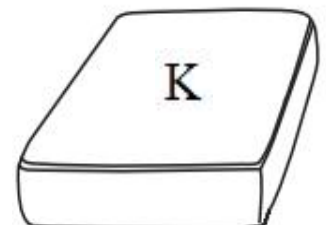
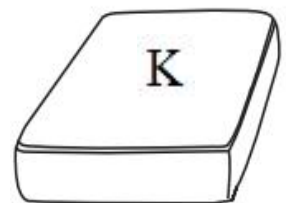

ASSEMBLY INSTRUCTION

DIAGRAM 1

Take the Main legs (Part A), Armrest pillow (Part B), Backrest pillow(big) (Part C), Seat cushion (Part G) out of the Seat frame (Part F).

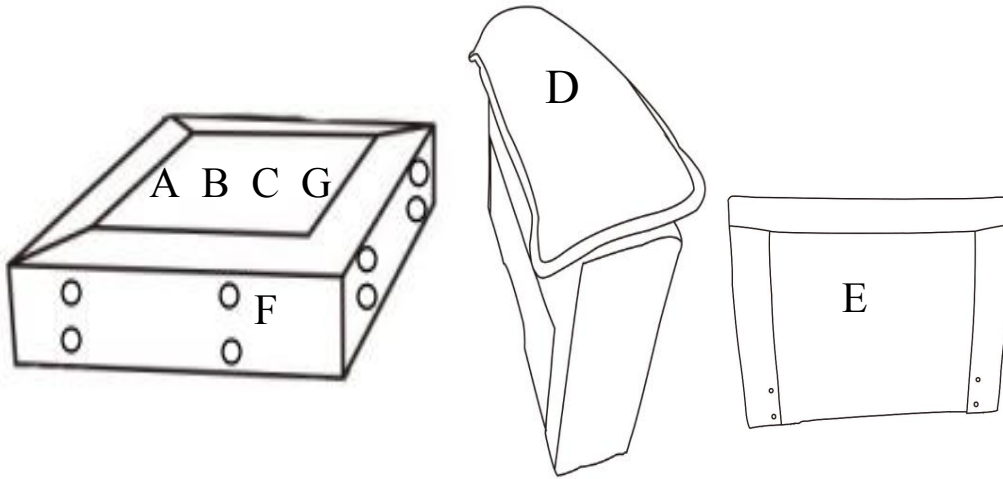

①		4
②		4
③		8
④		8
⑤		4
⑥		1
⑦		2

DIAGRAM 2 (Assemble the Backrest and Armrest)

Connect the Seat frame (Part F) and the Backrest (Part E) and the Armrest (Part D) with 8 Iron gasket 8*22MM (HARDWARE 3) and 8 Screws (HARDWARE 4) and 1 Wrench M6 (HARDWARE 6).

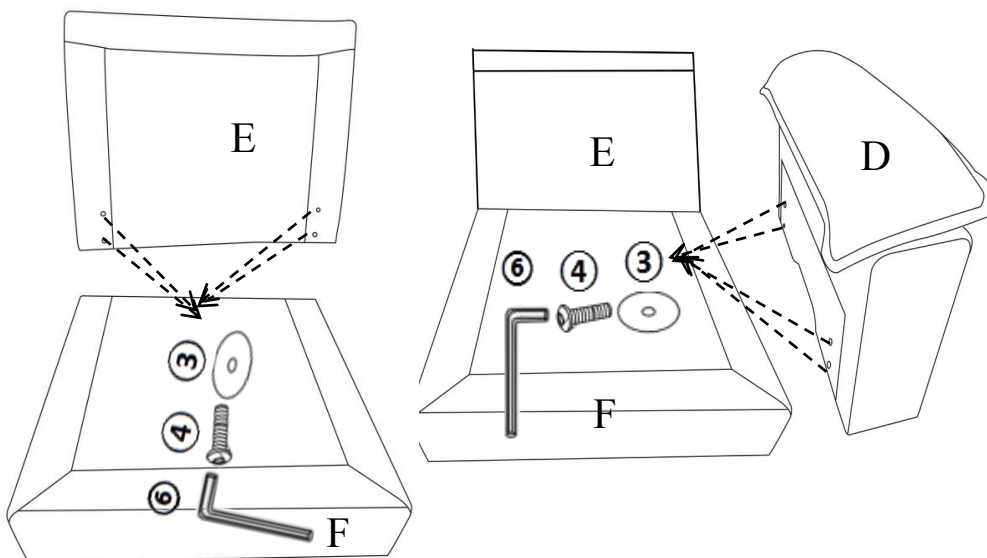

③		8
④		8
⑥		1

Please remember to assemble all the screws to 50% and finally lock them 100% .

ASSEMBLY INSTRUCTION

DIAGRAM 3

Use scissors to open the vacuum sealed Seat cushion (Part G). It may take 24-72 hours to fully expand back to its original shape and firmness.

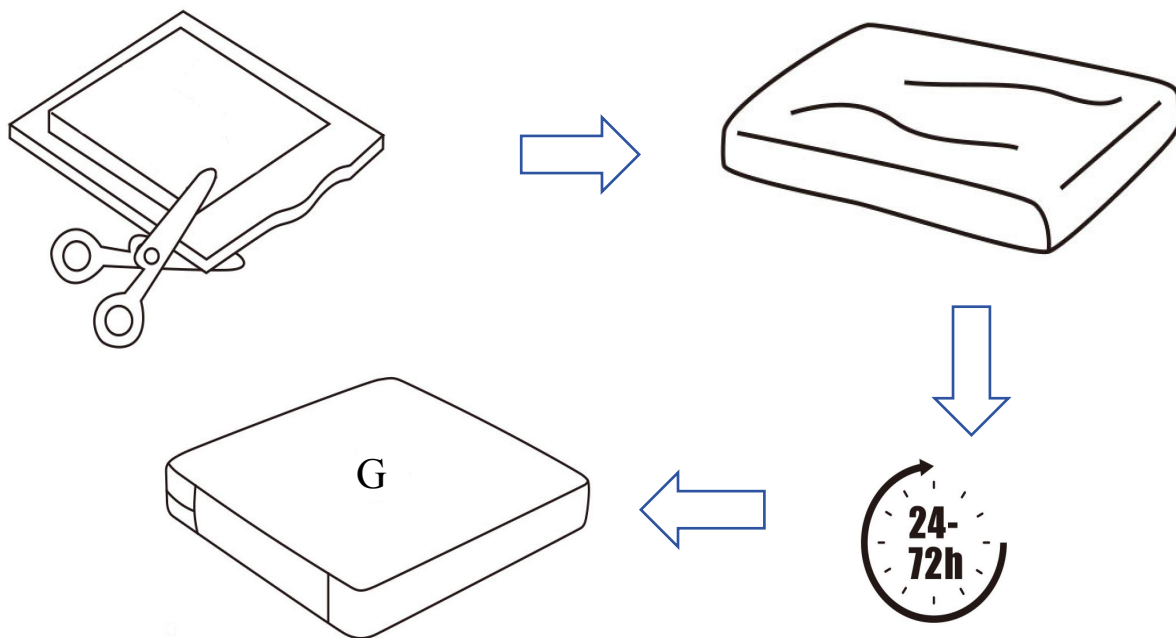
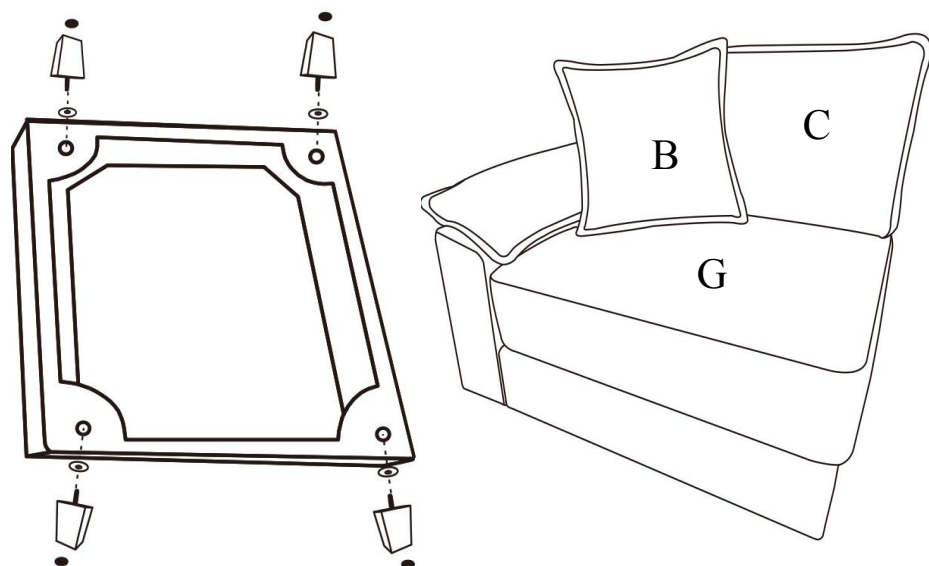

DIAGRAM 4

Tighten Main legs (Part A) by 4 Plastic gaskets (HARDWARE 1) . And then stick the 4 Felt mats (HARDWARE 2) under the Main legs (Part A). Put the Seat cushion (Part G) and Armrest pillow (Part B) and Backrest pillow (Part C) on the seat.



①		4
②		4
A		4

ASSEMBLY INSTRUCTION

DIAGRAM 5

Take the Main legs (Part A), Backrest pillow (big) (Part C), Backrest pillow (small) (Part H), Seat cushion (Part G) out of the Seat frame (with a backrest) (Part I).

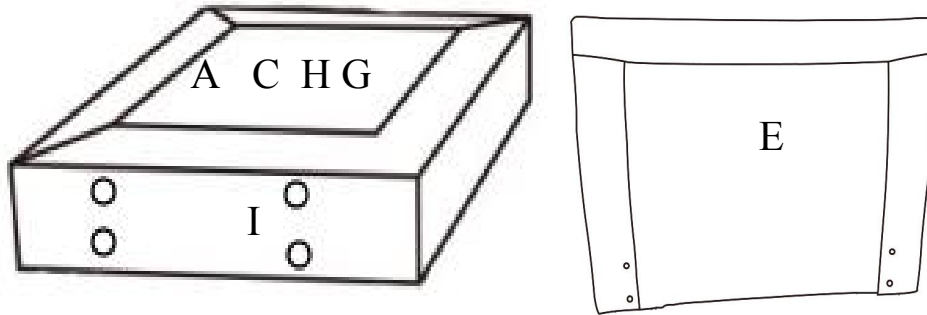

①		4
②		4
③		4
④		4
⑤		8
⑥		1
⑦		2

DIAGRAM 6 (Assemble the Backrest)

Connect the Seat frame (with a backrest) (Part G) and the Backrest (Part I) with 4 Iron gasket 8*22MM (HARDWARE 3) and 4 Screws (HARDWARE 4) and 1 Wrench M6 (HARDWARE 6).

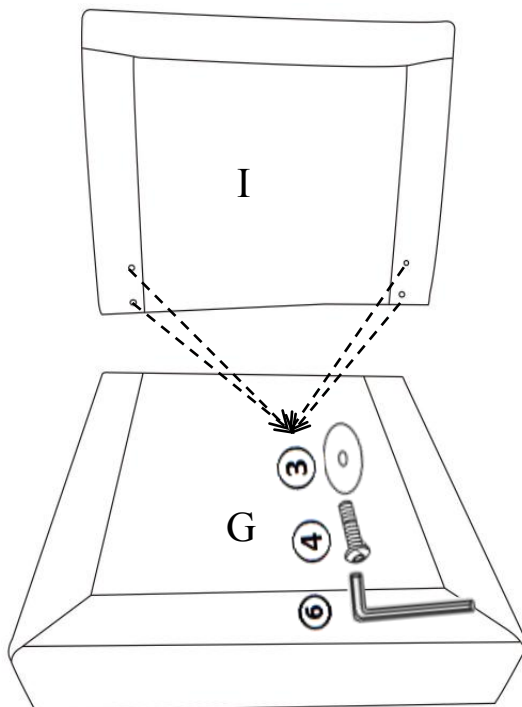

③		4
④		4
⑥		1

Please remember to assemble all the screws to 50% and finally lock them 100% .

ASSEMBLY INSTRUCTION

DIAGRAM 7

Use scissors to open the vacuum sealed Seat cushion (Part G). It may take 24-72 hours to fully expand back to its original shape and firmness.

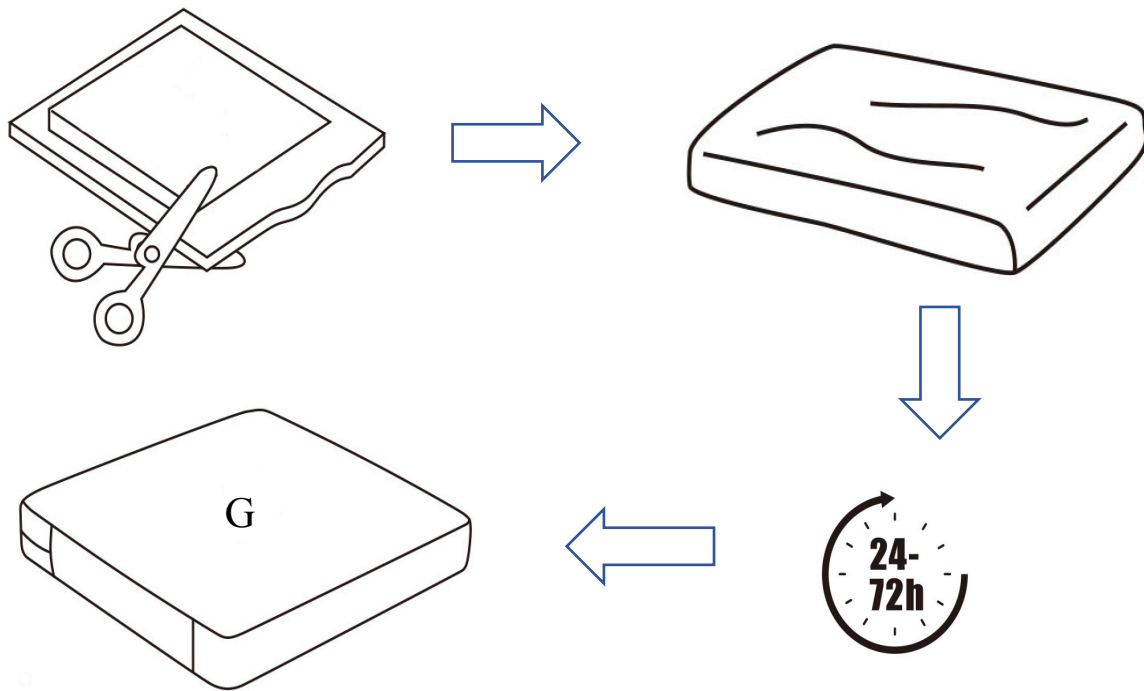
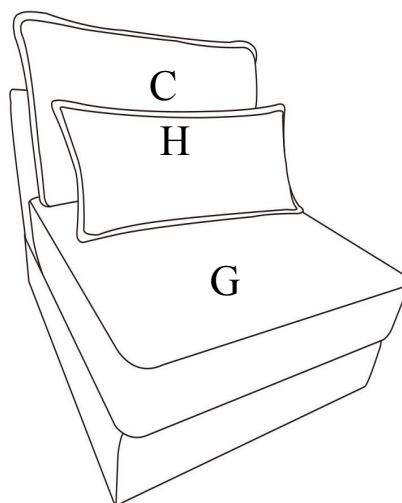
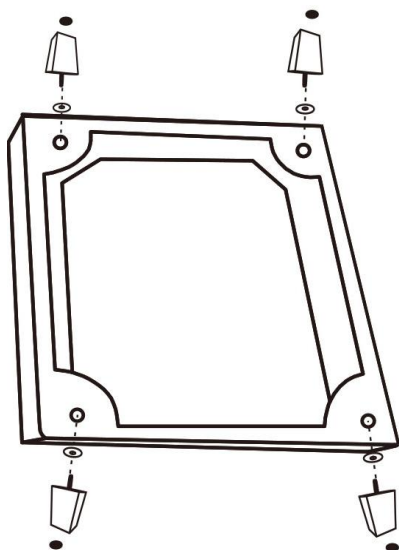

DIAGRAM 8

Tighten Main legs (Part A) by 4 Plastic gaskets (HARDWARE 1). And then stick the 4 Felt mats (HARDWARE 2) under the Main legs (Part A). Put the Seat cushion (Part G) and Backrest pillow (small) (Part H) on the seat.



①		4
②		4
A		4

ASSEMBLY INSTRUCTION

DIAGRAM 9

Take the Main legs (Part A), Ottoman Seat cushion (Part K) out of the Ottoman Seat frame (Part J).

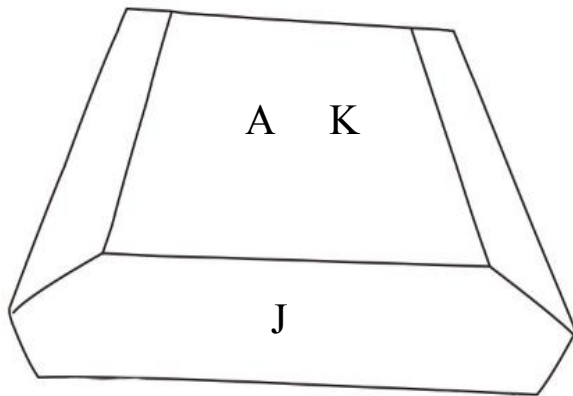



①		4
②		4

DIAGRAM 10

Use scissors to open the vacuum sealed Ottoman Seat cushion (Part K). It may take 24-72 hours to fully expand back to its original shape and firmness.

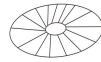

ASSEMBLY INSTRUCTION

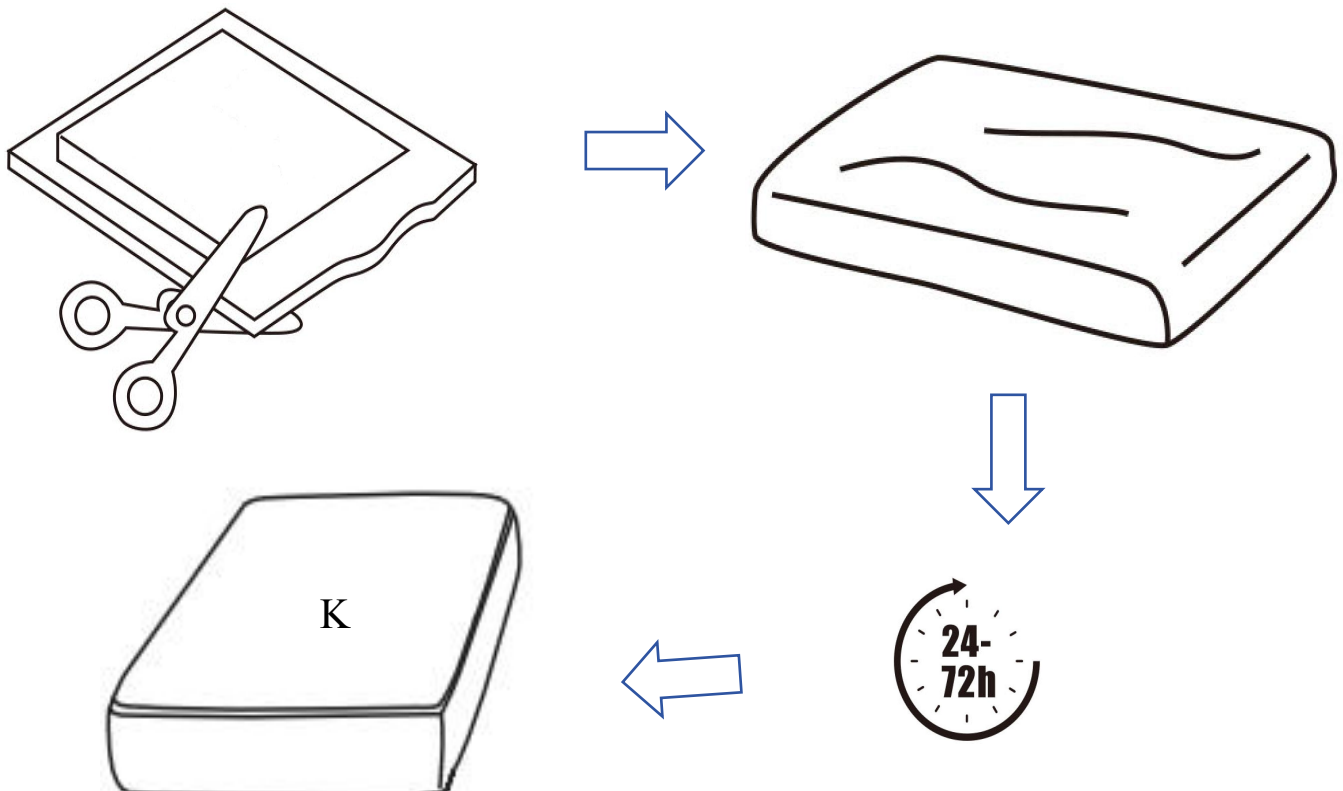
DIAGRAM 11

Tighten Main legs (Part A) by 4 Plastic gaskets (HARDWARE 1). And then stick the 4 Felt mats (HARDWARE 2) under the Main legs (Part A).

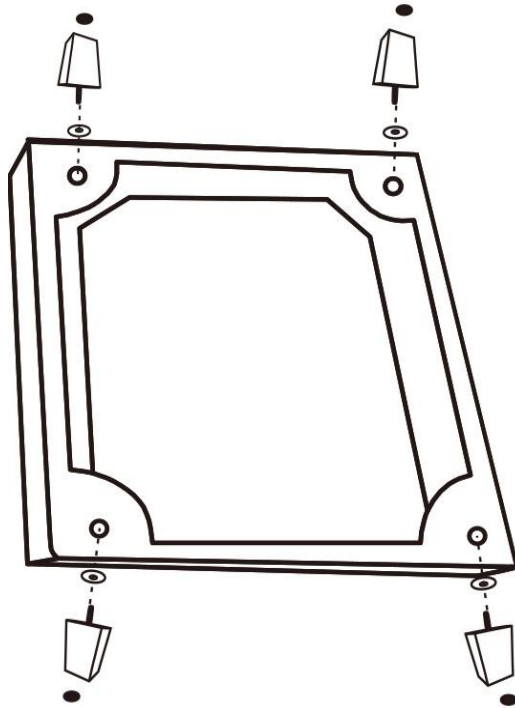



①		4
②		4
A		4

DIAGRAM 12

Put the Ottoman Seat cushion (Part K) on the Ottoman Seat frame (Part J).

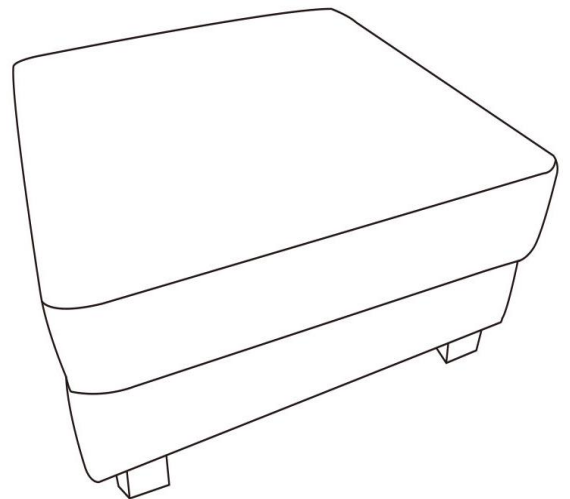
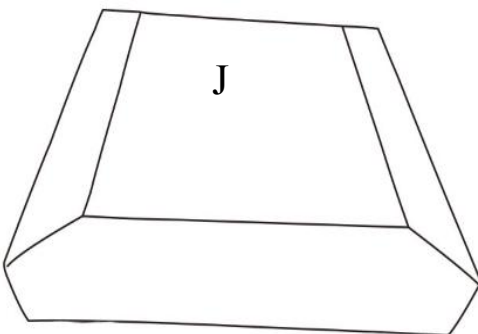
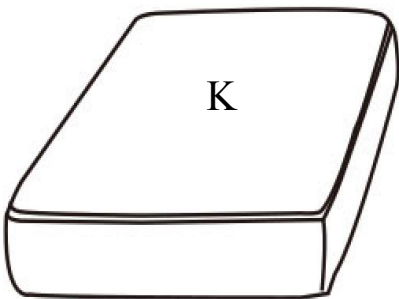

ASSEMBLY INSTRUCTION

DIAGRAM 13

Use the 12 Inserts (HARDWARE 7) connect the Seat frame (Part F) and the Seat frame (with a backrest) (Part I) with 24 Screws (HARDWARE 5) and 1 Wrench M6 (HARDWARE 6).

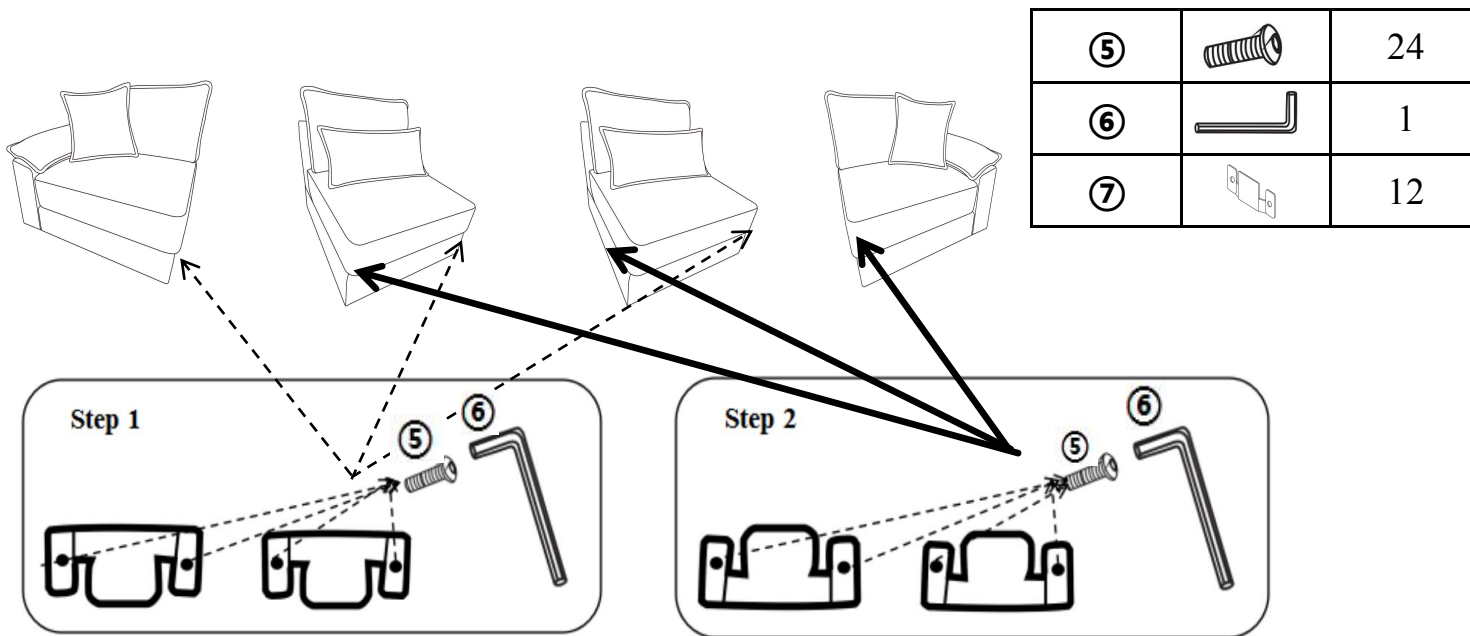
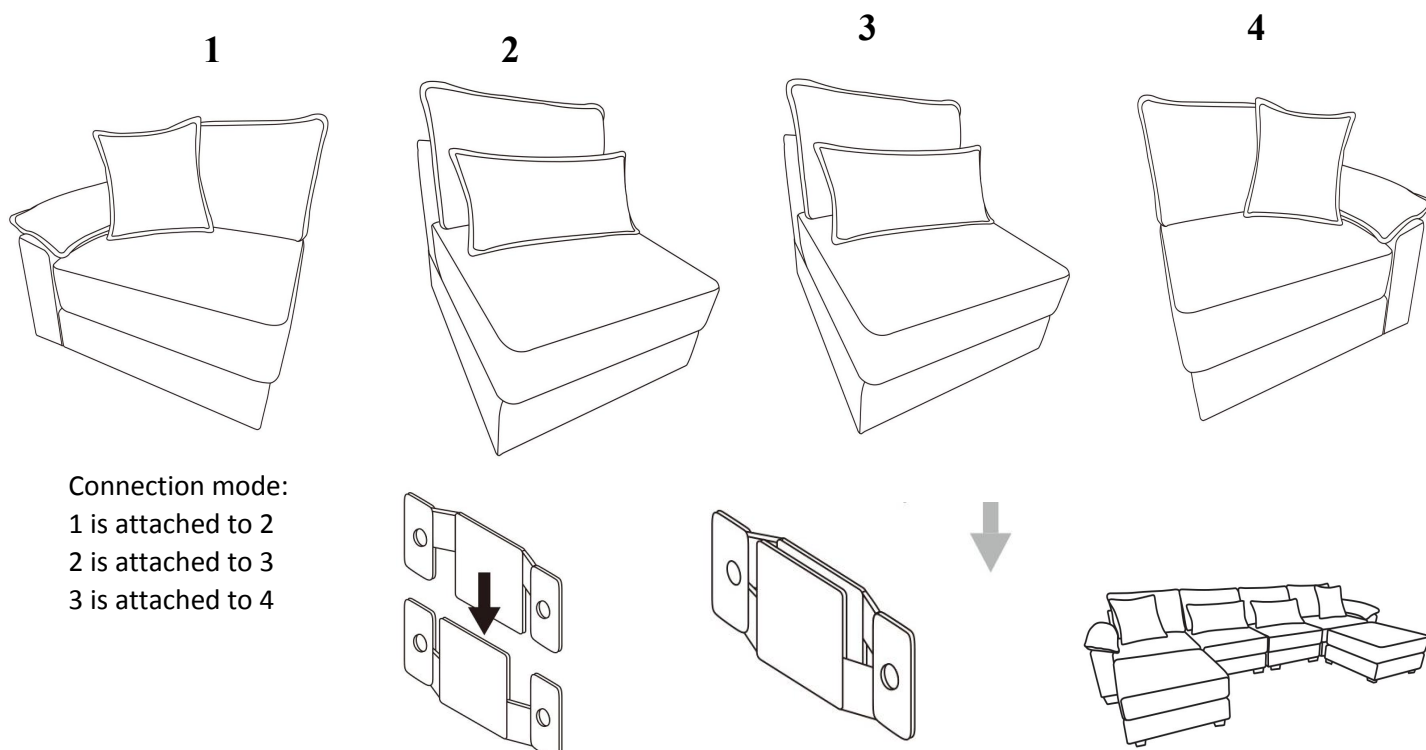

DIAGRAM 14

Connect the Seat frame (Part F) and the Seat frame (with a backrest) (Part I).



ASSEMBLY INSTRUCTION

TIPS:

1. Please do not open the compress packaging until your sofa frame is completely assembled.
2. Compress back cushions and pillows need to be fully fulfilled within 72 hours for your perfect use.
3. Please keep children away from plastic bags or any small pieces of stuff.

