

Cloud Sectional Couch

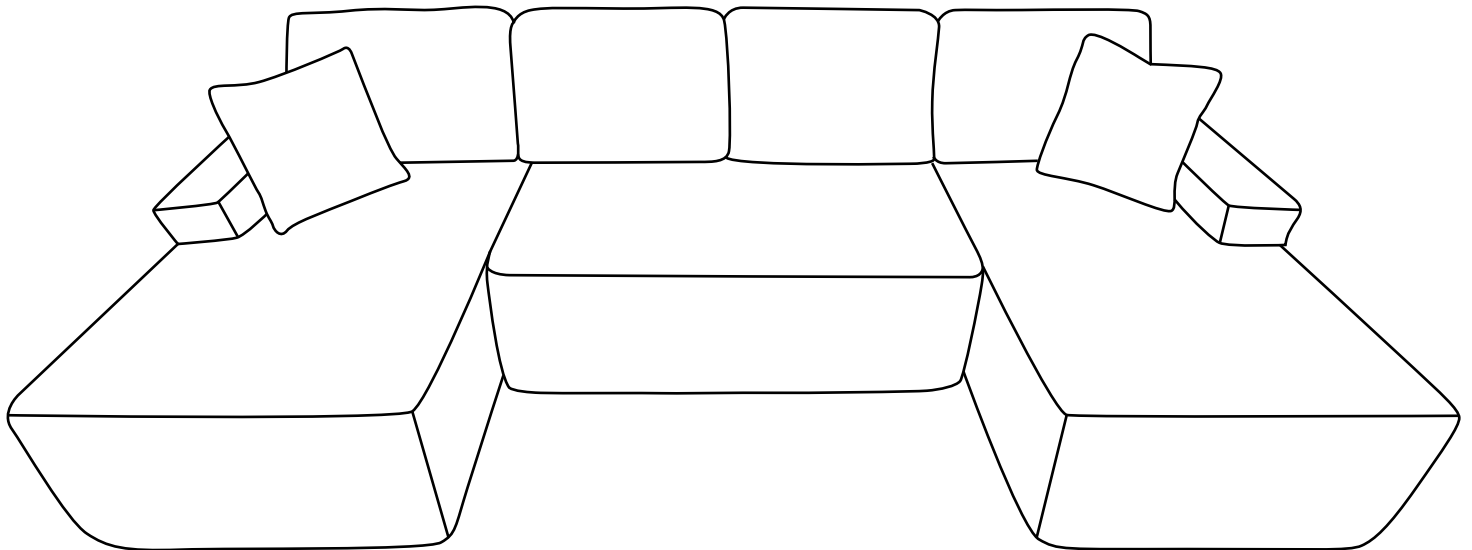

HOW MANY PACKAGES INCLUDED?

3 Boxes (A/B/C)

ASSEMBLY REQUIREMENT

No tool assembly required

Simply unpack the box, cut open the packaging, wait for the foam to expand and splice the sofa

Thank you for purchasing our sofa, if you have any questions, please contact us, we will provide the best solution as soon as possible.

Box A Parts List

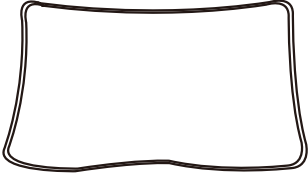
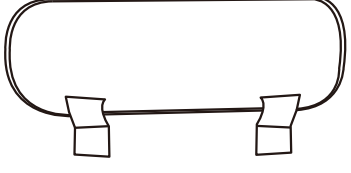
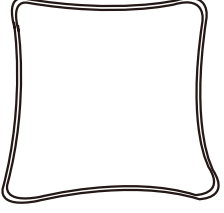
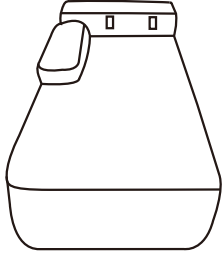
B  1PCS	C  1PCS	D  1PCS
L  1PC		

Box B Parts List

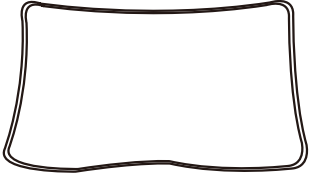
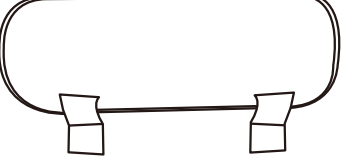
A  1PC	B  2PCS	C  2PCS
--	---	---

Box C Parts List

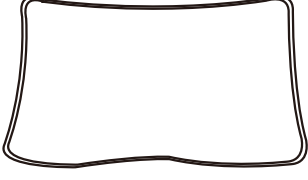
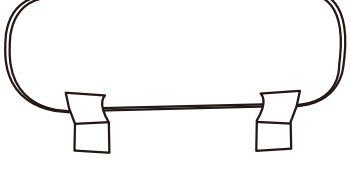
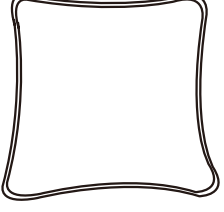
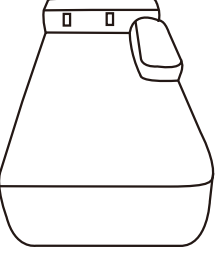
B  1PCS	C  1PCS	D  1PCS
R  1PC		

STEP 1 Take the compressed foam sofa out of the box

STEP 2 Cut open the compressed package, please cut carefully

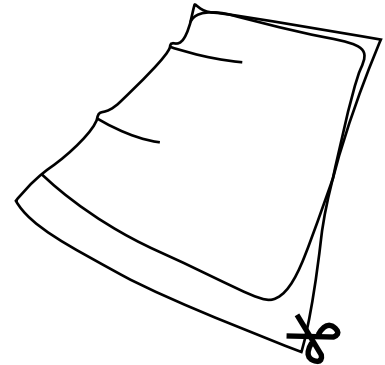
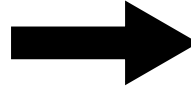
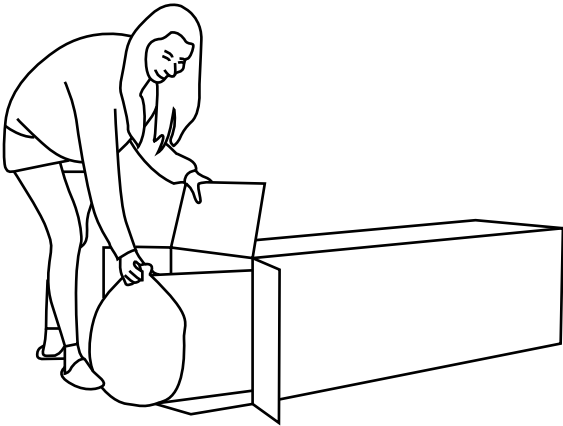

STEP 3 Splice the sofa body together

NOTE: Due to the vacuum packaging, the foam is compressed and it takes about 3-7 days to return to the original state of the sofa

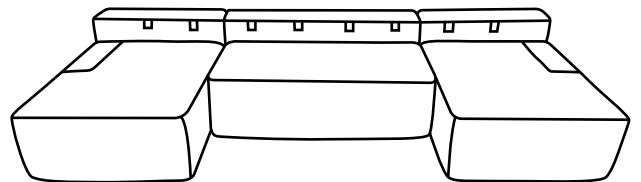
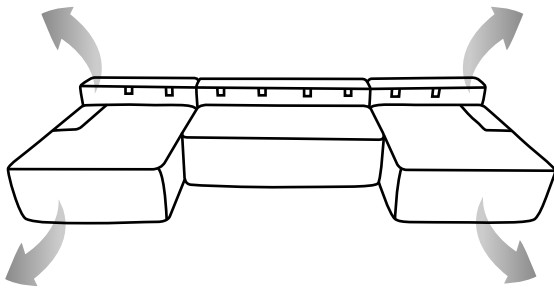

STEP 4 The cushion needs air to regain its shape, you could also pat it with your hand to make it regain its shape faster

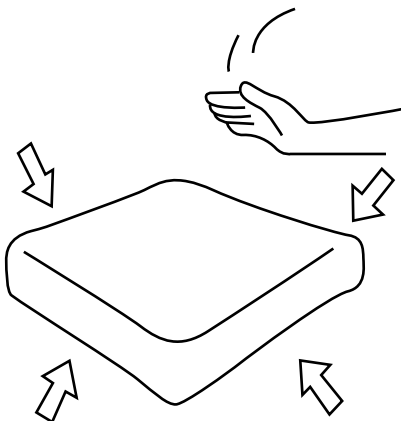

pat around evenly plump

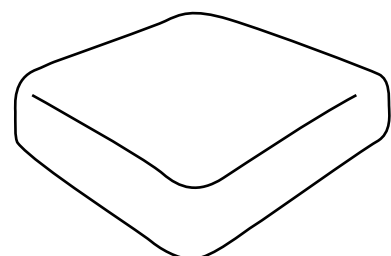

STEP 5 Put armrests on the left and right sides of the sofa, just zip it up

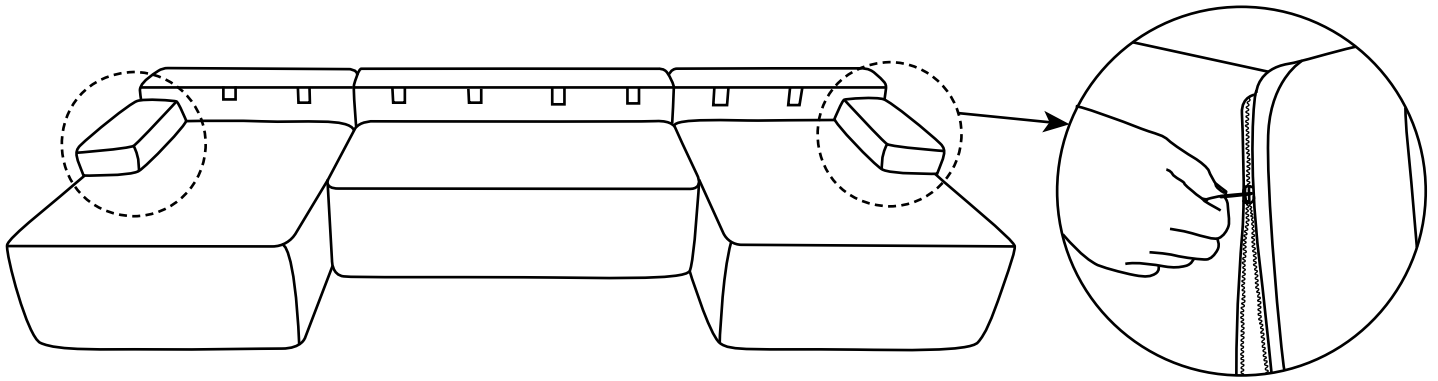

STEP 6 Support pillows secured with Velcro

The support pillow can be adjusted according to the position of the Velcro

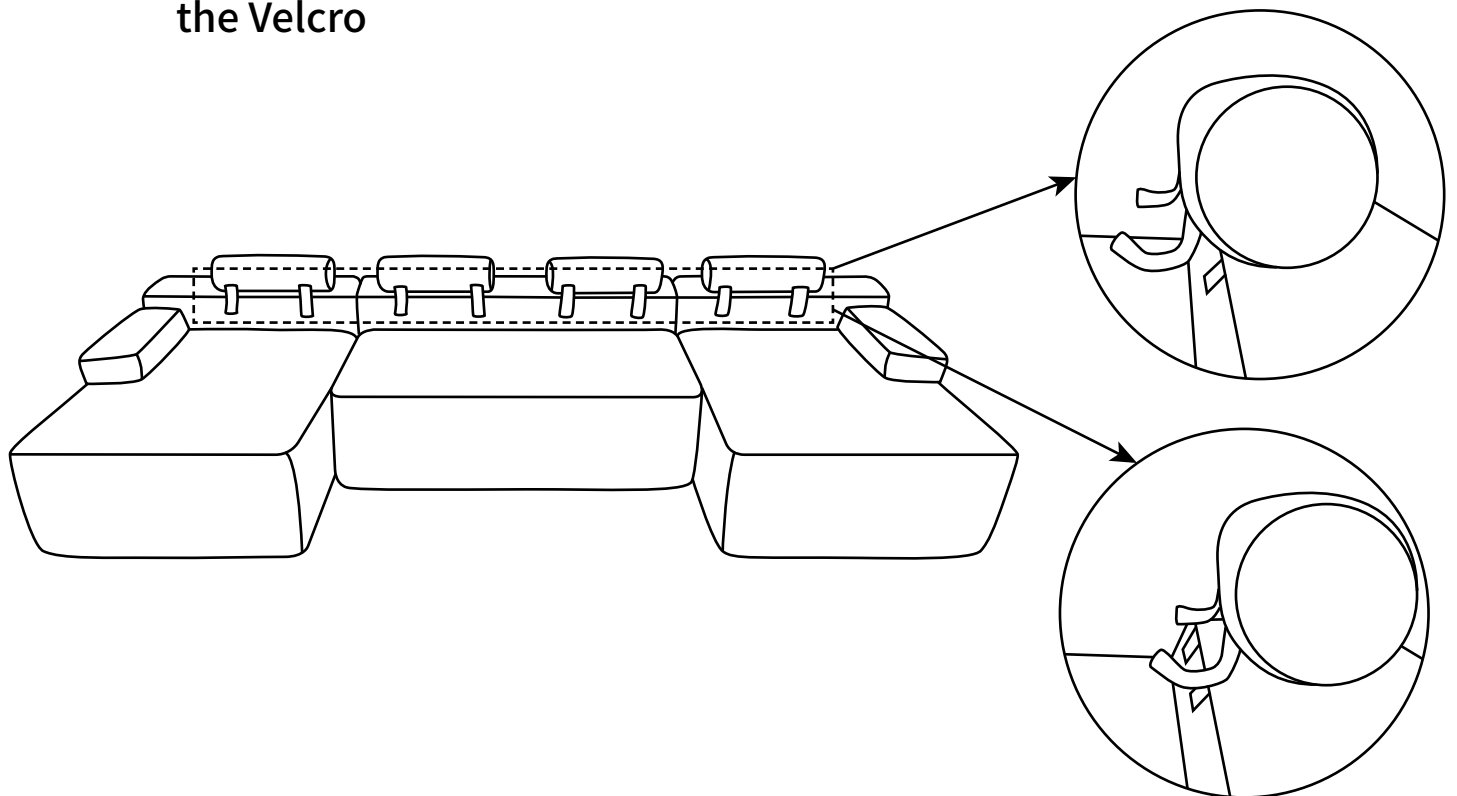

STEP 7 Put the backrest pillow on

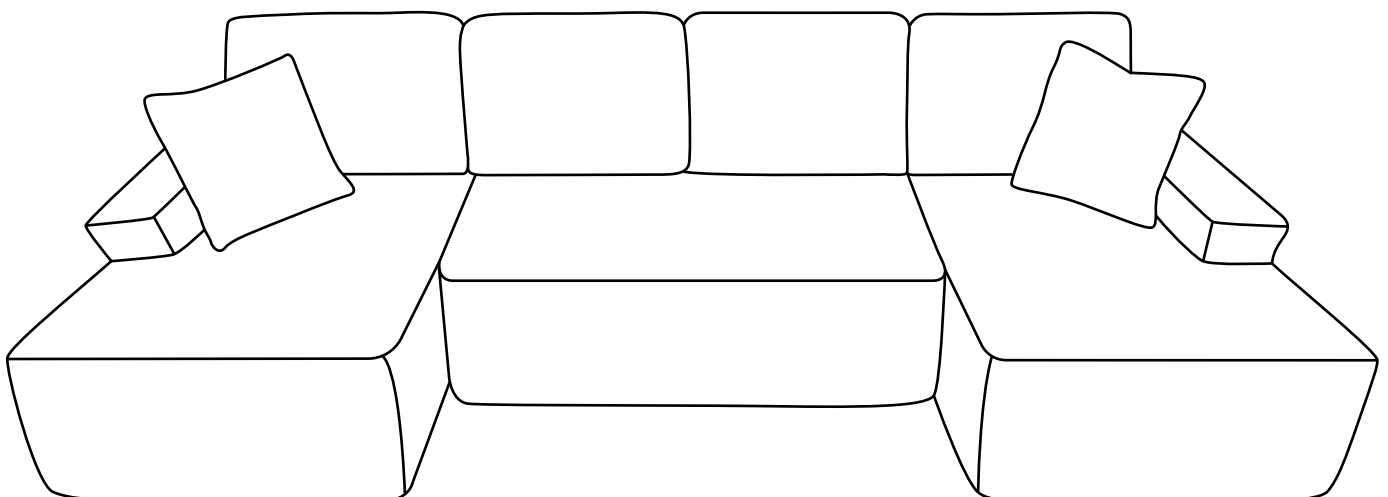

Combination Method

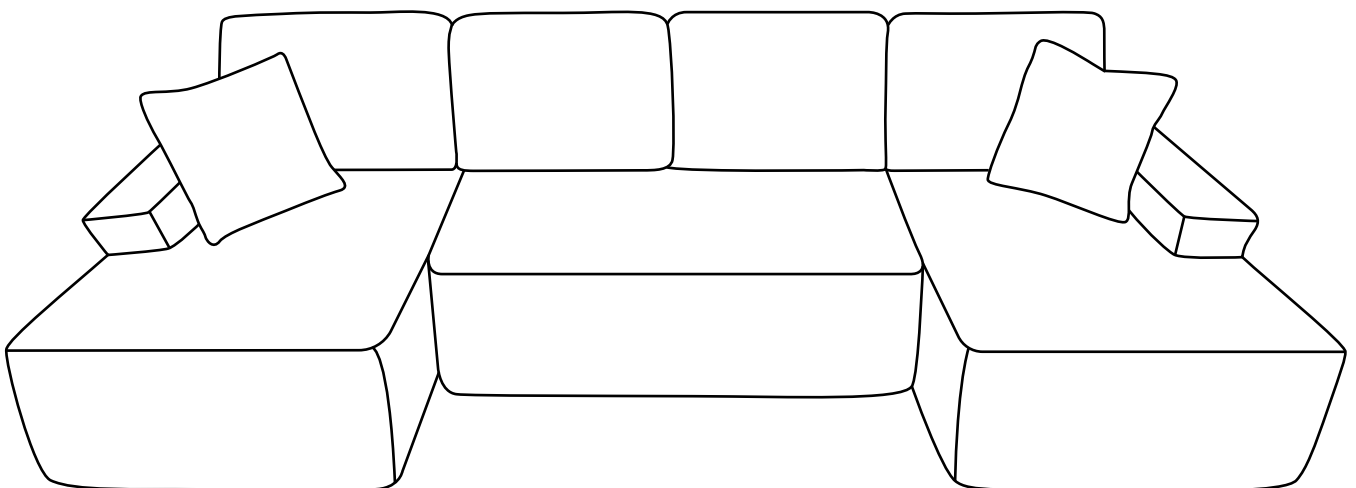
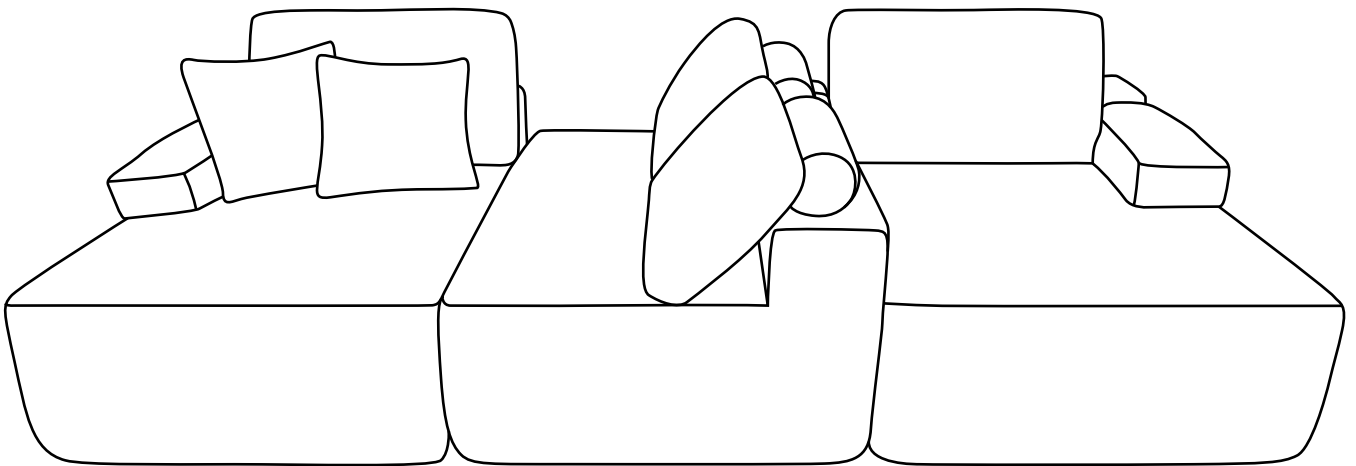
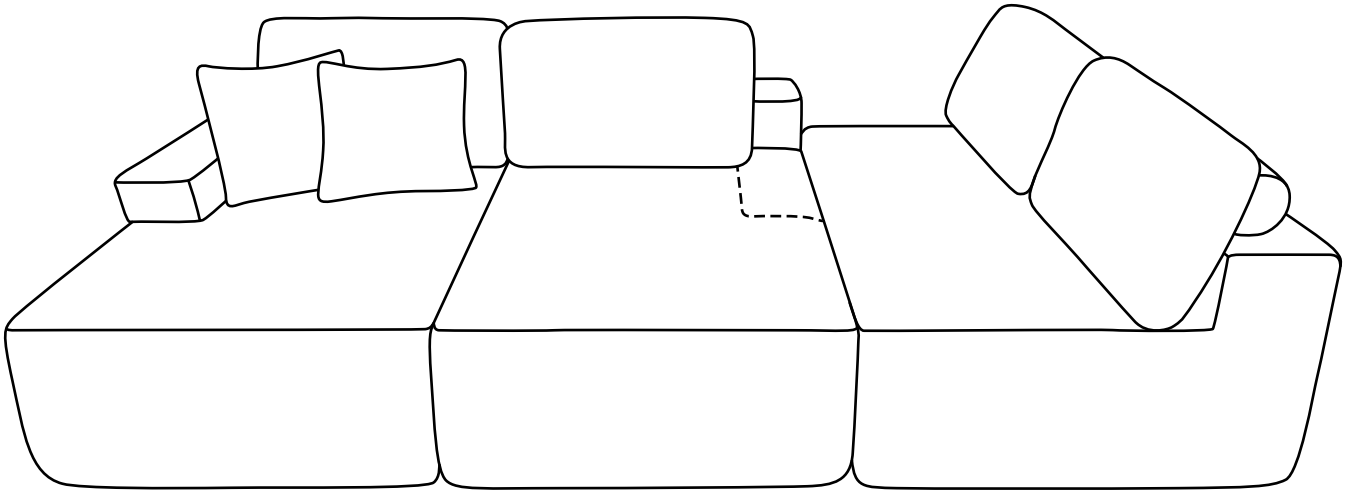

Sofa Return Policy

Returns are allowed within 30 days of the date you received the product. To submit a return request, please message us with your order ID and the reason for returning it so we can process the request and issue return authorization to you as soon as possible. Please be noted the return policy is subject to the conditions below:

1. Please don't unpack the vacuum-compressed packages before you don't decide to keep the sofa. Because the vacuum-compressed packages cannot be repacked and returned after being unpacked.

2. Important: Items must be in new or like-new condition to be eligible for returns. Original packaging must be retained and used in the event of a return.

If an item is returned WITHOUT the original packaging, a repacking fee (\$50) will be deducted from the refund.

3. The customer should return all accessories from its original shipment. It is your responsibility to pack the item sufficiently to avoid damage in transit back to us. We encourage customers to photograph the items scheduled for return and the condition of the packaging before handing them over to the delivery company.

4. Once the item is back at our warehouse, it will be inspected by our team. If the quality of returned products is acceptable, we will issue you a refund minus the original shipping cost you paid on the order within 48 hours. All returned items will receive a full refund back to the original payment method.