

Ceiling Fan
Installation Instruction



SAFETY INFORMATION

Please read all safety information and instructions before installing the ceiling fan and save this manual for future reference.

| | |
|---------------------------------|-----------|
| SAFETY INFORMATION | 01 |
| PRE-INSTALLATION | 02 |
| PARTS LIST | 03 |
| INSTALLATION INSTRUCTION | 03 |
| OPERATION INSTRUCTION | 05 |
| TROUBLESHOOTING | 07 |

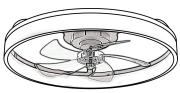

SAFETY INFORMATION



WARNING

- Before connecting the power supply, make sure that the power supply used matches the specifications of the ceiling fan.
- All wiring must comply with national and local electrical codes ANSI/NFPA70. If you are not familiar with wiring, please use a qualified electrician.
- To reduce the risk of fire or electric shock, turn off the power to the fuse box or circuit breaker before installing the fan.
- To reduce the risk of personal injury, attach the fan directly to the building's support structure and ensure that it can accept at least 35 pounds (15.9 kg).
- Make sure that the installation location allows the fan blades to rotate without obstacles.
- Not compatible with sloped ceilings

Installation Location

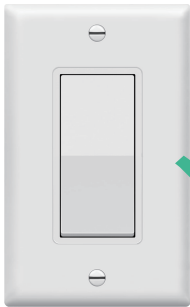
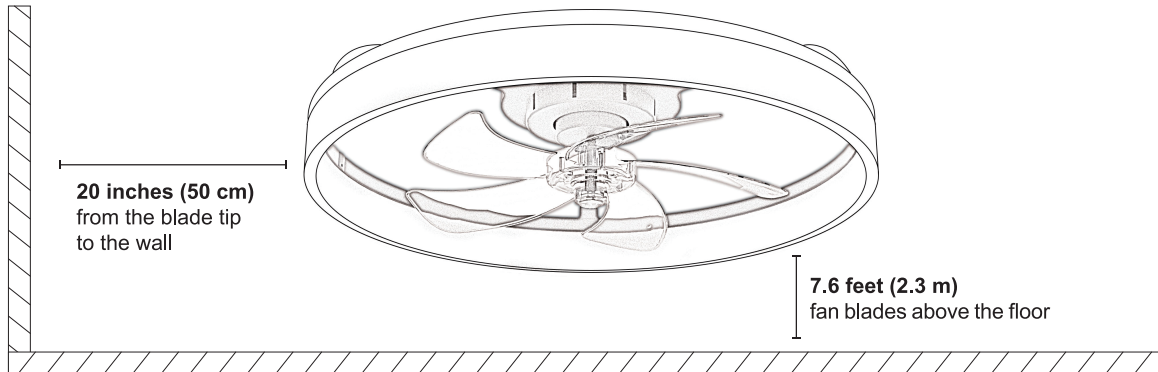

WARNING

- Do not operate this fan with a variable (Rheostat) wall controller or dimmer switch.
- Doing so could result in damage to the ceiling fan's remote control unit.

PRE-INSTALLATION

Tools Required (Not Included)



Power Drill

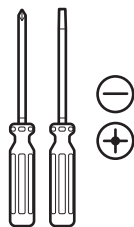

Screwdriver

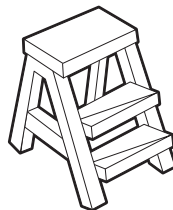

Step Ladder



Wire Stripper

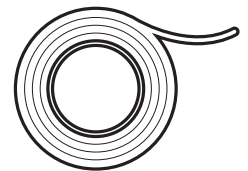

Electrical Tape

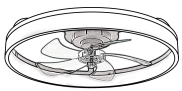

PARTS LIST



Remote Control



01. Mounting Bracket



02. Ceiling fan light

INSTALLATION INSTRUCTION

Step 1: Mounting Bracket installation

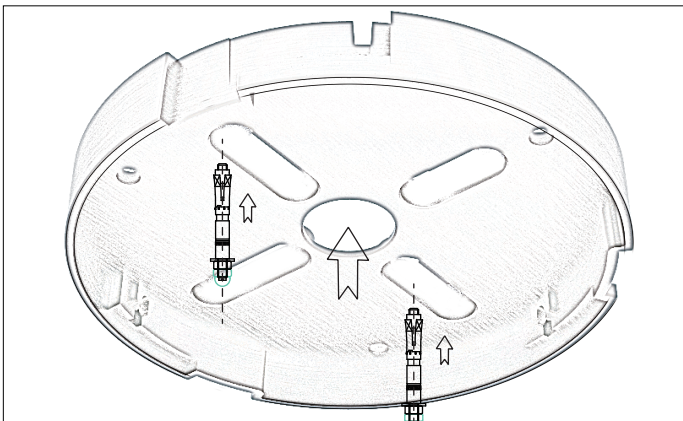

For the concrete ceiling:
Begin by marking the location on the ceiling. Then, use the 2 expansion screws provided to drill 2 holes in the ceiling, which will help secure the ceiling bracket. Attach the mounting bracket to the building structure using the 2 expansion screws provided, and tighten them firmly.
Only applicable to flat ceilings, not compatible with sloped ceilings.

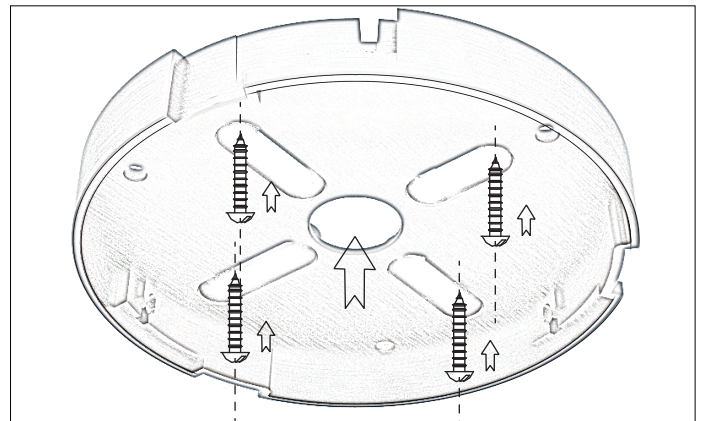

For the wood ceiling:
Start by marking the location for the ceiling fan. Then, use the 4 wood screws provided to securely attach the mounting bracket to the building structure.



Step 2: Ceiling Fan installation



① Use S hook to hang the fan light for easy installation.

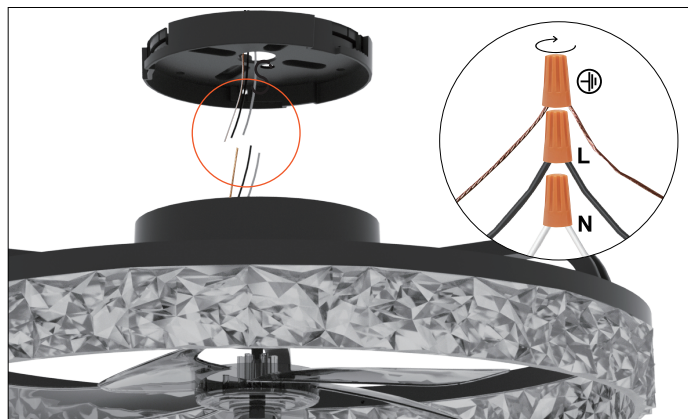

③ The receiver is connected to the motor power cord and the ceiling power cord respectively.



② Lift the fan light and rotate it clockwise to secure it to the bracket.

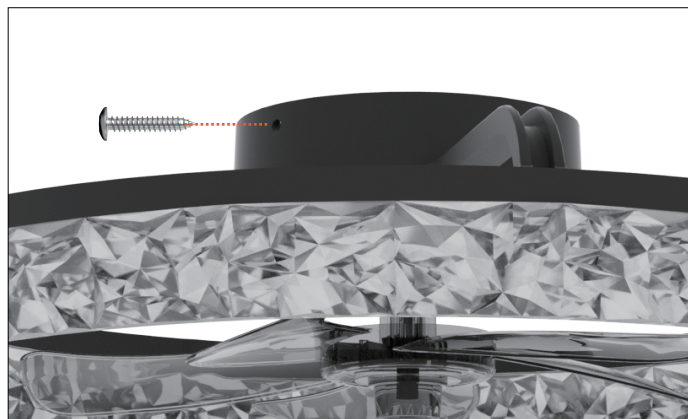

④ Fixed and locked with screws from the side of the ceiling tray.

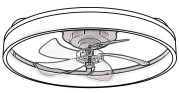

OPERATION INSTRUCTION

How to Operate Your Ceiling Fan

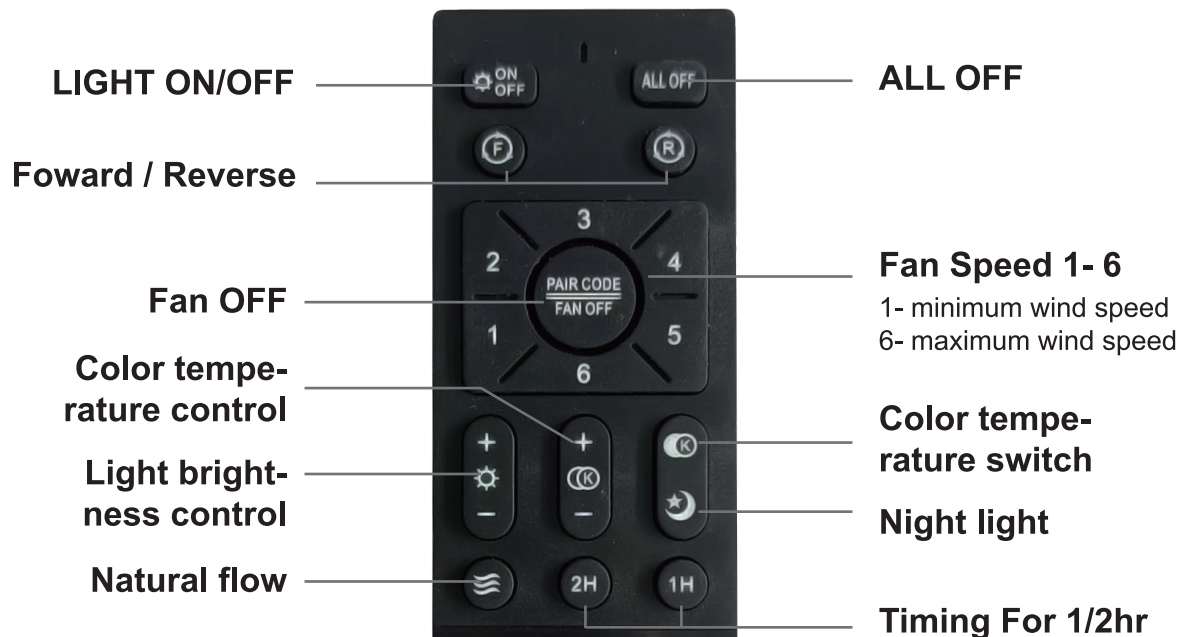

Remote Control



Points For Attention

- **Install 1.5*2 volt battery**(Not included)
(To prevent damage to transmitter, remove the battery if not used for a long time)
- **Do not place the remote control in an excessively hot or humid environment**
- **Remote control learning code method:**
Your remote control and ceiling fan light have been successfully paired initially. If you find that the remote isn't working properly during use, you can re-pair them by following these steps:

Step 1: Turn off the wall control switch.

Step 2: Turn on the wall control switch, within 5 seconds of the fan light lighting, press and hold the "**PAIR CODE**" for 5 seconds until you see the fan light flash twice. This indicates that the pairing process has been successfully completed.



How TO Use the Mobile APP

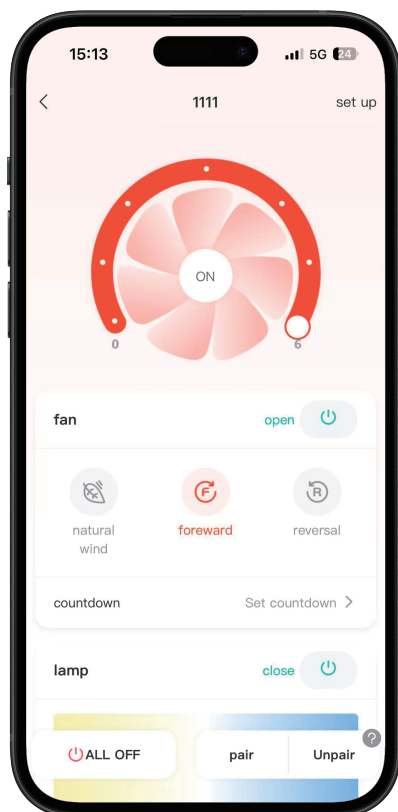

Scan the QR code to download the remote control app.

App Control



Points For Attention

- **Connecting with mobile phone APP**

Scan the QR code to download the "Zhi kong Pro" APP.



Make sure that your Bluetooth are enable when using the Smart Home Light.



Bluetooth connection

Power off the receiver for 5 seconds Turn on the power and immediately press the key of " pair " for The light flashes twice then learn successfully.

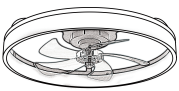

TROUBLESHOOTING

Warning: For your own safety turn off power at fuse box or circuit breaker before troubleshooting your fan.

| TROUBLE | Probable Cause | Suggested Remedy |
|--|--|---|
| FAN AND LIGHT DO NOT WORK BUT WIRES CONNECTED WELL | The AC power from wall controller or dimmer switch. | Do not operate this fan with a variable (Rheostat) wall controller or dimmer switch. Choose the switch as this introduction showed. |
| FAN WILL NOT START | <ol style="list-style-type: none"> 1.Fuse or circuit breaker blown. 2.Loose power line connections to the fan, or loose switch wire connections in the switch housing. 3.Reversing switch in neutral position. 4. Dead battery in remote control. | <ol style="list-style-type: none"> 1.Check main and branch circuit fuses or circuit breakers. 2.Check line wire connections to fan and switch wire connections in the switch housings. CAUTION: Make sure main power is turned off! 3.Make sure reversing switch position is all the way to one side. 4.Replace with new battery. |
| FAN SOUNDS NOISY | <ol style="list-style-type: none"> 1.Loose screws in motor housing. 2.Wire connectors inside housing rattling. 3.Motor noise caused by solid state variable speed control. | <ol style="list-style-type: none"> 1.Check to make sure all screws in motor housing are snug (do not overtighten). 2. Check to make sure wire connectors in switch housing are not rattling against each other or against the interior wall of the switch housing. CAUTION: Make sure main power is turned off! 3.Some fan motors are sensitive to signals from solid-state variable speed controls. Solid-state controls are not recommended, choose an alternative control method. |
| FAN WOBBLERS EXCESSIVELY | <ol style="list-style-type: none"> 1.Setscrew in downrod support is loose. 2.Setscrew in downrod/hanger ball assembly is loose. 3.The groove hanger ball not lined up with the tab. 4.Hanger bracket and/or ceiling outlet box is not securely fastened. | <ol style="list-style-type: none"> 1.Tighten both setscrews securely in downrod support. 2.Tighten the setscrew in the downrod/hanger ball assembly. 3.Re-hanging the hanger ball secure the tab into the groove. 4.Tighten the hanger bracket screws to the outlet box, and secure outlet box. |