

E10# Partition shelf construction elucidation diagram





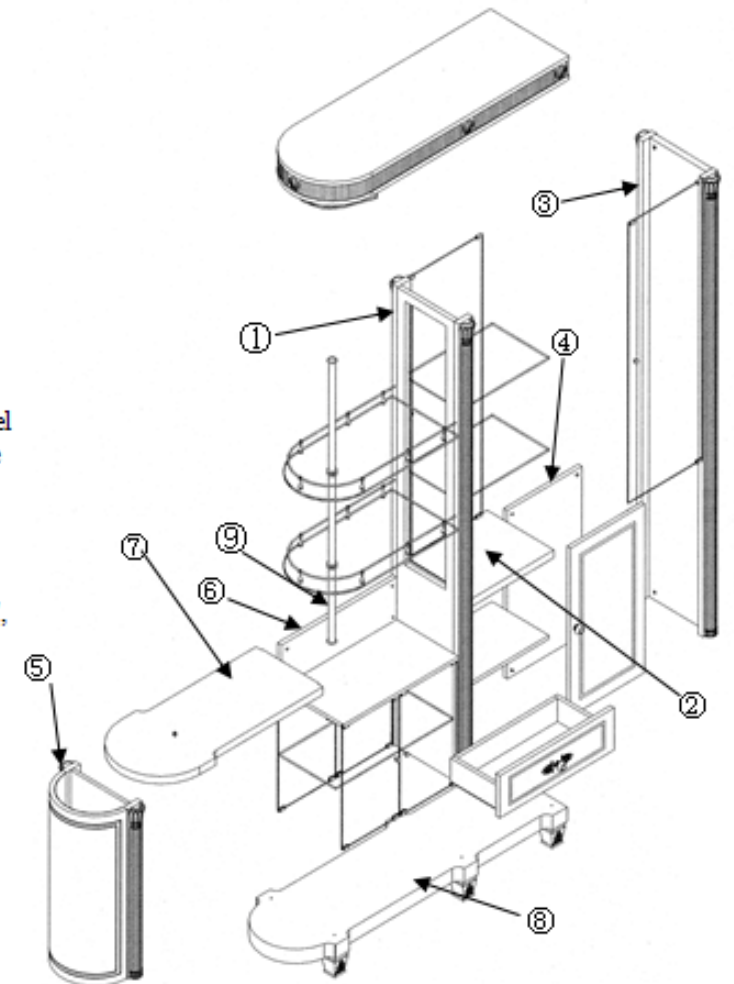

Packing box :

- 5---1 A scaleboard, medium side;
- 5---2 Long side plank;
- 5---3 Short side plank, door;
- 5---4 Drawer;
- 5---5 Glass lamination.

Installation steps:

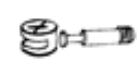
1. Use long side plank 1 first medium front-panel 2 with 3 conjunctions of the side plank, then use a plank 4 conjunction, lock up to lack of impartiality the piece;
2. Short side plank 5 use false take out 6 conjunctions of plank, then pack the top plank 7, lock the tight partiality piece;
3. Pack up the scaleboard 8;
4. install the medium pillar 9 and glass lamination;
5. Pack up the movable lamination;
6. Pack the last plank and glass door, drawers finally.

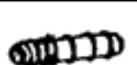

	NAME	Demensioll	Qty	Picture
1	The glass clip.		6set	
2	Hold hands	18L	6pcs	
3	3 into 1	25L	28set	
4	Wood	Φ 8*40	32pcs	
5	Lamination grain		16pcs	
6	Iron		7set	
7	Light	20W	2set	