







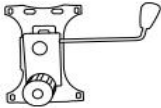

ASSEMBLY INSTRUCTION

PARTS #	DESCRIPTION		QTY
A	Five Star Foot		1
B	Pneumatic Rod #80		1
C	Tray		1
D	Casters		5
E	Flat Washer M6*18MM		4
F	Flash Washer M6		4
G	Long Bolt M6*20MM		4
H	Allen Key 5MM		1

1. Take out Five Star foot, Pneumatic rod, Tray . Press the caster (D) into five star foot (A). Lock the legs by using flash washer (F), flat washer (E), bolt (G). Then tighten the bolts with an allen key (H).



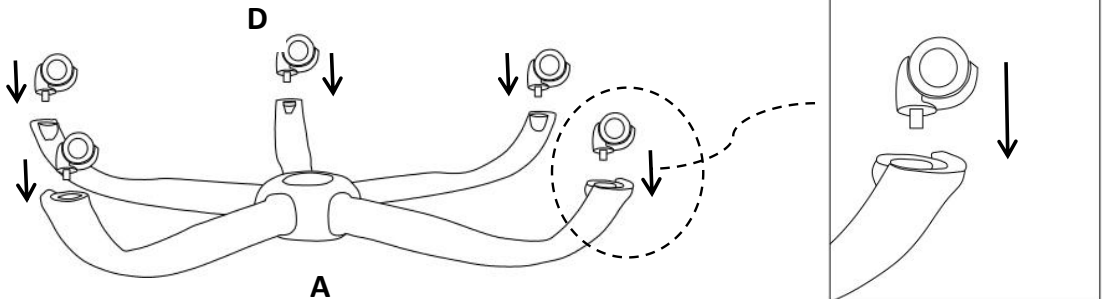
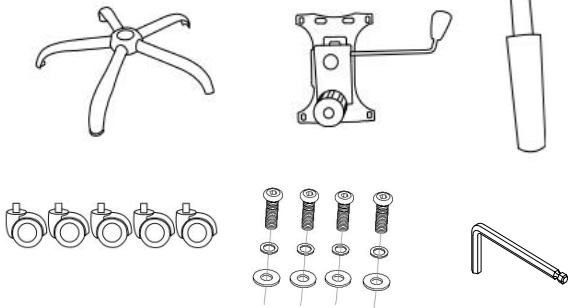
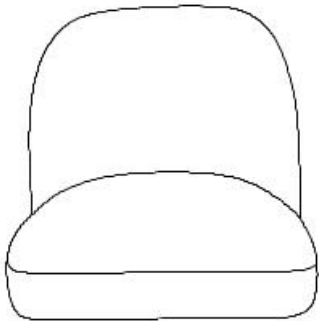
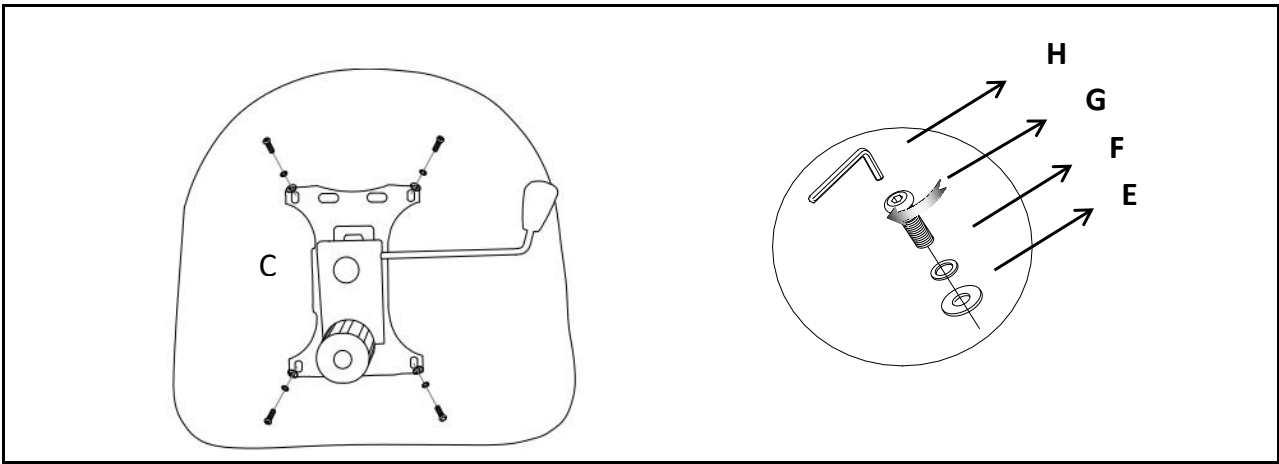

2. Press the Pneumatic Rod into the Five Star Foot and Tray.

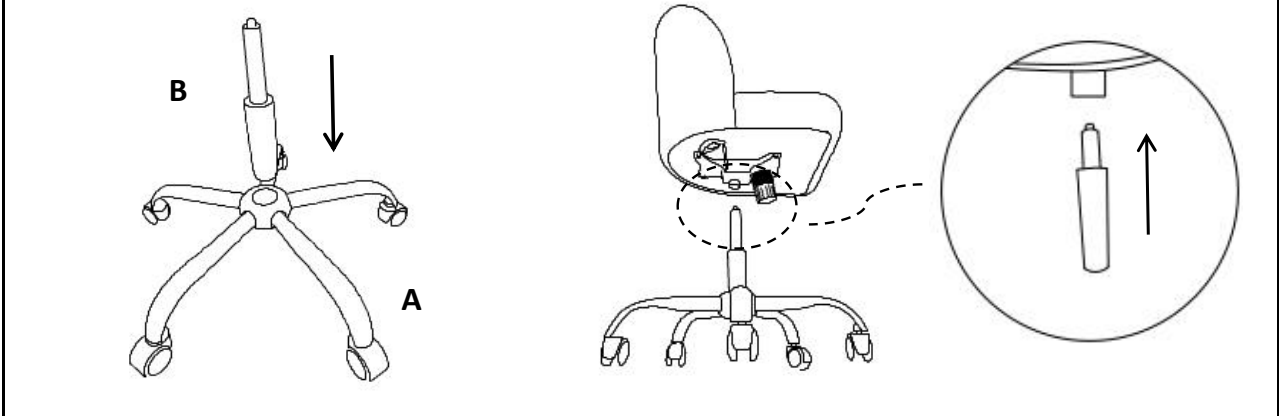

3. Level the chair and place it upright on a level surface.

